

- NOTES
1. WIRING LEGEND:
 DISTANT TERMINATING AREA
 DISTANT TERMINAL DESIGNATION
 WIRE COLOR CODE
2. COLOR CODE:
 BK-BLACK P-PURPLE W-WHITE-BLACK R-R-WHITE-PURPLE
 BL-BLUE S-RED W-WHITE-BLUE R-R-WHITE-RED
 BR-BROWN S-SLATE W-BR-WHITE-BROWN W-W-WHITE-SLATE
 G-GREEN Y-YELLOW W-W-WHITE-GREEN R-Y-WHITE-YELLOW
 O-ORANGE W-WHITE W-O-WHITE-ORANGE
3. COMPONENTS SHOWN DOTTED ARE ACCESSORIES TO CABINET.
4. CABINET POWER CIRCUIT WIRED FOR 115V 50-60-AC OPERATION ONLY.
5. CONNECTORS VIEWED FROM SOLDER TERMINAL END.
6. SHIELDING STRAP OF SELECTOR CABLE.

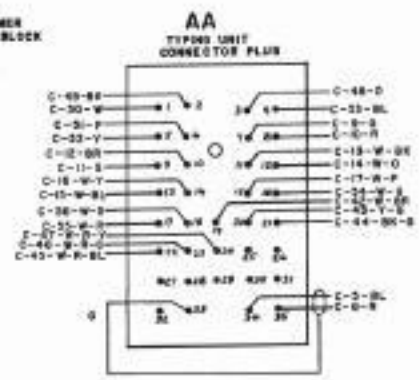
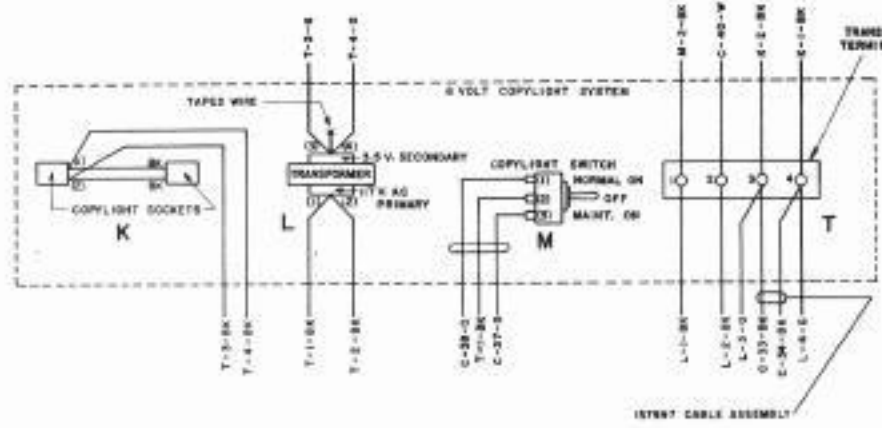
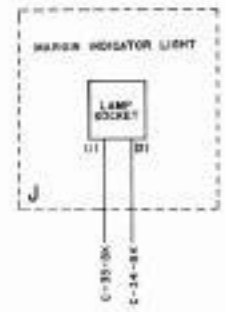
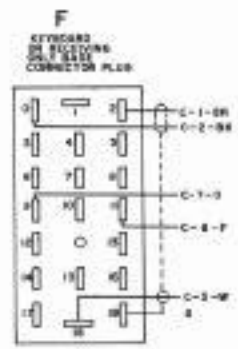
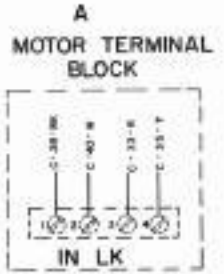
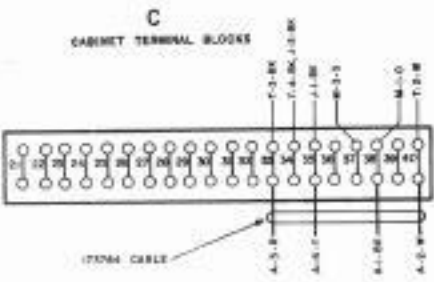
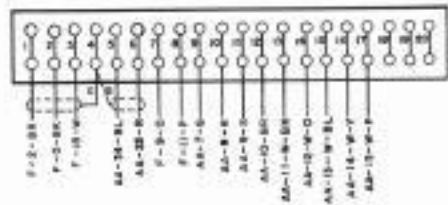

APPROVALS

DESIGNED BY: [Signature] E OF M

DATE: 9-1-60

PROJ. NO: 4268 WD

ACTUAL WIRING DIAGRAM FOR MODEL 28 PAGE PRINTER CABINET.

LAC 204, 246 ARRANGED FOR A.C. APPLICATION ACC. GRAPHS 555

DATE: 9-1-60
 PG. FILE NO. 15-A-65-03A
 DRAWN: A.S. CHASE: J.S.
 ENGR: V.A. C. APPS: [Signature]

TELETYPE CORPORATION

5 4268WD