

**BELL SYSTEM PRACTICES**  
**Teletypewriter and Data Stations**

**SECTION P34.351**  
**Issue 2, January, 1962**  
**AT&T Co Standard**

**28LC AND 28LC-1**  
**ELECTRICAL SERVICE UNITS**  
**WIRING DIAGRAM**

**1. GENERAL**

1.01 This section shows the wiring for the 28LC electrical service unit which mounts in a 28LB teletypewriter cabinet and the 28LC-1 electrical service unit which mounts in a 28LA apparatus cabinet.

1.02 This section is reissued to reverse the leads from the power plug to terminals 39 and 40 of the C terminal block on the cabinet.

28LC AND 28LC-1  
ELECTRICAL  
SERVICE  
UNITS  
WIRING  
DIAGRAM  
**P34.351**  
Page 1

**NOTES:**

**1. THE CABLES USED ARE THE FOLLOWING:**

CABLE ASSEMBLY	W/LAC 215	W/LBAC 227
F	145282	145064
R	145283	145062
S	145284	145063

2. AUDIBLE ALARM TO BE FURNISHED BY CUSTOMER.
3. SWITCH Q MUST BE IN "OFF" POSITION WHEN LESU IS INSTALLED IN 28 LA APP CAB.
4. TO CONNECT AUXILIARY PRINTER OR REPERFORATOR WITH LINE RELAY.
  - A. REMOVE STRAP CONNECTING AN-1 TO AN-2.
  - B. CONNECT + LINE SIDE OF LINE RELAY COIL TO AN-1 OR C-31.
  - C. CONNECT - LINE SIDE OF LINE RELAY COIL TO AN-2 OR C-32.
  - D. TO RECEIVE ON AUXILIARY UNIT ONLY AFTER CONFIRMATION HAS BEEN RECEIVED BY THE RECEIVING SET, CONNECT DC-4 AND DC-5 OR C-33 AND C-34 ACROSS THE AUXILIARY LINE RELAY CONTACTS.
  - E. AUXILIARY LOOP BATTERY, BIAS WINDING, MOUNTING FACILITIES, ETC MUST BE PROVIDED BY THE CUSTOMER AND ARE NOT SHOWN.
5. CIRCUITS SHOWN FOR .060 AMP NEUTRAL SIGNAL LINE OPERATION. FOR .020 AMP OPERATION REMOVE CONNECTION BETWEEN TERMINALS 1 AND 2 AND ADD CONNECTION BETWEEN TERMINALS 3 AND 4 ON THE LINE RELAY TERMINAL BLOCK.

**28LC and 28LC-1 Electrical Service Units**

28LC AND 28LC-1  
ELECTRICAL  
SERVICE  
UNITS  
WIRING  
DIAGRAM  
**P34.351**  
Page 3  
3 Pages

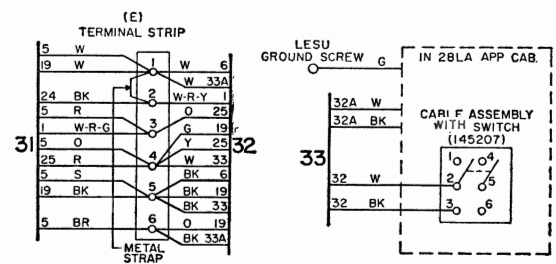
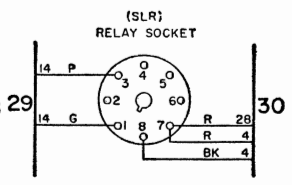
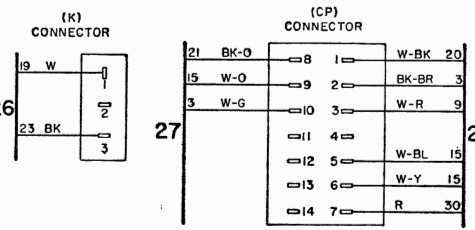
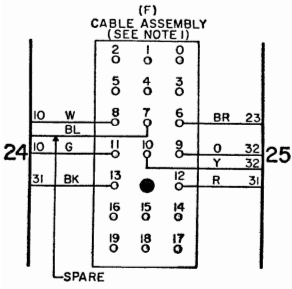
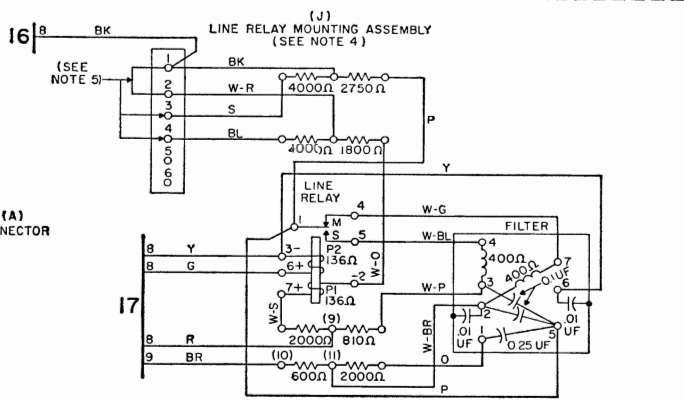
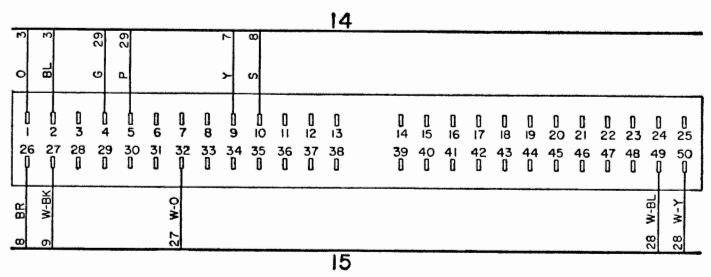
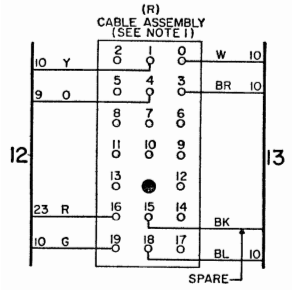
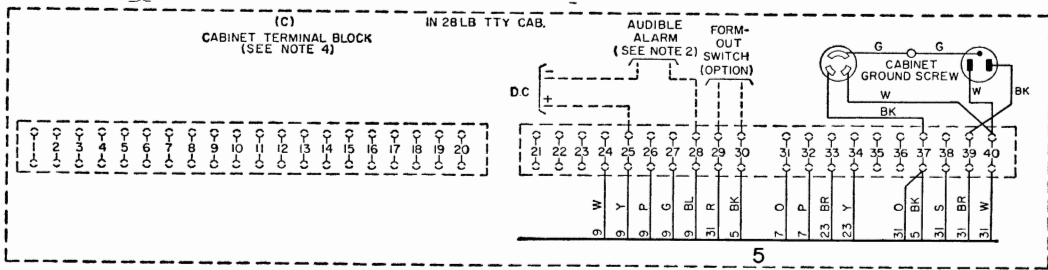
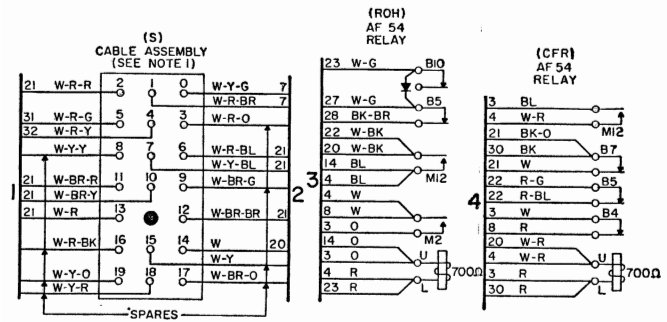

28LC and 28LC-1 Electrical Service Units

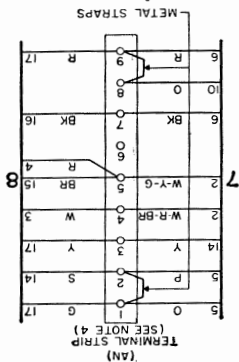
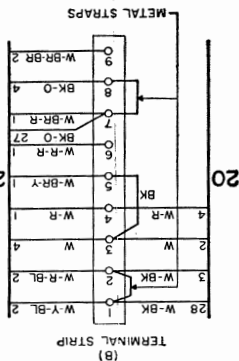
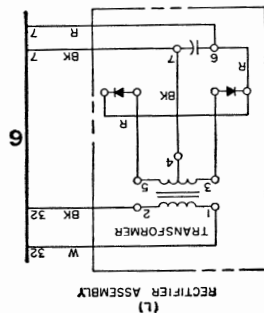
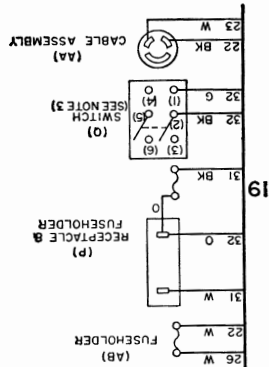

SERVICE  
UNITS  
WIRING  
DIAGRAM

P34.351

Page 1

