



Radioman Training Series

Module 2—Computer Systems

Only one answer sheet is included in the NRTC. Reproduce the required number of sheets you need or get answer sheets from your ESO or designated officer.

DISTRIBUTION STATEMENT A: Approved for public release; distribution is unlimited.

The public may request copies of this document by following the purchasing instruction on the inside cover.



0502LP0128710

Although the words “he,” “him,” and “his” are used sparingly in this manual to enhance communication, they are not intended to be gender driven nor to affront or discriminate against anyone reading this text.

DISTRIBUTION STATEMENT A: Approved for public release; distribution is unlimited.

The public may request copies of this document by writing to Superintendent of Documents, Government Printing Office, Washington, DC 20402-0001 or to the Naval Inventory Control Point (NAVICP) - Cog “P” Material, Attention Cash Sales, 700 Robbins Avenue, Philadelphia, PA 19111-5098.



RADIOMAN TRAINING SERIES

MODULE 2—COMPUTER SYSTEMS

NAVEDTRA 12846

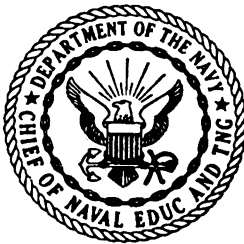

*1997 Edition Prepared by
DPC(SW) Walter Shugar, Jr. and
RMCS(SW/AW) Deborah Hearn*

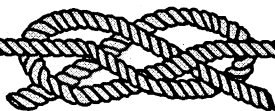

PREFACE

This training manual (TRAMAN), together with its nonresident training course (NRTC), NAVEDTRA 12846, form a self-study training package for personnel fulfilling the requirements of the Radioman rating. The TRAMAN provides subject matter that relates to the occupational standards for the RM rating. The NRTC consists of several assignments to help the student complete the TRAMAN.

This edition includes information on computer hardware startup, computer center operations, and data management.

This training manual was prepared by the Naval Education and Training Professional Development and Technology Center, Pensacola, Florida, for the Chief of Naval Education and Training.

1997 Edition

**Stock Ordering No.
0502-LP-012-8710**

Published by
NAVAL EDUCATION AND TRAINING PROFESSIONAL
DEVELOPMENT AND TECHNOLOGY CENTER

UNITED STATES
GOVERNMENT PRINTING OFFICE
WASHINGTON, D.C.: 1997

THE UNITED STATES NAVY

GUARDIAN OF OUR COUNTRY

The United States Navy is responsible for maintaining control of the sea and is a ready force on watch at home and overseas, capable of strong action to preserve the peace or of instant offensive action to win in war.

It is upon the maintenance of this control that our country's glorious future depends; the United States Navy exists to make it so.

WE SERVE WITH HONOR

Tradition, valor, and victory are the Navy's heritage from the past. To these may be added dedication, discipline, and vigilance as the watchwords of the present and the future.

At home or on distant stations as we serve with pride, confident in the respect of our country, our shipmates, and our families.

Our responsibilities sober us; our adversities strengthen us.

Service to God and Country is our special privilege. We serve with honor.

THE FUTURE OF THE NAVY

The Navy will always employ new weapons, new techniques, and greater power to protect and defend the United States on the sea, under the sea, and in the air.

Now and in the future, control of the sea gives the United States her greatest advantage for the maintenance of peace and for victory in war.

Mobility, surprise, dispersal, and offensive power are the keynotes of the new Navy. The roots of the Navy lie in a strong belief in the future, in continued dedication to our tasks, and in reflection on our heritage from the past.

Never have our opportunities and our responsibilities been greater.

CONTENTS

CHAPTER	PAGE
1. Computer Hardware Startup1-1
2. Computer Center Operations.	2-1
3. Data Management3-1
APPENDIX	
I. Glossary	AI-1
II. Glossary of Acronyms and Abbreviations	AII-1
III. References Used to Develop the TRAMAN	AIII-1
INDEX	INDEX-1

NONRESIDENT TRAINING COURSE follows the index

CREDITS

Trademark Credits

Microsoft is a registered trademark of Microsoft Corporation.

WordPerfect is a registered trademark of WordPerfect Corporation.

SUMMARY OF THE RADIOMAN TRAINING SERIES

MODULE 1

Administration and Security—This module covers Radioman duties relating to administering AIS and communication systems. Procedures and guidance for handling of classified information, messages, COMSEC material and equipment, and AIS requirements are discussed.

MODULE 2

Computer Systems—This module covers computer hardware startup, including peripheral operations and system modification. Other topics discussed include computer center operations, media library functions, system operations, and troubleshooting techniques. Data file processes, memory requirements, and database management are also covered.

MODULE 3

Network Communications—This module covers network administration, LAN hardware, and network troubleshooting. Related areas discussed are network configuration and operations, components and connections, and communication lines and nodes.

MODULE 4

Communications Hardware—This module covers various types of communications equipment, including satellites and antennas. Subjects discussed include hardware setup procedures, COMSEC equipment requirements, distress communications equipment, troubleshooting equipment, satellite theory, and antenna selection and positioning.

MODULE 5

Communications Center Operations—This module covers center operations, including transmit message systems, voice communications, center administration, quality control, and circuit setup/restorations. Guidelines for setting EMCON and HERO conditions and cryptosecurity requirements are also discussed.

CHAPTER 1

COMPUTER HARDWARE STARTUP

LEARNING OBJECTIVES

Upon completing this chapter, you should be able to do the following:

- *Describe the different components of a computer system.*
 - *Describe how to startup a computer system.*
 - *Describe how to set parameters for operation and how to perform and interpret diagnostic tests.*
 - *Explain what is involved in inspecting components, running system checks and troubleshooting error conditions.*
 - *Explain how to perform computer interface changes, CMOS changes and configuration changes.*
 - *Describe how to inspect, repair and install cables.*
 - *Explain how to install computer equipment and prepare computers for shipment.*
-

We receive information in many different forms, from our eyes, ears, nose, mouth, and even sensory nerves. Our brains receive and accept this information, work with it in some form or fashion, and then store it away somewhere in the back of our minds (memories) for future use. If what we are processing at the time requires immediate attention, our minds direct us to respond with words or actions. The computer's brain (the central processing unit) is designed to do basically the same thing. That is, it receives information (input data), works with this information (processes data), and transmits this information (output data) to some form of output media. This is often shown graphically as:

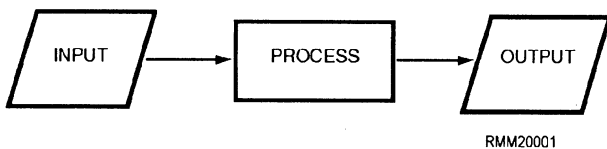

Computers do nothing more than what we instruct them to do. They simply follow a set of internally stored instructions (called a *program* or *software*) we provide and process the data we feed into them.

The design of fifth-generation computers is such that they will actually learn from previous experiences and apply what they have learned. This is called *artificial intelligence*. Artificial intelligence computers manipulate data more efficiently, with parallel processing, and understand written and spoken human language. Ultimately, we may have a computer similar to the human brain.

COMPUTER SYSTEM HARDWARE

All electronic digital computer systems consist of a central processing unit (CPU) and one or more peripheral devices for inputting and outputting data and

programs. Figure 1-1 shows the CPU and the types of peripheral (input and output [I/O]) devices you will find in a computer system. The devices are interconnected by electrical cables thru a bus to allow communications between them. The CPU communicates with the peripheral devices through input/output (I/O) channels.

The brain of a computer system is the central processing unit, which we refer to as the *CPU*. **THE CPU IS THE COMPUTER.** It receives the data transferred to it from one of the various I/O devices. It

processes the data and transfers the intermediate or final results to an I/O device for storage or distribution.

The CPU executes stored programs and does all the processing and manipulating of data. It contains the circuits that control and perform the execution of instructions using various types of memories. The I/O devices simply aid the computer by providing and receiving data and programs.

In this section, you'll learn about the control unit, the arithmetic-logic unit, primary storage, secondary storage, peripheral devices, I/O channels, and modems.

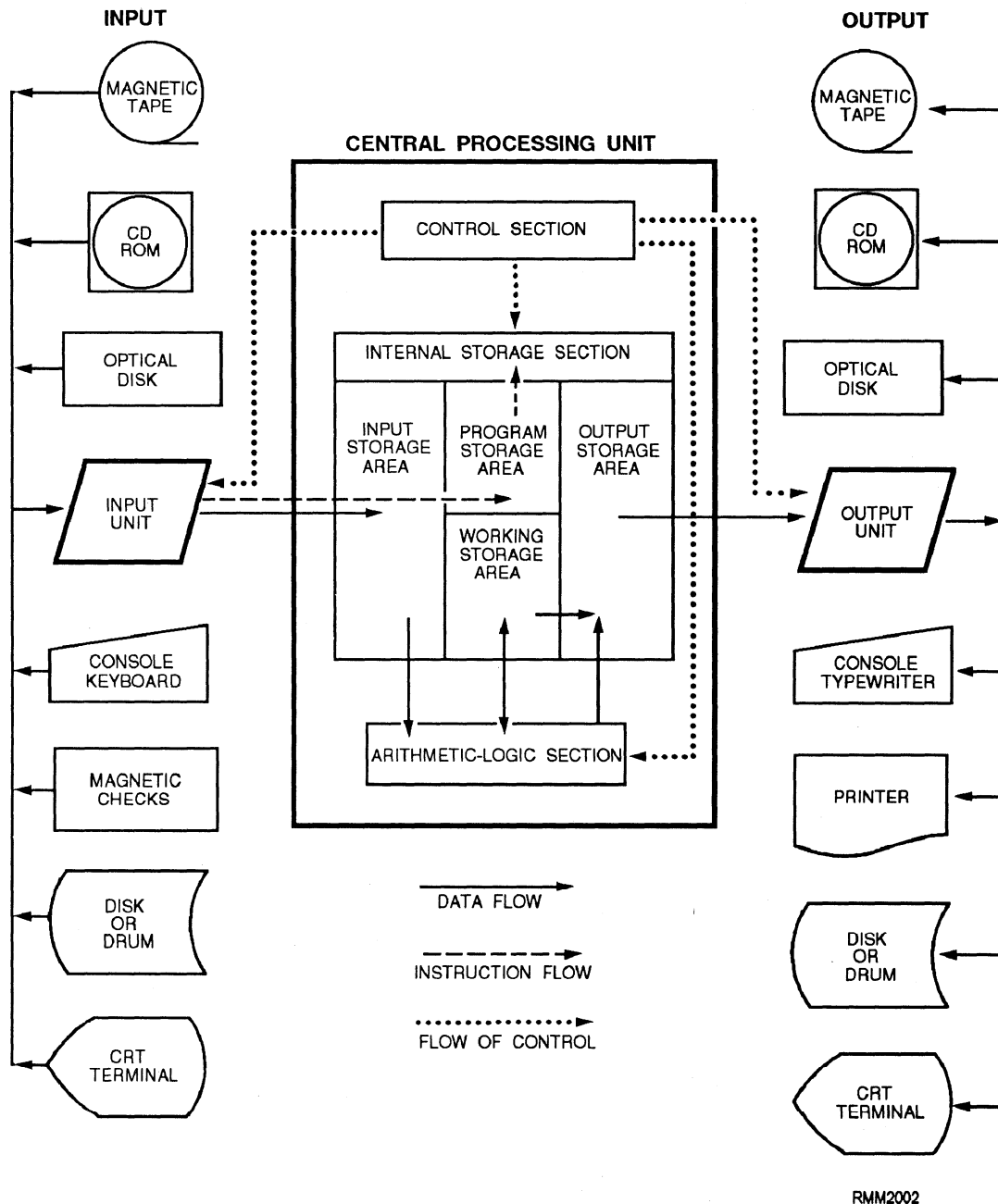

Figure 1-1.—Units/devices of a computer system.

CONTROL UNIT

The control unit maintains order within the computer system and directs the flow of traffic (operations) and data. The flow of control is indicated by the dotted arrows on figure 1-1. The control unit selects one program statement at a time from the program storage area, interprets the statement, and sends the appropriate electronic impulses to the arithmetic-logic unit and storage section to cause them to carry out the instruction.

The control unit does not perform the actual processing operations on the data. Specifically, the control unit manages the operations of the CPU, be it a single-chip microprocessor or a full-size mainframe. Like a traffic director, it decides when to start and stop (control and timing), what to do (program instructions), where to keep information (memory), and with what devices to communicate (I/O). It controls the flow of all data entering and leaving the computer. It accomplishes this by communicating or interfacing with the arithmetic-logic unit, memory, and I/O areas. It provides the computer with the ability to function under program control. Depending on the design of the computer, the CPU can also have the capability to function under manual control through man/machine interfacing.

The control unit consists of several basic logically defined areas. These logically defined areas work closely with each other. **Timing** in a computer regulates the flow of signals that control the operation of the computer. The **instruction and control** portion makes up the decision-making and memory-type functions. **Addressing** is the process of locating the operand (specific information) for a given operation. An **interrupt** is a break in the normal flow of operation of a computer (e.g., CTRL + ALT + DEL). **Control memory** is a random-access memory (RAM) consisting of addressable storage registers. **Cache memory** is a small, high-speed RAM buffer located between the CPU and main memory; it can increase the speed of the PC. **Read-only memory (ROM)** are chips with a set of software instructions supplied by the manufacturer built into them that enables the computer to perform its I/O operations.

The control unit is also capable of shutting down the computer when the power supply detects abnormal conditions.

ARITHMETIC-LOGIC UNIT

The arithmetic-logic unit (ALU) performs all arithmetic operations (addition, subtraction, multiplication, and division) and logic operations. Logic operations test various conditions encountered during processing and allow for different actions to be taken based on the results. The data required to perform the arithmetic and logical functions are inputs from the designated CPU registers and operands.

The ALU relies on basic items to perform its operations. These include number systems, data routing circuits (adders/subtractors), timing, instructions, operands, and registers. Figure 1-2 shows a representative block diagram of an ALU of a microcomputer.

PRIMARY STORAGE (MAIN MEMORY)

The primary storage section (also called *internal storage, main storage, main memory, or just memory*) serves four purposes:

- To hold data transferred from an I/O device to the **input storage area**, where it remains until the computer is ready to process it. This is indicated by the solid arrow on figure 1-1.
- To hold both the data being processed and the intermediate results of the arithmetic-logic operations. This is a **working storage area** within the storage section. It is sometimes referred to as a *scratch pad* memory.
- To hold the processing results in an **output storage area** for transfer to an I/O device.

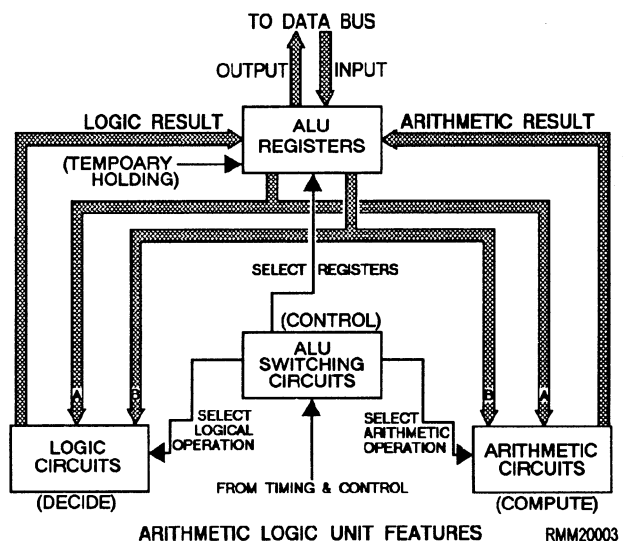

Figure 1-2.—Representative block diagram of an ALU.

- To hold the program statements transferred from an I/O device. This area is called the **program storage area**.

Please note that the four areas (input, working, output, and program storage) are **NOT** fixed in size or location, but rather are determined by each individual program's requirements.

About now, you're probably wondering how the control unit is able to find these stored instructions and data items. To understand this, picture memory as a wall of post office boxes in a post office. Each box has a different number (address) and represents a specific storage location in memory, as shown in figure 1-3. Like the mail in a post office box, the contents of a storage location can change, but the number on the post office box or memory address does not change. In this manner, a particular program instruction or data item that is held in primary storage can be located by knowing its address. It is the responsibility of the programmer to assign descriptive names to these data items. This enables the computer program and the computer to keep track of the storage location address of each data item.

Primary storage can be classified by its physical or functional characteristics.

Memory Types by Physical Characteristics

Primary storage devices may be classified according to the type of magnetic or electronic principle they use to store data. Some of the more common types are magnetic core storage, semiconductor storage, and bubble storage.

MAGNETIC CORE STORAGE.— Magnetic core storage, although not used as much as it used to be, provides an easy way to show the general concepts of memories, including integrated semiconductor and bubble types of memories. Magnetic core storage is made up of tiny doughnut-shaped rings made of ferrite

PRIMARY STORAGE				
1001	1002	39.29	1004	1005
1006	1007	86.48	1010	

RMM20004

Figure 1-3.—Memory locations.

(iron), which are strung on a grid of very thin wires. Because computers store data in binary form (covered in chapter 3), a two-state device is needed to represent the two binary digits (bits), 0 for OFF and 1 for ON. In core storage, each ferrite ring can represent a 0 bit or a 1 bit, depending on its magnetic state. If magnetized in one direction, it represents a 1 bit, and if magnetized in the opposite direction, it represents a 0 bit. These cores are magnetized by sending an electric current through the wires on which the core is strung. It is this direction of current that determines the state of each core. Look at figure 1-4. Since the cores store data in the form of magnetic charges, core storage retains the data even when the power is off. This is called *nonvolatile storage*. An example of nonvolatile storage is ROM. However, the process of reading from core is destructive. This means the data must be electronically regenerated after being read.

SEMICONDUCTOR STORAGE (SILICON CHIP).— Semiconductor memory has hundreds of thousands of tiny electronic circuits etched on a silicon chip. Each electronic circuit, called a *bit cell*, can represent a 0 bit or a 1 bit, depending on the current flow in that bit cell. An OFF state represents a 0 bit, and an ON state represents a 1 bit. Another name you'll hear used for semiconductor memory chips is *integrated circuits (ICs)*. (See figure 1-5.) Technological developments have enabled even more circuits to be put on a single chip, resulting in *large-scale integration (LSI)* and *very-large-scale integration (VLSI)*.

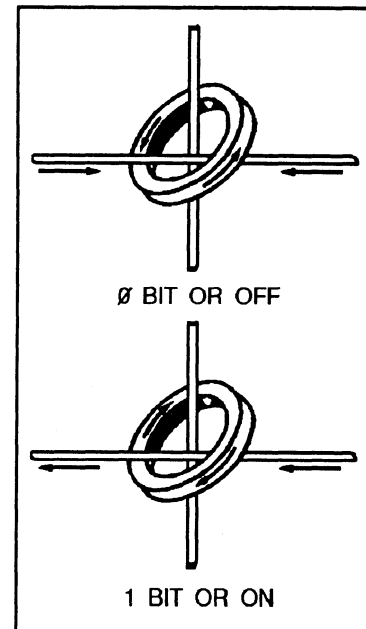

RMM20005

Figure 1-4.—Two-state principle of magnetic storage.

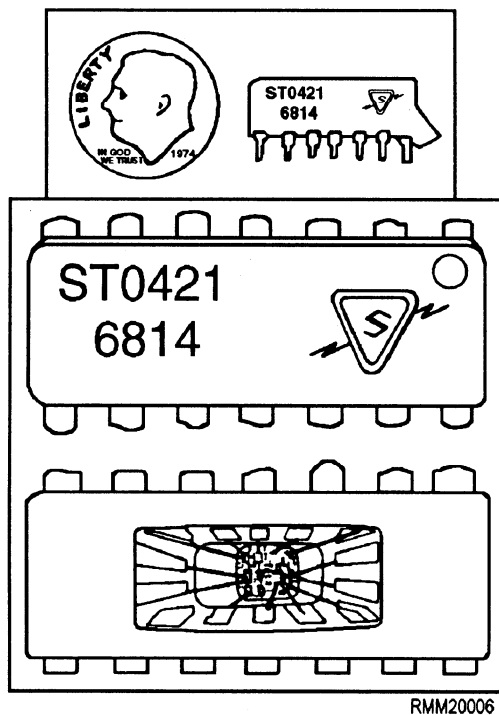

RMM20006

Figure 1-5.—Semiconductor memory chip exposed.

Some of the advantages of semiconductor storage are fast internal processing speeds, high reliability, low power consumption, high density (many circuits), and low cost. However, a drawback to this type of storage is that it must have a constant power source. The term for this is *volatile* storage. An example of volatile storage is

RAM. When you turn the power to the computer off, all the stored data is lost. Also, when there is a power failure and you do not have a backup power supply, all the stored data is lost. As mentioned, this is not the case with magnetic core storage. With core storage, the data is retained even when there is a power failure or breakdown, since data is stored in cores in the form of magnetic charges, not electric current.

BUBBLE STORAGE.— Bubble memory is one of the newer storage technologies, generally used in laptops. It consists of a very thin crystal made of semiconductor material. The molecules of the crystal act as tiny magnets. Data is stored by changing the polarity of these molecules, called *magnetic domains*. The magnetic domains can be switched in an opposite direction by passing a current through a control circuit imprinted on top of the crystal. Like magnetic core storage, bubble memory is nonvolatile. The data is retained even when the power is turned off or there is a power failure. Unlike magnetic storage, reading from bubble memory is nondestructive. The data does not have to be regenerated; it is still present after being read.

If we were to view these magnetic domains under a microscope, they would look like tiny bubbles; hence, the name, bubble memory. (See figure 1-6.)

Memory Types by Function

Functionally, we can classify memory by its operational features: random-access memory (RAM),

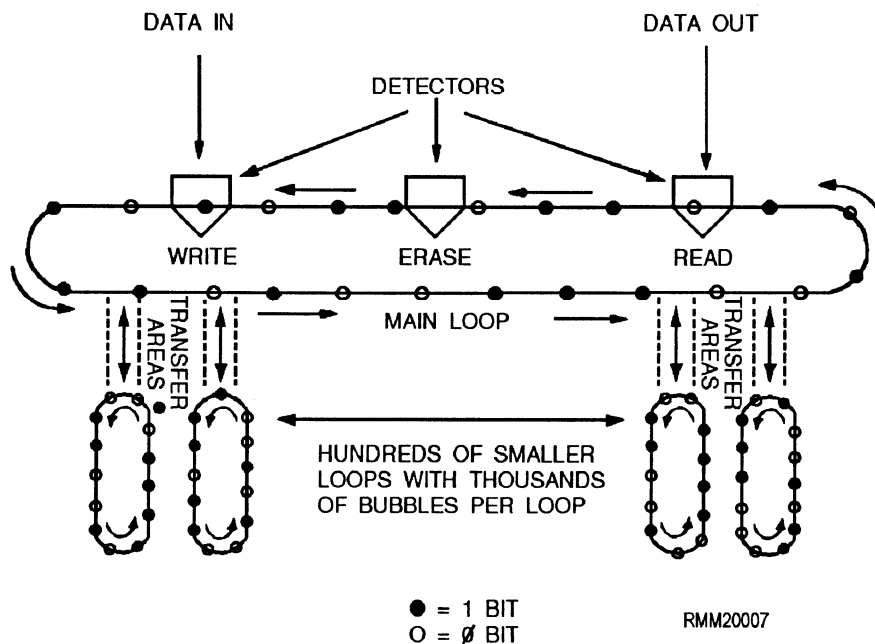

RMM20007

Figure 1-6.—Bubble memory.

read-only memory (ROM), programmable read-only memory (PROM), and erasable programmable read-only memory (EPROM).

RANDOM-ACCESS MEMORY (RAM).— RAM, also called *read/write memory*, is like a chalkboard. You can write notes, read them, and erase them when you no longer need them. In the computer, RAM is the working memory. Data can be read (retrieved) from or written (stored) into RAM just by giving the computer the address of the RAM location where the data is stored or is to be stored. When the data is no longer needed, you can simply write over it. This allows you to use the storage again for something else. Core, semiconductor, and bubble storage have random-access memory (RAM) capabilities.

READ-ONLY MEMORY (ROM).— In most computers, it is useful to have often used instructions, such as those used to bootstrap (initial system load) the computer or other specialized programs, permanently stored inside the computer. The memory that enables us to do this without the programs and data being lost even when the computer is powered down is read-only memory (ROM). Only the computer manufacturer can install these programs into ROM, and, once installed, they cannot be changed. Consequently, you cannot put any of your own data or programs into ROM. Many complex functions, such as routines to calculate square root, translators for high-level programming languages, and operating systems, can be stored into ROM. Because the instructions are permanently stored, they are quickly performed with accuracy. Also, your computer facility can order programs designed for its needs and have them permanently installed into ROM by the manufacturer. To describe these permanently installed programs, the term *microprogram*, or *firmware*, is used.

PROGRAMMABLE READ-ONLY MEMORY (PROM).— Your computer facility can also buy programmable read-only memory (PROM) already programmed by the manufacturer or in a blank state. Using a blank PROM and a device designed to write (burn) a program into PROM, you can enter any program into the memory. However, you cannot make any changes to the program once it has been written into PROM. But, PROM does provide flexibility not available with ROM. Of course, you must be sure the program is error free before it is written into PROM.

ERASABLE PROGRAMMABLE READ-ONLY MEMORY (EPROM).— The erasable programmable read-only memory (EPROM) was developed to overcome the drawback of PROM. Your facility can buy blank EPROMs from the manufacturer, and you can write programs developed at your command/activity using a special device. The big difference with EPROM is that you can erase it if and when the need arises. The data and programs can be retrieved many times. If you want to reprogram memory, you first erase the EPROM with a burst of ultraviolet light. This not only enables you to reprogram when requirements change, but also, you can erase and write the program again if a mistake is made while programming the EPROM. In other words, a mistake is not fatal, as it is when using PROM. You have the flexibility to change programs to include improvements or modifications in the future.

SECONDARY STORAGE

The last type of memory we briefly introduce here is called *secondary storage* or *auxiliary storage*. This is memory outside the main body of the computer where we store programs and data for future use. When the computer is ready to use these programs and data, it reads them into primary storage. Secondary (auxiliary) storage media extends the storage capabilities of the computer. We need secondary storage for two reasons. First, because the computer's working memory (primary storage) is finite and limited in size, it cannot always hold all the data we need. Second, in secondary storage, data and programs do not disappear when power is turned off as they do when semiconductor memories are used. Secondary storage media are nonvolatile memories. This means the information is lost only if you or the users intentionally erase it. The three types of secondary storage we most commonly use are magnetic tape, magnetic disk/diskette, and magnetic drum.

PERIPHERAL DEVICES

Peripheral devices include all the I/O devices used with a computer system. When these devices are under control of the CPU, we say they are *online*. When they perform their functions independently, not under direct control of the CPU, we say they are *offline*. The peripheral devices described in the following paragraphs are the ones we commonly use: magnetic ink character readers, scanners, bar-code readers, key-to-online data entry terminals, magnetic tape units, magnetic disk drive units, floppy disk drive units,

cathode-ray tube (CRT) terminals, printers, and plotters.

Magnetic Ink Character Readers

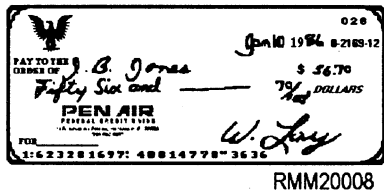

Magnetic ink character readers read magnetically inscribed information (like on a bank check) and translate it to machine code.

Scanners

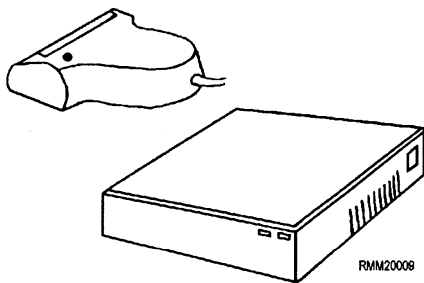

Scanners read text, drawings, and photographs and convert them into electronic representations of the images.

Bar-Code Readers



Bar-code readers scan data encoded in special bar codes using reflective light and translate them to machine code. Examples are the code on the front of this manual and the codes on supermarket and department store products.

Key-to-Online Data Entry Terminals

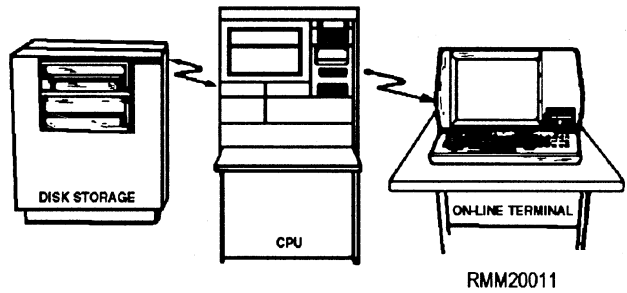

Using a key-to-online data entry terminal, a person enters input data into the computer directly from the point of origin. This eliminates the need for human intervention between source recording and the ultimate processing by the computer.

Magnetic Tape Units

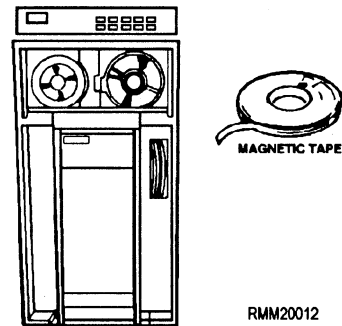

Magnetic tape units move magnetic tape across read/write heads that read and write the information. Characters are recorded (written) on the tape in the form of magnetized spots along the entire length of the tape. On tape, data is stored in a sequential manner. In sequential processing, the CPU must begin searching at the beginning of the tape and check each record until the desired data is found.

Magnetic Disk Drive Units

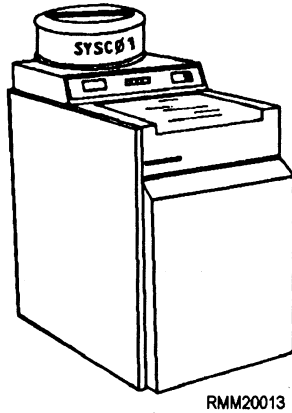

Magnetic disk drive units are storage devices that read and write information on the magnetized surfaces of rotating disks. The disks are made of thin metal, coated on each side so that data can be recorded in the form of magnetized spots. As the disks spin, characters can be stored on them or retrieved from them in a random (direct) manner. This direct accessing of data has a big advantage over the sequential accessing of data. You can direct the disk drive to begin reading at any point.

Floppy Disk Drive Units

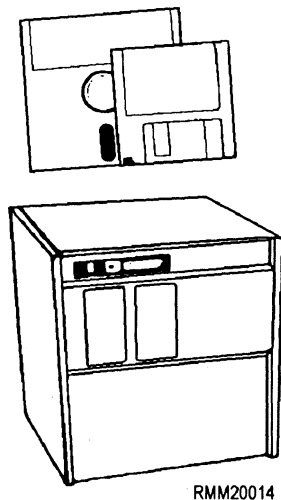

Floppy disk drive units consist of a diskette drive (the mechanism within which the diskette rotates) and a controller containing the electronic circuitry that feeds signals into and from the diskette. Diskettes are thin, flexible platters (floppy disks) coated with magnetic material so characters can be recorded on the surface in the form of magnetized spots. Just like hard disks, as the disk spins, characters can be stored on them or retrieved from them in a random (direct) manner.

Computer Consoles

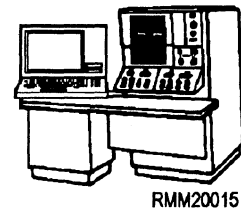

Computer consoles usually include at least a display and a keyboard. They may also include a printer. The main console is located near the CPU and is used by the computer operator to control the operations of the computer system. Other consoles may be used at the peripheral devices to specify what media to mount, what forms to use in the printer, what alignment is required, and so on. They may also be used by the peripheral equipment operator to start and stop jobs, bring up other peripheral devices, requeue jobs, and so on. Computer consoles are not normally used for keying data from source documents for production jobs.

Cathode-Ray Tube (CRT) Terminals

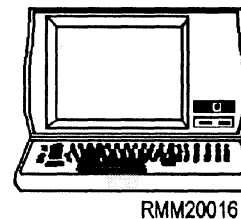

A cathode-ray tube (CRT) terminal looks like a television with a typewriter-like keyboard. It allows you, the operator, to enter programs and data directly to the computer. At the same time, it displays the program or data on the display screen of the CRT. It can also receive information directly from the computer and display it on the screen. You can add a printer, a modem, and adapters to the CRT terminal to provide for printed output and communications through telephone lines.

Printers

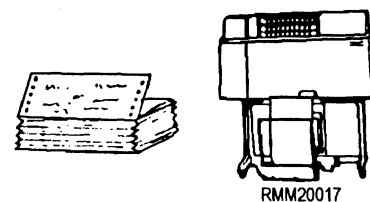

Printers are widely used output devices that express coded characters as hard (paper document) copy. They print computer results as numbers, letters, words,

symbols, graphics, or drawings. Printers range from electric typewriters to high-speed printers. Low-speed line printers include the dot-matrix printer commonly used with personal computers. High-speed line printers are normally used with larger computers to print supply requisitions, paychecks, inventory, or financial reports at 10 lines per second and faster. Laser printers provide high quality print and print a full page at one time. They are used with all types of computers.

Plotters

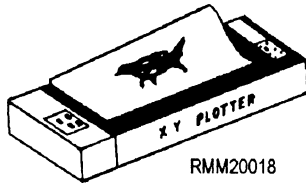

Plotters are used with a computer to plot coordinate points in the form of a graph. Digital incremental plotters, in either online or offline operation with a digital computer, provide a high-speed plotting system of high versatility and reliability. For online operation, a small adapter unit converts the computer output signals to a form suitable for driving the plotter.

INPUT/OUTPUT (I/O) CHANNELS

The input/output (I/O) channels provide for communications between the CPU and all peripheral devices. This is accomplished by electrical cables that carry both data and control information to and from the computer and peripheral devices.

Signals are transmitted and received through a cable connecting the CPU and its online devices. This cable or line provides a path for the signal to travel and is called a *channel*. Not only signals for monitoring but also data are transmitted via channels. All channels between the CPU and the peripheral devices are designated as I/O channels. An I/O channel may be used for data input, data output, or data input and output, depending on whether the peripheral device handles input only, output only, or both input and output.

Channel Types

I/O channels may be simplex or duplex.

SIMPLEX CHANNELS.— In simplex operations, communications are in one direction only, such as a radio. If a device such as a terminal were to be connected to such a circuit, it would only be capable of sending or receiving data, but not both. For this reason,

simplex circuits are seldom used, because a return path is generally needed to send acknowledgment, control information, or some type of error signals.

DUPLEX CHANNELS.— A duplex channel simply means that within each cable connection, there are two paths (lines) for the transmission of data. One path is for sending, and one is for receiving, similar to your telephone. There are two types of duplex channels, half-duplex, and full-duplex. A **half-duplex channel** is capable of transmitting and receiving signals, but only in one direction at a time, similar to citizens' band (CB) radio transmissions. Therefore, it is necessary to check that the line is clear (idle) before starting a transmission. A **full-duplex channel** provides for simultaneous transmission in both directions, as in the use of the telephone.

Data Transmission Methods

Data may be transmitted over a channel in one of two ways, in either serial mode or parallel mode.

SERIAL MODE.— In serial transmission, basically only three wires are needed: one to transmit data, one to receive data, and one to ground. The data is sent or received in the form of bits, one after another in serial fashion, as shown in figure 1-7. This type of transmission is highly desirable whenever the computer system is linked to outside peripherals over a long distance, such as remote terminals.

PARALLEL MODE.— Parallel transmission is a little more difficult to hookup than serial. It requires all the data bits in a byte to be transmitted at one time (batch mode); so you usually have nine or ten wires going between the computer and the peripheral devices. You have seven or eight lines for the data bits (figure 1-7) that make up a letter, number, or special character; one line to ground; and one or two lines called *handshake* lines. The handshaking signals communicate information back and forth between the peripheral device and the computer. This information lets the

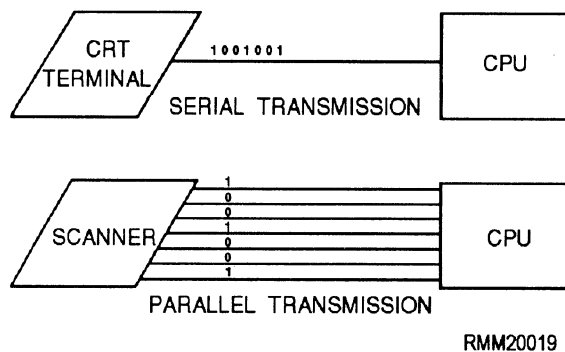

Figure 1-7.—Serial and parallel data transmission.

peripheral device know when the computer is ready to accept another character and vice versa. This type of transmission is used when you want to have fast data transfer. Its drawback is that the computer cannot be too far away from the peripheral device.

MODEMS

We said that both signals and data can be transmitted and received through cables (communications lines), which we refer to as I/O channels. When we transmit data directly to the computer over long distances, it becomes necessary to add two other devices, one at each end of the communications line. These devices are called *modems*. The word *modem* is an acronym for MODulator-DEModulator. A modem converts the digital signal produced by your terminal (or the computer) to an audio signal suitable for transmission over the communications line. The modem at the other end of the line reconverts the audio signal back to a digital signal before it is supplied to the computer (or your terminal). If this conversion were not carried out, the digital signal would degenerate and become garbled during transmission.

WORKING WITH MICROCOMPUTERS

Microcomputers are everywhere. They stand alone. They communicate with minis and mainframes. They communicate with other micros through local-area networks. This communication is accomplished by the use of software designed to make your computer system function. The operating system software enables you to install, select, and execute a variety of programs. It does this through system/job control languages and/or commands.

Microcomputer users are not often computer specialists. They are end users in the functional areas doing computer processing specific to their requirements. They need to know about the software: the operating system, the communication software, and the applications programs. They need to know about the hardware: the microcomputer, the hard disks and the floppies, the monitor, the keyboard, and the printer. You will need to help them configure (set up) the system, install the operating system and/or applications program, and troubleshoot problems.

You need to know more than just merely how to operate them if you are to become a **communications specialist**. To be effective, you must keep up with the latest changes in microcomputer technology and terminology. You must have a good working knowledge of microcomputer hardware components

(the computer, peripherals, and accessories). You should also be able to explain and demonstrate how to use the different types of systems and applications software to both computer and noncomputer personnel. Last, but not least, you should know how to use the various types of documentation supplied by the manufacturer and software vendors.

As a communications specialist, you must be able to set up, configure, upgrade, and initialize microcomputer systems. You will need to know how to install applications software so it works with the system's unique configuration. It will be your job to help noncomputer users, end users, learn and understand everything they need to know to work in a microcomputer environment. This includes how to interconnect various peripheral devices (keyboard, monitor, printer) to the computer or system unit. It also includes how to tailor the software for the operating system and the applications software to each user's unique hardware configuration. You need to teach them how to format and label diskettes; how to properly manage, back up, clean up, and store their files. You need to demonstrate routine operator maintenance and explain security procedures. When users are having problems with their micros, you may be called upon to troubleshoot the systems using system diagnostics to help isolate and determine whether the problem is hardware or software related. You will also be expected to make recommendations and/or arrangements to have repairs made. There will be times when you will be expected to make repairs if spare parts are available.

On microcomputers, you will need to be familiar with all types of productivity software—the program packages (or packaged software). These include word processing, spreadsheet, and database programs at a minimum. You also need to learn how to use local-area network software, communications programs, graphics programs, computer-aided design (CAD) programs, desktop publishing programs, and so on. You, as a professional data processor, may also be involved with the construction and modification of batch files. This provides a convenient way to save numerous keystrokes for the user and allow the computer to run unattended for some periods of time. All of these software functions can and have been implemented on both large and small scale computers.

On large computer systems, you maybe executing programs through system/job control language commands and processing jobs with multi-reel tape files or files that reside on disk packs. You will be responsible for ensuring that system control commands

are correct for a job, selecting a utility program to copy a file or create a new file by specifying the parameters, and working with an online database management system that keeps up-to-date information on inventory management or personnel.

In looking over these last few paragraphs, possibly you see yourself as a worker, a supervisor, a teacher, and a troubleshooter, and rightly so. Microcomputers make up a significant part of your profession; and because of this, you will be the person that others will come to looking for answers to their questions. The mere fact that you are a communications specialist gives the outside world, the end users, the impression you know it all; that is, all there is to know about mainframes, minis, and particularly microcomputers.

WORKING WITH HARDWARE

Microcomputers come in many shapes and sizes with a variety of capabilities. A microcomputer can be designed to operate in a **stand-alone** configuration or as a component, an intelligent terminal, a server for a complex **local-area network (LAN)** or large **distributed system**. In this chapter, we will focus our attention on desktop microcomputers that operate in a stand-alone environment. Most stand-alone, desktop microcomputer systems contain at least five hardware components. They are as follows:

- The computer or system unit, which normally houses the microcomputer (microprocessor chip[s]) along with other hardware components and secondary storage devices;
- Secondary storage devices (floppy disk drives, hard disk drives, and magnetic tape units), housed either in the system unit or separately;
- A monitor (standard output device);
- A keyboard (standard input device); and
- A printer (an additional output device—for hard copy).

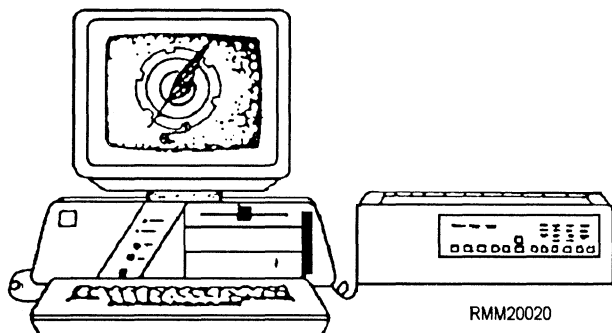

THE MICROCOMPUTER

In this section, we will examine the microcomputer with its individual hardware components. We will examine it from the inside. You will see how the components work and how they interface and interconnect with one another.

There will come a time when you may be required to replace or add a board in a computer to upgrade or expand the capabilities of the system. A few examples are as follows:

- You may need to install an expanded memory board to increase the amount of RAM to accommodate larger applications.
- You may have to replace the enhanced graphics adapter (EGA) board with an video graphics array (VGA) board to upgrade the graphics capabilities of your system.
- You may need to install a communications board.

You may receive a new software release that requires the presence (or absence) of certain boards to function properly. You do not want to find out too late that your software is incompatible with your hardware. You might have to answer questions such as the following: Will the graphics software the user wants to order work with the graphics board currently installed in the system? Does the user's system have sufficient room to accommodate another hard disk drive? A diagnostics routine may indicate that the disk controller board needs to be replaced, and so on, and so on. For reasons such as these, you will need to know a lot more about microcomputers (both inside and out) if you are to be effective and able to help others in your work environment.

The Computer or System Unit

The computer or system unit is the main part or heart of the total microcomputer system. Inside this unit all data is processed, arithmetic and logic functions are performed, and control is maintained for the system. If you were to remove the outer cover from this unit (figure 1-8), you would see a power supply and as many

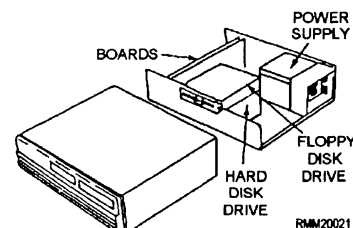

Figure 1-8.—A microcomputer system unit with the cover removed.

as two floppy disk drives and two hard disk drives or any combination thereof, depending upon the particular configuration of your system. You would also see several boards (also referred to as cards). Some boards are used to control the peripheral devices of the system, while other boards work in conjunction with the microprocessor that is located on the system or motherboard itself. These boards provide the flexibility to add a variety of capabilities to a basic system. Certain boards are required, such as the system board that contains the main microprocessor(s). Others you might add to control a light pen or mouse device, or to handle a communications interface.

Looking inside the computer system unit (figure 1-8), you will notice there are 5 available slots for board insertion. These various boards are plugged into what is called the **motherboard**. The motherboard is a printed circuit board that transmits the **power** and **electronic signals** between the other boards and peripheral devices. It is mounted to the bottom of the chassis of the computer, as shown in figure 1-9. Memory chips, on the newer micros, called single in-line memory modules (SIMMs), are located on the motherboard in a group of 4 or 8 slots. In older micros the memory chips are located on a memory expansion board. Most microcomputers also have a lithium battery installed on the motherboard. It provides power to the real-time clock when the system is turned off. The life expectancy of this battery is 3 to 5 years. Other boards you are likely to see in a typical microcomputer are the **disk controller board**, **SCSI adapter board**, and

video display board (figure 1-9). We will take a look at each.

SLOT A—SCSI ADAPTER BOARD.— The small computer systems interface (SCSI) adapter board is used to control peripheral equipment, such as a CD-ROM drive.

SLOTS B, D, E, F, AND H.— Slots B, D, E, F, and H on this particular micro are reserved for future use.

SLOT C—DISK CONTROLLER BOARD.— Most disk controller boards are capable of supporting two internal hard disk drives, two internal floppy drives, and one external magnetic tape drive for tape backup.

SLOT G-VIDEO DISPLAY BOARD.— The video display board includes graphics memory chips to provide the system with graphics capabilities. Most micros come from the factory set for VGA (video graphics array) settings.

By now, you should have a pretty good idea of what you can expect to see inside the system unit in the way of microcomputer boards. Before installing any internal components within the system unit, you must first **carefully** remove the outer cover. Be sure you are authorized to make such changes before removing the cover. However, before you go looking for a screwdriver, read the owner's manual very carefully, paying particular attention to the section on cover removal and the steps to follow. For example, the owner's manual might say: "Once all cabinet screws have been removed, raise the cover, keeping it as high as

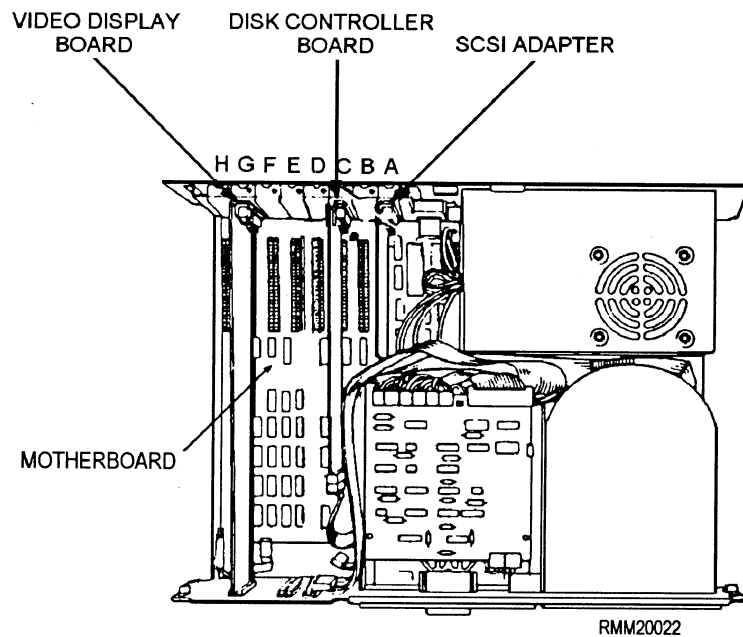

Figure 1-9.—Boards within the microcomputer system unit and their locations.

possible while pulling it forward for removal.” This action ensures that none of the internal wires, cables, or connectors are accidentally pulled loose and avoids possible damage to the components already installed inside the system unit.

So that you will have a better understanding and appreciation for this microcomputer, we will take a closer look at microprocessor chips and see how they differ from one another. We will also examine what all this means to you from a communications specialist’s standpoint.

Microprocessor Chips

All microcomputer systems are driven by one or more microprocessor chips. A microprocessor chip is made up of thousands of integrated circuits that contain all of the essential elements of a central processing unit (figure 1-10). These include the control logic, instruction decoding, and arithmetic-processing circuitry.

To be useful, the microprocessor chip (which is no bigger than your fingernail) must be mounted onto what is called a carrier package (figure 1-11). This carrier package along with other chips—memory chips (RAM and ROM) and I/O integrated circuit chips—are plugged into specific socket locations on a circuit board called the system board or the motherboard (figure 1-12).

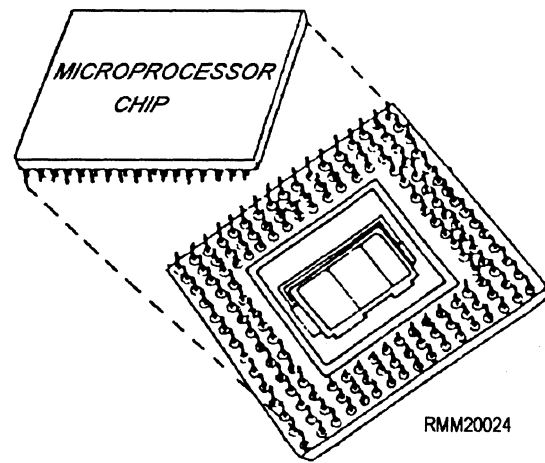

Figure 1-11.—A microprocessor being mounted onto the carrier package.

Of all the boards in the microcomputer, the system board is the most important. But what are the functions of the microprocessor chip? Are all microprocessor chips designed to perform the same functions? Basically, yes; but there are some significant differences in how they perform their functions. You should be aware of these differences, especially if you will be working with several different types of micros.

A chip, is a chip, is a chip, OR IS IT? Computer chips, like everything else in data processing, have some rather unique and unusual names; names like Zilog Z-80A, Intel 80C88, MOS Technology 6502, Motorola 68000, and so on. Some chip names contain letters and numbers. Others contain only numbers. Having the right microprocessor chip in your computer

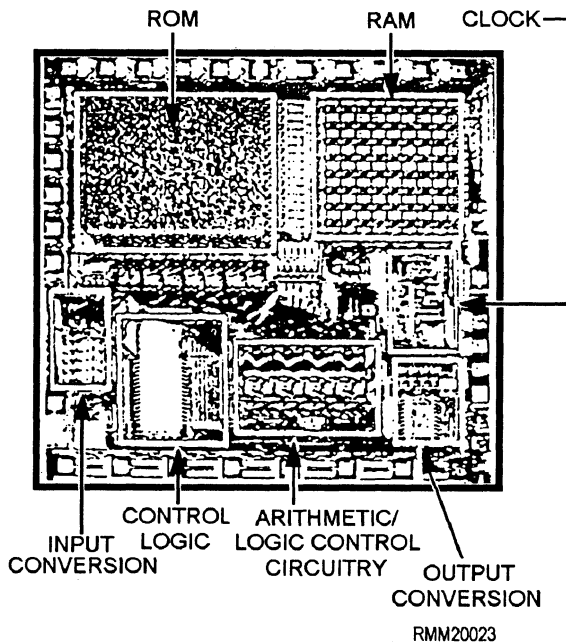

Figure 1-10.—A typical microprocessor computer chip.

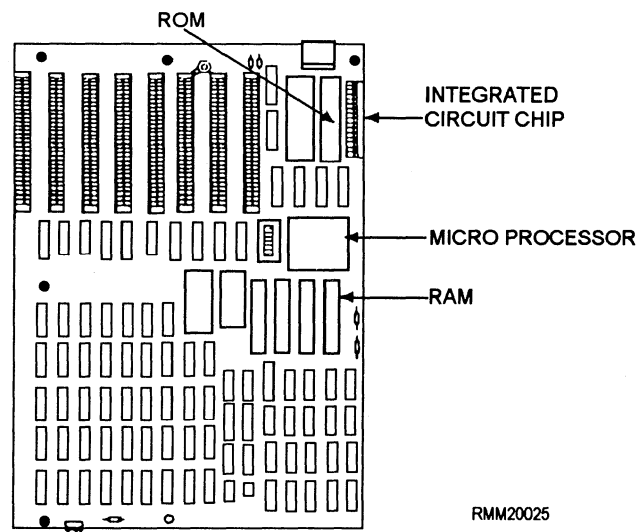

Figure 1-12.—The system/motherboard showing placement of the microprocessor, RAM, ROM, and integrated circuit chip.

system makes all the difference in the world in terms of **internal processing speeds** (33MHz, 66MHz, 120MHz, and so on), **number of bits handled** (8, 16, or 32 bits), **memory size** (640K, 4M, 16M, and up), and the **applications software** it will run.

Each microcomputer contains a specific microprocessor chip as its main processor. A microprocessor chip can typically handle 8, 16, or 32 bits of information at once. Generally speaking, the more bits a computer can manipulate at one time, the faster it can process program instructions and data, and the larger the main or primary memory it can accommodate. The type of chip in your computer or system unit also has a great effect on what you can do with your micro. For example, operating systems are written to serve a specific microprocessor chip, and applications programs that work under one operating system are not likely to work under another unless the program is modified. Many applications programs come in several versions to provide compatibility with several operating systems.

These are just a few of the reasons why we say it is very important that you read **all the documentation** that comes with your microcomputer. The Navy uses many different types of microcomputers and microprocessor chips. To give you an idea of the variety, table 1-1 lists some of the microprocessor chips.

Specialized Processors

Specialized processor chips have been developed to shift some of the workload from the main

Table 1-1.—Microcomputer Chips and Microcomputers

PROCESSOR	DATA BUS	DATE INTRODUCED
8088	8 bits	June 1979
8086	16 bits	June 1978
286	16 bits	February 1982
386SX	16 bits	June 1988
386SL	16 bits	October 1990
386SLC	16 bits	October 1991
386DX	32 bits	October 1985
486SX	32 bits	April 1991
486DX	32 bits	April 1989
Pentium	32 bits	March 1993

microprocessor chip. For example, IBM uses an Intel 8048 chip on the keyboard to determine which keys are being depressed and also to check to see that the keyboard is communicating properly with the microprocessor. In fact, most peripheral devices have one or more specialized processors embedded in them.

Other specialized processors are the Intel 80287 and the faster 80387 math coprocessor. These are special-purpose programmable microprocessors designed to perform arithmetic calculations up to 100 times faster than the main microprocessor. A math coprocessor executes arithmetic instructions that would normally be handled by the main microprocessor's arithmetic-logic unit (ALU) as well as those the main microprocessor cannot perform because of register constraints. The 80287 and 80387 are companion chips to the Intel family of microprocessors. Computer systems using the 80 series of chips are capable of very high-speed mathematical operations when the math coprocessor chip is plugged either into or alongside the system or motherboard. Math coprocessor chips are used in SX version computers. The SX denotes that the computer does not have a math coprocessor integrated into the cpu chip. A DX version computer has a math coprocessor integrated into the cpu chip. With the development of the Pentium chip, math coprocessor chips were no longer required to perform arithmetic calculations.

INPUT/OUTPUT DEVICES AND ACCESSORIES

To the system unit we must add input/output devices to communicate between us and the computer. These include the monitor, the keyboard, disk drives, and the printer. We will look at each of these devices in the following sections, along with some of the more common accessories found on microcomputers, such as surge protectors, parallel to serial converters and vice versa, null modems, cables, and switches used for sharing hardware.

Monitors (Display Devices)

Monitors are used as output devices on microcomputers. They are peripheral devices that contain a display like a television viewing screen. They are the principal link between you and the microcomputer. Their sole purpose in life is to allow the microcomputer to communicate its actions to you (the user), so you can act upon those actions to accomplish whatever job you are doing. They display output from the computer. The monitor is one of the most important peripherals to a micro and is certainly the most visible.

Quite often, the term *monitor* is used interchangeably with such names as screen, display, display device, and **cathode-ray tube (crt)**.

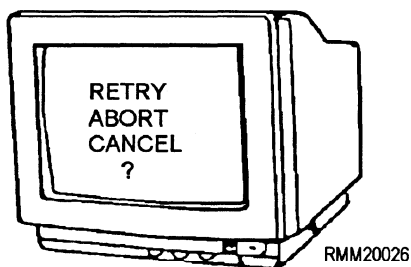

Monitors can display information in either monochrome or color, depending on their design. **Monochrome displays** produce output images using a single foreground color, such as black, and a single background color, such as white. This provides you with black text on a white background. Using a technique known as **reverse video** (that is, reversing the color of the pixels or dots on the screen), it is possible to have white text on a black background. Monochrome displays also come in amber (a yellowish brown) and green. Amber and green are considered more pleasing and less stressful to the eyes than black and white. Most **color displays** are of the red-green-blue (RGB) type. Depending upon the sophistication of the display device and the amount of RAM available with the microcomputer, you may be able to display from 8 to 16,000,000 colors.

Now, let's take a closer look and discuss some of the more common features you are likely to find on monitors. These include brightness, contrast, and sizing. We will also discuss the various types of video display and graphics boards/cards that are used to support them.

You use the brightness control to vary the brightness of displayed data. When adjusting this control, you turn the dial until the intensity is at the brightness level desired. Use the contrast control to vary the difference between the nonintensified colors and the intensified colors.

Monitors with a sizing feature allow you to increase or decrease the physical size (the height and width) of the displayed information on your screen. Some models use control knobs. Others use two-position switches. Depending on the type monitor you have, these control knobs or switches could be located just about anywhere; on the back, on the sides, or tucked away underneath the monitor to keep them from being accidentally hit, as shown in figure 1-13.

Located on the front of most monitors, generally below the screen, you will find some type of power on/off switch. It will probably have a green light-emitting diode (LED) indicator light. When this light is lit, the monitor is on and power is supplied.

At this point, it would be helpful for you to have a basic understanding of display technology, along with the various types of display/graphics cards used to support display devices. Having a good working knowledge in this area will put you in a better position to assist the end users in answering any technical questions they may have, as well as aid you in troubleshooting and diagnostics testing.

A key characteristic of any display device is its **resolution**, which determines the sharpness and clarity of the screen image. If you look closely at your display, you'll notice that images are formed by lighting up tiny dots on the screen. Resolution is measured by the number of these **dots** or **pixels** (short for picture elements) per square inch of screen. Whether you are working with text or graphic images, the more pixels used to form characters/images and the more pixels that can be packed per square inch of screen, the higher the resolution and the sharper the character/image. For example, a display resolution of 1280 by 1024 means that the screen consists of 1280 vertical columns by 1024 horizontal rows of dots, or if you prefer $1280 \times 1024 = 1,310,720$ pixels.

The distance between the dots is called **dot pitch**. Smaller pitch values indicate sharper images. The original IBM PC color monitor had a dot pitch of 0.43mm. The state-of-the-art displays marketed today have a dot pitch of 0.28mm or less.

Most display devices are capable of providing you with both text and graphics (pictures). Text output consists of letters, numbers, and special characters only. Text characters are created on the screen in the form of a

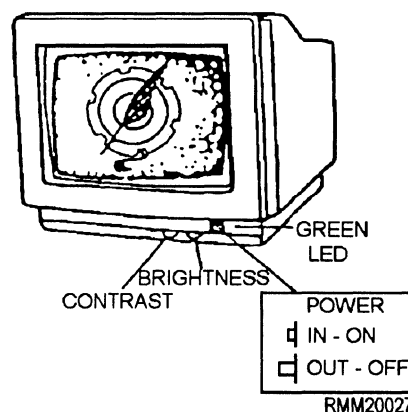
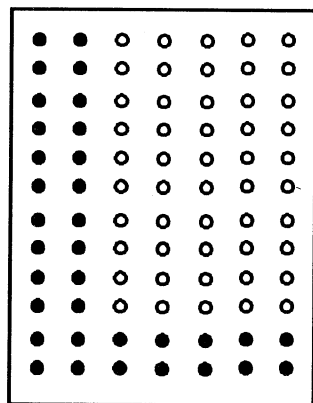

Figure 1-13.—Monitor controls, switches, and indicators.

dot-matrix similar to a dot-matrix printing device. Normally, it is the display device manufacturer who will decide on a specific matrix size—say, 7 by 12 (for a total of 84 dots or pixels) to display each character of text (see figure 1-14). The more pixels used to form characters, the higher is the resolution. Most display devices use 25 rows of 80-character lines when displaying text, and there are some that will display 50 rows of 132-character lines in what is called a compressed mode.

Graphics output consists of complex picture images, which brings us to the term **bit mapping**. Bit mapped graphics use a technique whereby each dot or pixel on the screen can be addressed and individually controlled by the user. This allows you to create virtually any type of image on the screen. Knowing this should give you a better understanding and appreciation of why resolution is so important, especially if you are viewing two documents on the screen at the same time, side-by-side, or working with three-dimensional graphics.

The type of monitor or display device you have on your microcomputer will often dictate what type of display/graphics board you can plug into your system unit. The key word here is **compatibility**. Some display devices can automatically switch between any standard display/color graphics card. Having such a display device or monitor allows you to upgrade the video/ graphics board in the system unit without having to upgrade the display unit. However, not all display devices are designed to accept the different types of video boards available primarily because of their resolution characteristics. It is important that you read **all the documentation** that comes with your micro to determine whether or NOT your display device will be compatible with the video/graphics board you want to install.



RMM20028

Figure 1-14.—The letter “L” as formed within a 7- by 12-dot matrix.

Keyboards

Of all the components that make up a microcomputer, you will become most familiar with the keyboard. It will probably be your primary means for inputting programs and data on microcomputers.

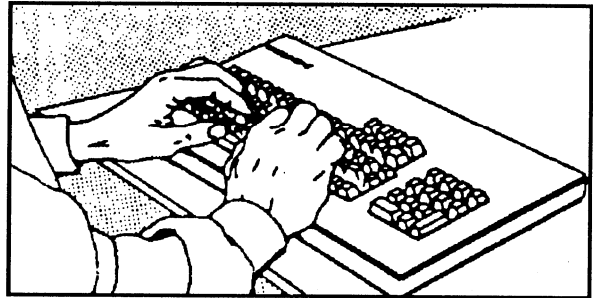

RMM20029

Keyboards come in many shapes and sizes, have different numbers and arrangements of keys, differ in respect to touch, and have special keys to allow you to communicate specific software commands. Most manufacturers have designed their keyboards as separate devices so you can place them wherever it is convenient. Other manufacturers have designed their keyboards into the display/monitor device or system unit.

The important things you need to know about keyboards are the types of keys and the function and placement of each. All keyboards have the alphabetic characters (upper and lower case), numbers, and some special characters. In addition, keyboards have special function keys and control keys that are defined by the operating system or the program. We will briefly describe an example keyboard and explain some of the more common keys you are likely to use.

LETTERS, NUMBERS, AND SPECIAL CHARACTER KEYS.—

The arrangement of letter, number, and special character keys may vary. The QWERTY keyboard shown in figure 1-15 has the same format as the conventional typewriter.

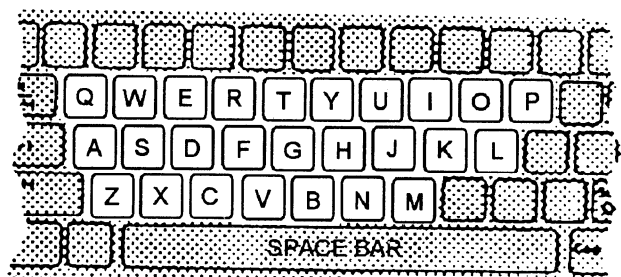

RMM20030

Figure 1-15.—QWERTY keyboard.

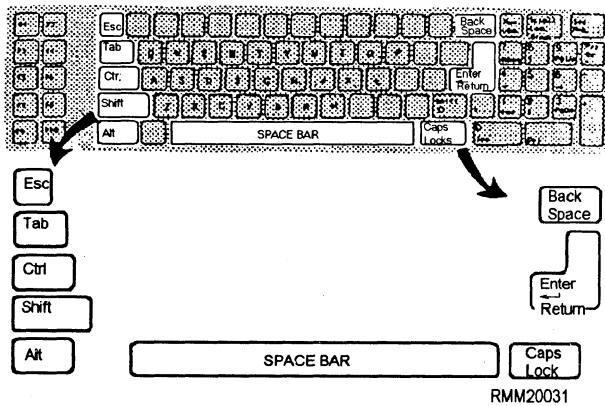

Figure 1-16.—Control keys.

CONTROL KEYS.— In looking at figure 1-16, you will notice several keys are outlined in bold. These are some of the more common control keys you can expect to use when working with just about any keyboard. Beginning in the top left-hand corner, you see the ESC(ape) key, TAB key, CTRL (control) key, SHIFT key, ALT (alternate) key, and to the immediate right are the SPACE BAR and the CAPS LOCK key. On the right-hand side of the keyboard are the BACK SPACE key and the ENTER/RETURN key. Depending on what program/software you are using, the keys may be assigned different functions.

- **ESCAPE KEY** The ESCAPE key usually stops the execution of a program or function.
- **TAB KEY** The TAB key moves the cursor to the next tab stop position.
- **CTRL KEY** The CONTROL key performs special functions within the system/program. It is used in combination with other keys to increase the number of functions you can specify to a system or program. For example, on most IBM compatible systems, when used with the ALT and DEL keys, it reboots the operating system.

- **SHIFT KEY** The SHIFT key works in conjunction with other keys. When you hold down the shift key (or depress the CAPS LOCK key) and press a letter key, the letter will be displayed and stored in UPPER CASE. When you hold down the shift key with the number keys on the row above the alphabetic keys, the special characters shown on the top of each key will be displayed and stored. The CAPS LOCK key on this particular keyboard contains a light within the key itself. When it is lit, you know the caps lock feature is on.
- **ALT KEY** The ALTERNATE key also works in conjunction with other keys to increase the number of functions you can communicate to the system/program.
- **SPACE BAR** Press the SPACE BAR whenever you want to enter a blank character, a space.
- **BACK SPACE KEY** Pressing the BACK SPACE key moves the cursor one position to the left, erasing the character that was previously entered.
- **ENTER/RETURN KEY** By pressing the ENTER/RETURN key, you tell the computer (microprocessor) you have entered data or instructions and are ready for processing. Depressing this key also returns the cursor to the beginning of the next line.

SPECIAL FUNCTION KEYS.— If you look at figure 1-17, you will notice once again several keys are outlined in bold. These are special function keys you can expect to use. Located on the far left side of the keyboard, you see 12 special function keys labeled F1 through F12. On some keyboards you will find these function keys have been placed across the top of the keyboard, above the letters and numbers. The number of these function keys may also vary. To the right of the keyboard is another group of special function keys.

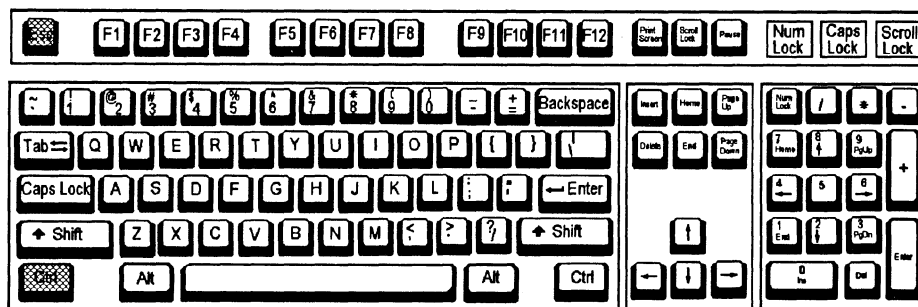

Figure 1-17.—Special function keys.

These include a 10 key (0-9) numeric keypad and the cursor control keys. Also, beginning on the top row at the right, you see the NUM(eric) LOCK key, SCROLL LOCK key, PAUSE key, and the PRT SC (print screen) key. Located on the bottom right-hand side of the keyboard are the INS(ert) and DEL(ete) keys. The purpose/function of each of these keys is as follows:

- **FUNCTION KEYS F1-F12** These special-purpose keys are used to communicate special functions to the operating system, such as MS-DOS, or to applications software. The meaning of each is defined by the particular software. This simplifies tasks that might otherwise require several keystrokes. These keys can also be used with other keys to increase the number of functions you can specify to a program.
- **NUMERIC KEYPAD KEYS** To activate the numeric keypad, press the NUM LOCK key. The NUM LOCK key may contain an indicator light within the key to indicate when it is **ON**. Use the numeric keypad just like a calculator keypad to enter numbers you will be using in mathematical functions.
- **CURSOR CONTROL KEYS** The CURSOR CONTROL keys are most important. They allow you to move the cursor from one place to another on the display screen. Remember, the cursor is the indicator, the spot of light on the screen, which lets the user know where the next entry will be made. On the keyboard shown in figure 1-17, the cursor control keys are located in two locations, both on the numeric keypad and as a separate keypad. When the NUM LOCK key is **OFF**, you can use the arrows on keys 2,4,6, and 8 to control cursor movement one line up or down, or one position to the left or right, as shown by the direction of the arrow. The remaining cursor control keys on keys 1, 3, 7, and 9 are used to move the cursor to other parts of the screen or document/data (for example, the end of a line [END key] or the top of the next page [PgDn key]). Some software packages use the cursor control keys in combination with each other or with other keys to increase the number of ways and the speed with which you can move the cursor. Read the software documentation; the faster and more efficiently you are able to move the cursor through a document or database, the faster and more efficiently you will get the job done. Some keyboards have separate arrow keys

for cursor control. This is particularly helpful when you are doing a lot of data entry of numbers.

- **SCROLL LOCK KEY** Applications software uses the SCROLL LOCK mode of the key to control screen scrolling.
- **PAUSE KEY** The PAUSE key is used to interrupt program execution.
- **PRT SCreen KEY** The PRT SCREEN key is activated by depressing it in conjunction with the SHIFT key depressed. This sends whatever is displayed on the monitor's screen to the printer.
- **INSert and DELete KEYS** These keys allow you to insert or delete a character at the position of the cursor when neither the SHIFT nor the NUM LOCK keys are depressed.

It is important to remember that any key or combination of keys can be assigned special meaning by a program. Therefore, the keys may have different meanings and functions, depending on the program you are using. Once again, we remind you, read all the documentation that comes with each program and with the computer system.

Disks and Disk Drives

Magnetic disks, regardless of their type or size, are, without a doubt, the most important secondary storage medium used with microcomputers. Disks provide fast retrieval of information. The disk's physical characteristics, flat and round, allow the disk drive **direct access** to data. Put simply, the processing unit goes directly to a designated disk drive, seeks out the specific location on the disk where the data is stored, and immediately retrieves it. The disk drive does NOT have to read through a series of records before reaching the one desired, as is the case with magnetic tape units. The two forms of magnetic disk typically used with microcomputers are the **floppy disk (diskette)** and the **hard disk**. Let's look at the sizes and construction of each and at the disk drive devices that read from and write to them.

DISKETTES AND THEIR DRIVES.— A diskette is also referred to as a floppy disk, or just plain floppy, because it is a round, flexible platter.

Physical Characteristics.— The platter is enclosed in a plastic jacket. At present, diskettes come in two sizes (diameters): 5 1/4 (5.25) inches and 3 1/2

(3.50) inches (see figure 1-18). The platter is made of a tough plastic that is coated with a magnetic oxide material, allowing it to be magnetized. The inside of the plastic jacket is lined with a soft wiping material that continuously cleans the floppy disk as it spins within the jacket. Look at figure 1-19; you will notice a hole in the middle of the diskette. It is referred to as the **center hub**. The hub makes it possible for the floppy disk drive's spindle to rotate the diskette inside the jacket. The **recording window** allows the read-write head mechanism of the floppy disk drive to come into contact with the diskette so it can read from or write data onto the diskette's surface. Located just to the right of the center hub is what we refer to as an **index hole**. This index hole (and corresponding hole [or holes] in the diskette), marks the first sector or starting point on the diskette. The sectors on a diskette are controlled by timing. On a soft-sectored diskette, the timing is controlled by the software; therefore, only one timing hole is needed on the diskette. On a hard-sectored diskette, the timing is controlled by the hardware, and the diskette has several timing holes.

Types of Floppies/Diskettes.— The diskettes you will be using must be compatible with the floppy disk drives on your microcomputer system. Diskettes can be **soft-sectored** or **hard-sectored**. Depending upon the disk drive's characteristics, the disk drive can record data on **one side** of the diskette or **both** and can record data in one of several bit densities, depending upon how the diskette is formatted.

When you are working with a soft-sectored diskette, you must use your microcomputer and a utility routine or program (in this case, a formatter program) to sector or format each diskette for you. On most microcomputer systems, using the **FORMAT** command will automatically sector the diskette for you.

If you are working with hard-sectored diskettes, then you need not format them. They have already been presectored by the manufacturer for your specific

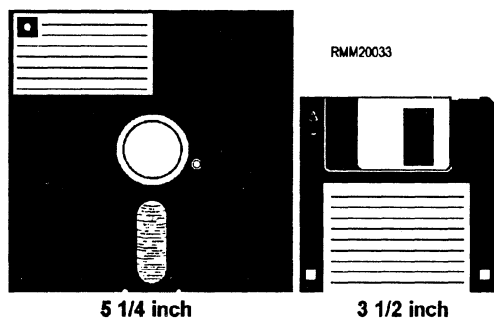

Figure 1-18.—Floppy disks/diskettes used on microcomputers.

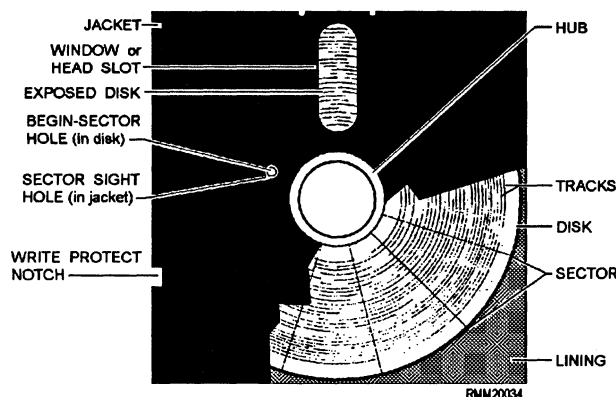

Figure 1-19.—A typical 5.25-inch diskette.

microcomputer system. Floppy disk drives that use hard-sectored diskettes read and write data faster. However, the diskettes are more expensive and can only be presectored (reformatted) for a specific system, such as an IBM compatible or a Macintosh.

Most diskettes sold today are soft-sectored because the wide range of microcomputers and their operating systems vary considerably in respect to sectoring requirements. For now, the important thing to remember about sectoring is the fact that no matter what type of diskette you are working with (soft- or hard- sectored), it must be formatted before it is usable for storing data.

Storage Capacity.— Although diskettes are relatively small in size, they can store a respectable amount of data. Some diskettes are **single-sided, single-density**, whereas others are **double-sided, single-density; double-sided, double-density; or double-sided, quad-density**.

When we refer to a diskette as being double-sided, double-density, what are we really saying? We are saying the floppy disk drive is able to read from and write to both sides of the diskette (hence, the term double-sided), and that each sector on the disk can store 512 bytes of information (instead of the 256 bytes that can be stored on a single-density diskette); hence, the term *double-density*. A diskette's capacity is also affected by the number of tracks per side. Therefore, if you wanted to know the total storage capacity of a double-sided, double-density diskette with 80 fifteen-sector tracks per side, then you would use the following formula to calculate the number of bytes:

bytes per sector (512)	=	512 bytes
times sectors per track (15)	=	7,680 bytes
times tracks per side (80)	=	614,400 bytes
times sides (2)	=	1,228,800 (1.2M) bytes

To review, multiply bytes (5 12) times sectors (15) times tracks (80) times sides (2). This gives the total capacity of the diskette, 1.2M bytes.

Write Protect Feature.— Like all other media, floppy disks/diskettes must also have a way of being protected from a user accidentally writing on them. This is accomplished with a **write-protect notch** (or cut-out) located in the upper right-hand corner of the plastic jacket (see figure 1-19). Whether or not the write-protect notch is covered to protect the data on the diskette depends solely on the disk drive manufacturer. For example, on most systems using 5 1/4-inch diameter diskettes, covering the write-protect notch makes it impossible to write on the disk's surface. However, the opposite is true on systems using 3 1/2-inch diameter diskettes. Uncovering the write-protect notch makes writing impossible. In short, find out which is which on your particular system before you accidentally wipe out an entire diskette's data.

Floppy Disk Drives.— Floppy disk drives are manufactured to read and write data in one of several bit densities for both single- and double-sided diskettes. A single-sided disk drive can only read a single-sided diskette. However, a double-sided disk drive, like the one shown in figure 1-20, can read both a single-sided and a double-sided diskette.

HARD DISKS AND HARD DISK DRIVES.— Although most microcomputer systems you will be working on use some type of floppy disk drive, you should also be aware that all micros also contain a small sealed unit called a **Winchester disk** or **hard disk drive**. Unless the disk drive is an external type unit, you might never know it was there. Floppy disk drives are easy to spot; all you have to look for is the drive's door, that open slot where you insert the diskette. Hard disk drives, on the other hand, are normally sealed

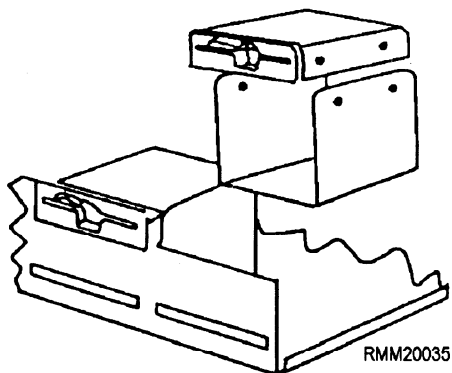

Figure 1-20.—A floppy disk drive being removed from system unit.

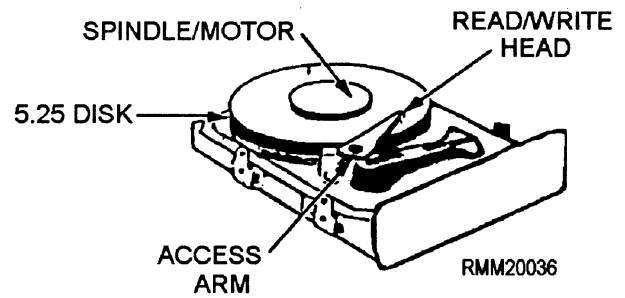

Figure 1-21.—Internal hard disk drive mounted on disk drive chassis.

units that can be tucked away just about anywhere. Generally, you will find them inside the system unit (figure 1-21) in the space occupied by one of the floppy drives.

Hard disk drives provide you with many timesaving features not available nor possible with the floppy disk drives. These include increased access speeds, greater storage capacity (up to 8 gigabytes [GB] of storage), and overall convenience. Working with hard disk is much easier because you can quickly end one program and start another, all through the operating system.

Hard disk units consist of **rigid** metal platters that are tiered or stacked. In most cases, the disks themselves are not removable, and for this reason can be hermetically sealed in the storage unit along with the access mechanism that contains the read/write heads. Because this type of disk drive is completely sealed and free from air contamination, the read-write heads can be positioned to within 20 millionths of an inch from the surface of the disk. This also allows the disk to be rotated at a high rate of speed—typically, 3600 revolutions per minute. Hard disks also comes in two sizes (diameters): 5.25 inches, and 3.50 inches, with 3.50 being the most popular. Their storage capacities range from 500 megabytes to 8 gigabytes, with the majority in the 1.2- to 2-gigabyte range.

As mentioned earlier, hard disks can be placed internally within the system unit, like the one shown in figure 1-21, or externally as a detachable unit, as shown in figure 1-22. You may have also noticed that the disk drive shown in figure 1-22 is a portable hard drive in that the hard disk is removable. The hard disks and read/write mechanism are enclosed within a rugged case. The result is a self-contained hard disk you can insert like a floppy and remove for reasons of security.

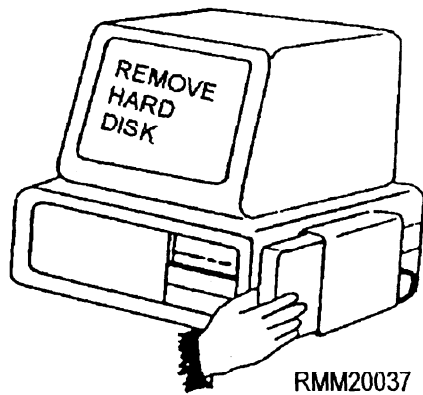

Figure 1-22.—External hard disk drive with removable disk cartridge.

Printers

Most printers you are likely to use while working on microcomputers are the low-speed varieties. They are able to print text at rates of 200 to 800 characters per second and usually output this information one character-at-a-time. After close examination, you will find that basically the only major difference between printers designed for micros and those used on larger mainframes is their size, and the speed at which they print. Other than that, they are very much alike in terms of setup, operation, and operational features.

Micro printers, like mainframe printers, are either impact or nonimpact. At least six printing technologies are used to produce hundreds of microcomputer printer models. These technologies include dot-matrix (which forms characters using a series of dots), xerographic, electrostatic, ink jet, and laser.

DOT-MATRIX PRINTER.— The dot-matrix printer uses a print head made up of pins. It creates the characters by using these pins to generate characters a dot-at-a-time. Dot-matrix printers have speeds that range from 60 to 350 cps.

XEROGRAPHIC PRINTERS.— Xerographic printers use a printing technique very similar to the methods used in duplicating or copying machines. The printers can operate at speeds up to 4,000 lines per minute.

ELECTROSTATIC PRINTERS.— Electrostatic printers use a special photographic paper that allows characters to be etched onto the paper using a stylus. The stylus, made up of tiny wires, forms characters by placing an electrostatic charged image on the paper. Then, as the paper is moved through a toner solution

containing ink particles, the ink adheres to the charges that form a pattern on the paper to develop the character. This type of printer can be used for both printing and plotting (displaying graphic output), and can print up to 5,000 lines per minute.

INK JET PRINTERS.— Ink jet printers employ a technique very similar to the way we use a can of spray paint and a stencil. A spray of electrically charged ink is shot (under pressure) toward the paper. Before reaching the paper, the ink is passed through an electrical field, which forms the letters in a matrix form. The print resulting from this process consists of easy to read, high-quality characters. Some manufacturers use large droplets of ink for faster printing, while others use small droplets for better clarity but with slightly reduced printing speeds. This type of printer can print up to 300 characters per second.

LASER PRINTERS.— Laser printers direct a beam of light through a rotating disk containing the full range of print characters. The appropriate character image is directed onto photographic paper, which is then put through a toner, developed, and used to make additional copies. The print resulting from this process consists of sharp, clean images that are easy on the eyes. These printers can print up to 20,000 plus lines per minute.

Many micro printers can print subscripts and superscripts, print in several different colors, print graphic material, and output text in several different type styles (fonts).

Some printers print in a single direction only, like the conventional typewriter, whereas others print in both directions (bidirectional) to save on time-consuming carriage returns. Many come with either a friction feed (for handling single-sheet paper) or an adjustable tractor feed (for handling continuous forms), and some even have both.

You can initiate a wide range of printer functions either through the applications program you are working with or by using the controls located on the front of the printer's operating panel. These controls can be buttons, lights, and switches. With a simple touch of a button, you can change such things as type style, letter quality, pitch, and spacing. It's that simple.

As mentioned, most printers are equipped with an operating control panel that allows you to change various settings. For example, you can change the number of characters per line or lines per inch, change fonts and type size, and switch from draft to letter-quality mode. You can choose any combination of

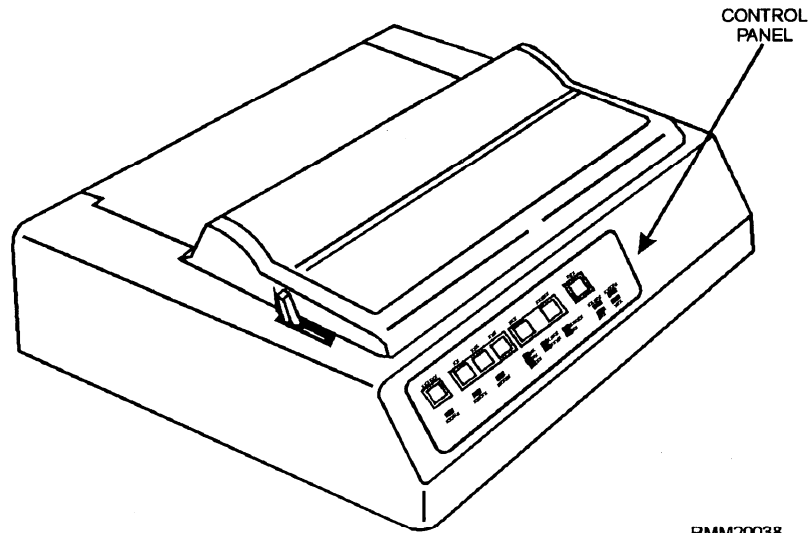

RMM20038

Figure 1-23.—Dot matrix printer showing operating control panel.

features quickly and easily. The printer we are using as our example is a dot matrix printer (shown in figure 1-23). Dot matrix printers are widely used with microcomputers in the workspaces. You will become very familiar with their operation.

PRINTER OPERATING CONTROL PANEL.— The operating control panel shown in figure 1-24 displays the buttons that control various functions along with several indicator and warning lights that show you what functions are currently in operation. Listed below are some of the more common CONTROL BUTTONS and INDICATOR/WARNING LIGHTS you are likely to see and use on this type of printer.

Control Buttons.—You can set up various functions and control printing functions by manually pushing control buttons. To activate the buttons, you must first put the printer in an offline status. Normally, this is done by depressing the online button.

- **ONLINE BUTTON** The online button allows you to put the printer in either online or offline status. When in online status, the printer is under the control of the operating system and

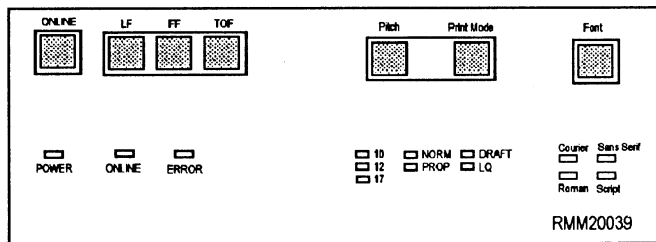

Figure 1-24.—Printer operating control panel.

applications program. When in offline status, the printer cannot receive data.

- **LINE-FEED (LF) BUTTON** The line-feed button allows you to advance the printer paper one line at a time every time you press it. On many printers, if you depress the line-feed button for more than 5 seconds, the paper feeds continuously line by line. Regardless of how this button is used, the internal line counter is incremented accordingly; therefore, the top-of-form position is never changed.
- **FORM-FEED (FF) BUTTON** The form-feed button allows you to advance the printer paper to the top-of-form (TOF) position (the top of the next page).
- **TOP-OF-FORM (TOF) BUTTON** Pressing the TOF button will advance the printer paper 1 1/2 inches and redefine the location of TOF on the paper. On this particular printer, it will not feed the paper to the TOF position, as it does on many of the high-speed printers you have operated.
- **FONT BUTTON** With the font button you can select between fonts, depending upon job requirements. If no selection is made, the operating system normally defaults to the courier font.
- **PRINT MODE BUTTON** The mode button allows you to select the quality of print. This

particular printer has two settings: draft mode and letter-quality (LQ) mode.

- **PITCH BUTTON** Use the pitch button to select the number of characters to print per inch. This particular printer has three settings: 10, 12, and 17 characters per inch.

Indicator and Warning Lights.— In looking at figure 1-24, you will notice indicator lights located above the control buttons on the control panel. They provide status information and show the functions or features currently in effect.

- **POWER INDICATOR** The power light lets you know that power is being supplied to the printer.
- **ONLINE INDICATOR** The online indicator tells you that the printer is in online status and is ready to receive output from the microprocessor. While it is in this status, normally, all other panel buttons are inoperative.
- **ERROR INDICATOR** The error indicator light **warns** you that there is a problem of some sort that makes the printer inoperable. This could be caused by a cover left open, the printer out of paper, an electrical malfunction, a paper jam, or possibly the font cartridge is not in place or is improperly seated.
- **FONT, PRINT MODE, AND PITCH INDICATOR LIGHTS** The lights located above each button and next to each feature tell you the current operating modes of the printer. The lights are lit next to selected features.

Accessories and Other Hardware

In addition to monitors, disk drives, keyboards, and printers, you may find a number of other attachments to microcomputer systems. These might include a mouse device, cassette tape drive, optical scanner, CD-ROM drive, switch box, modem, and so on.

MOUSE DEVICE.— You may have a mouse device attached to your micro. It allows you to freehand sketch or to select items from menus on the display screen. As you move the mouse, the cursor moves to a corresponding location on the display screen. For example, if you are selecting an item from the menu, you move the cursor to the item and press a button on the mouse to select the item.

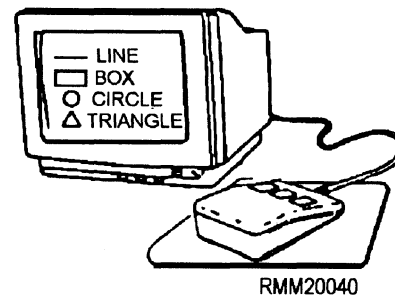

TAPE DRIVE.— You can use cartridge or cassette tapes to provide backup to the hard drive. The tape drive may be internal or external to the system unit. A tape drive makes a good, reliable backup system for the micro, since it holds 60MB or more of data. If a tape drive is not available, you can backup to floppy disks.

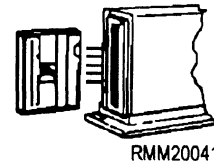

OPTICAL SCANNER.— An optical scanner can be used to scan (read) graphic art or text directly into the microcomputer. This saves redrawing or retyping.

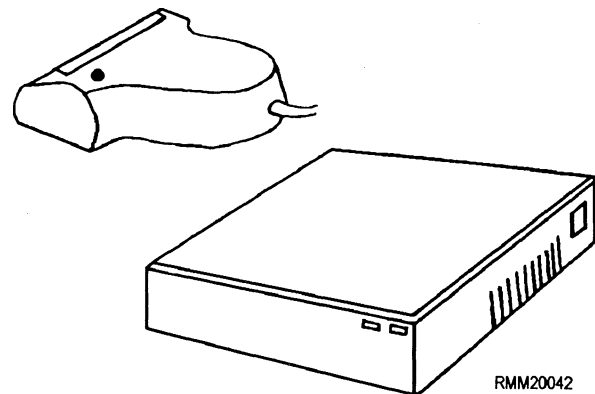

CD-ROM DRIVE.— You may have a CD-ROM (compact disk-read only memory) drive to read data stored on compact disks. CD-ROM technology is the same as that used for audio disks, except it includes routines for detection and correction of data errors. The CD-ROM drive can be internal or external to the system unit. Compact disks can hold a vast amount of information, 550MB or more. They are used when the same information is needed by many, and the information is fairly constant. For example, libraries can put all the information they need about documents and publications on a CD-ROM. On a CD-ROM, the

information, once recorded, cannot be erased or changed, but it can be read many times. The expression Write Once, Read Many (WORM) describes this type of technology.

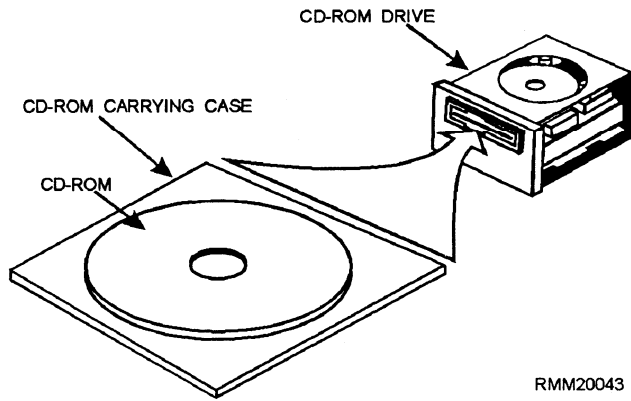

SWITCH BOXES.— When you want to share printers, you can connect them through a switch or switch box. For example, two or more computers can use one printer, or one computer can use two or more printers. As you can see, you will need a cable between the switch box and each device. You then switch the setting, A or B, on the box to switch signal lines without disconnecting and reconnecting cables. Switches range from this simple, manually operated switch box with two settings to switches that select signal lines automatically and provide buffering capability. Some also provide for both parallel and serial devices.

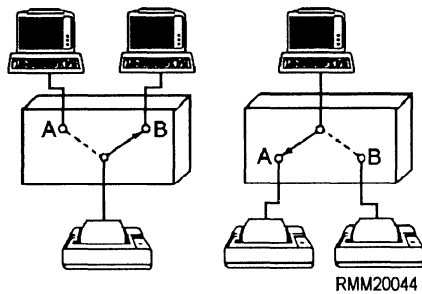

MODEMS.— Modems provide communication between systems. Through them, your system can send or receive data over phone lines. You may also use a null modem cable for communication between systems that are close enough to each other to be connected by cable. A null modem cable creates a communications link that allows devices to communicate without using modems and phone lines. To make the systems and null modem cable fit together, you may need a gender connector or gender changer to bridge two like connectors.

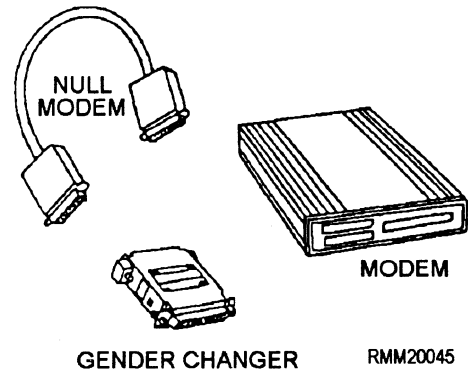

As you can see, a basic (low-end) system is only a beginning. As you become more familiar with microcomputers and as technology changes, you will find more and more capabilities and more uses for microcomputers.

SETTING UP AND OPERATING MICROCOMPUTERS

Before you begin to set up or operate a microcomputer, **know what you are going to do. THINK FIRST.** Start with the documentation, NOT with the hardware and software.

USING DOCUMENTATION

The first thing you will want to do when you install or start using a system or a new software package is become familiar with the documentation that comes with it. You will also want to see what other documentation and training materials are available. Don't get discouraged over the amount of reading material provided to you. It takes time to learn something new, and it takes practice to become proficient. Spend time learning all you can about the software and hardware. Refer to manuals and other help aides when you have problems. You may also have in-house user manuals to use.

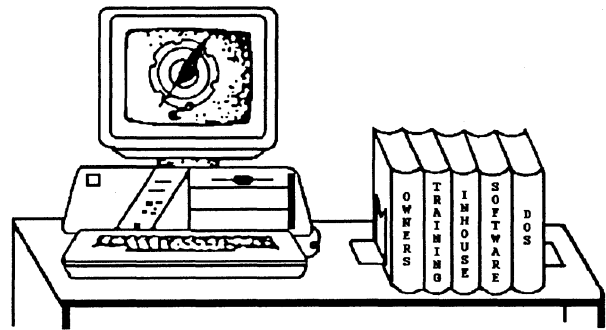

User/Owner Manuals

User/owner manuals will tell you about the hardware and how to install and configure it. Each device will probably have its own owner's manual. For example: the printer's manual will tell you how to connect the printer to the system, how to insert the paper and change a ribbon, how to use the tractor feed for continuous-form paper, what the lights mean, what settings you can change from the front operating panel, and so on. The owner's manual for the monitor will tell you whether the monitor is monochrome or color, what buttons and dials you can use to adjust the display, and so on. The **system owner's manual** will provide a system overview. It will tell you how to unpack and set up the system, how to power up the system, how to get the software running, and so on. **Disk operating system and applications software user manuals** will tell you how to install and use the programs. They will also specify the hardware requirements: processor type, memory size, hard disk needed, and so on.

Most manuals that come with the system and software will include sections with names like Getting Started, Installation, Using the Software/System/Commands, Reference, Error Messages, and Troubleshooting. A learning or self-study section may also be included. When you first begin, take the appropriate manual and look at the headings in the table of contents. Then browse through the appendices, glossary, and index to become familiar with what they contain. This will give you an idea of what information you can find in the manual and how the information is organized. For example, are the commands listed in a reference section in alphabetic order, or are they grouped by function in several sections? The more you know about where to find information when you need it, the more professional and confident you will be. One of the most frequently used sections in the operators manual is the section that covers the parameters. This section includes the factory settings, the other settings available, and how to change the settings.

Training Materials and Aides

Software packages often include an online tutorial on disk. If the package you are using has one, take time to go through it. It will give you at least an overview of what the software can do and how it works.

The system may also have hypertext. Hypertext is an online information system that can be incorporated into a software package, such as WordPerfect®. It is a data management program that allows you to very

quickly navigate through all sorts of information in connection with the applications program you are using. In this example, it would be WordPerfect®. An entire user's manual and applicable documentation is readily available to you with a couple of keystrokes. Hypertext, which can include text, graphics, video, and audio, is especially useful for users who do not have access to manuals or when documentation is stored out of reach.

Video, audio, or other online tutorial training materials may be available at your command. For disk operating systems that are in general use and for many software packages, you can obtain text books, training manuals, and supplementary manuals written by people other than the vendor. Local bookstores and libraries may have them.

Help Aides

Other help aides are help screens, keyboard templates, and quick reference cards.

- **Help screens** are part of the program and can usually be called on to the display screen at any time while the program is running. This means if you get stuck or confused about how to do some function when you are in the middle of a task, you can call the help screen function and have it display information relating to your problem.
- **Reference cards** usually list the features and the keystrokes that activate each feature.
- **Keyboard templates** fit over or above the keys. They identify each feature and its associated keystrokes.

These aides are very helpful, especially when you are jumping back and forth between a number of different programs that have assigned different meanings to the function keys. A quick look at a template or a reference card, or a call for a help screen, may be all you need to remind you of how something works. This is especially true once you have become an experienced user on a particular software package.

In-House User Manuals

To implement your own command's policy and procedures, you may have one or more in-house user manuals. These will generally cover the use of microcomputers, what software is to be used, any specially designed routines and programs authorized for use, standards for labeling diskettes and files,

backup procedures, maintenance procedures, security procedures, and so on.

Diagnostic/Troubleshooting Information

For performing diagnostics and for troubleshooting problems, there may be separate manuals or the information may be included in an appendix of an owner/user manual. Become familiar with the kinds of operator/user diagnostics you can perform. In this way, you may be able to identify and isolate problems. Error messages also provide information to help you solve problems. Usually, an appendix or special section will include a list with some explanation.

Most of the hardware components have built-in system checks that occur when the particular piece of equipment is powered on. If an error condition occurs during the self test, an error code or message is displayed. You will use this code or message to begin the troubleshooting. Get the manual and look up the error, this will give the cause of the problem and an action to take to fix the problem and clear the error condition. There are several commercial troubleshooting and information software packages available to use in performing system checks, each of which will include an operating manual on how to run and interpret the results. Remember to use the associated manual for whatever troubleshooting that you do.

INSPECTING THE COMPONENTS

Once the computer components arrive, the first thing that needs to be done is to inspect the components. This is accomplished in several steps:

- Inspect the boxes for damage before opening them.
- After opening the box, check to be sure everything is there (e.g., operating instructions, cables, and cords).
- Remove the components from the box, looking for damage (e.g., cracks in the case, loose connections, missing parts).

After checking over each component and making sure everything is there, it is time to begin connecting everything together.

SETTING UP THE HARDWARE

The first thing you must do when setting up the hardware is to read the installation instructions. They

will tell you what cables belong to what equipment and how to hook up the equipment properly. In the following paragraphs, we will give you an idea of what is involved when installing a microcomputer having a separate monitor, keyboard, and printer.

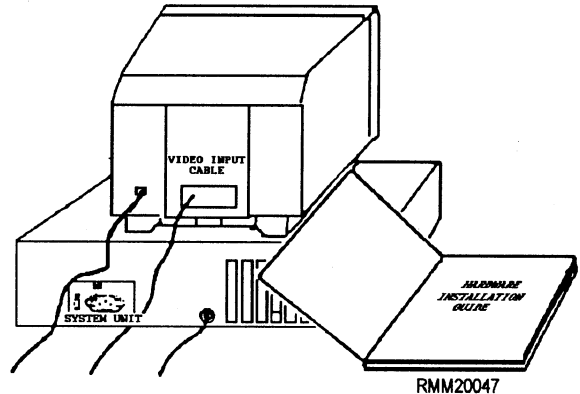

Normally, each device comes with its own power line cable (except the keyboard, which gets its power from the system unit). You plug each into an electrical outlet. Be sure all power cables are polarized, grounded, shielded, and have a three-conductor grounding plug. This brings us to another very important subject, power requirements.

Power Requirements

Most microcomputers can operate on voltages in the range of 100 to 130 volts or 200 to 230 volts alternating current (at). They are able to accommodate either voltage through the use of a selectable switch called a **voltage** or **line select switch**. The voltage switch on our particular microcomputer is located on the back panel of the system unit (see figure 1-25).

CAUTION

Changing the voltage switch to a different setting, say from 115 volts to 230 volts, would also require that the power cable be changed. Do NOT attempt to do this on your own; instead, have it done by a qualified electrical technician.

If you're not sure of the line voltage that is being supplied to the electrical outlets in your work space, have a qualified electrician check them for you. Further, it is recommended that the outlet you select to support your system be used only by the microcomputer system and its peripheral devices.

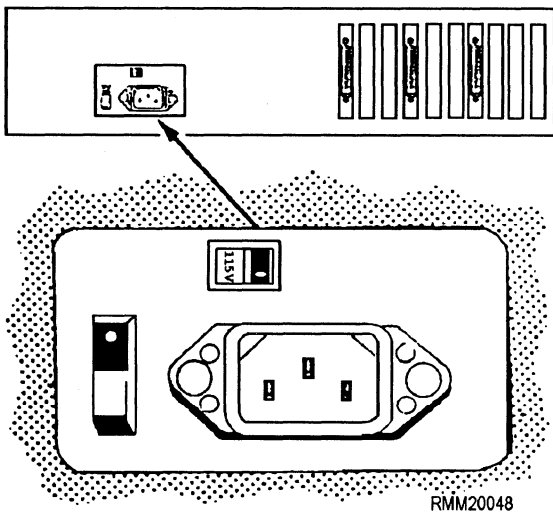

Figure 1-25.—Back panel of system unit showing voltage/line select switch.

Once you have determined that the type and amount of power are sufficient to meet the microcomputer's needs, you must attempt to prevent abnormal power fluctuations from damaging your microcomputer. With alternating current, you have what are called **peaks** and **valleys**. Valleys (also referred to as low voltage or brownouts) will not harm the computer or any of its related components. However, peaks (also referred to as high voltage or surges) can overload and literally burn up the computer's internal components. You can avoid these peaks/surges and protect the computer by using a **surge protector**, like the one shown in figure 1-26. This particular surge protector has a power strip capable of accommodating up to six components. It is advisable to first plug the system unit and its supporting devices into the surge protector, and then plug the surge protector into the electrical outlet, as illustrated in figure 1-26. This lets you turn all your equipment ON or OFF

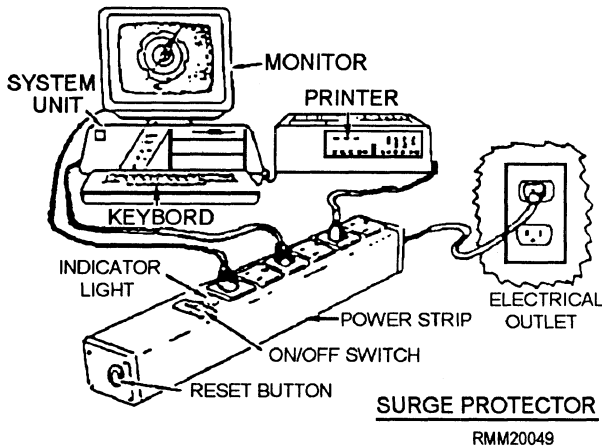

Figure 1-26.—Surge protector with computer and peripherals connected.

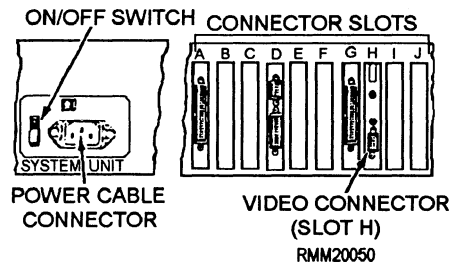

Figure 1-27.—System unit (rear view).

with the flick of a single switch. There are many varieties of surge protectors, and there is probably a particular type already in use in your workspaces.

The System Unit

In looking at the back of the system unit shown in figure 1-27, you will see a number of places called connector slots to attach cables. Remember, this is just an example. Each computer is different; refer to the owners manual for exact locations of the connector slots. You will also see the power cord connector. You will need to connect the monitor, the keyboard, and the printer to the back of the system unit. Before making any type of electrical connections, be sure the ON/OFF switch located on the surge protector is in the OFF position and that the plug is removed from the wall outlet. This doubly protects both you and the equipment; you from being electrocuted, and the equipment from being damaged.

Connecting the Monitor

Located on the back of most monitors is an ac power cable and a video input cable. You may also find a voltage selection switch (for 115/220 vac operation). Most monitors are designed to operate at either 115 or 220 volts ac, depending upon the setting of the voltage selection switch (shown in figure 1-28). Normally, they are preset at the factory for 115 vac operation. Should

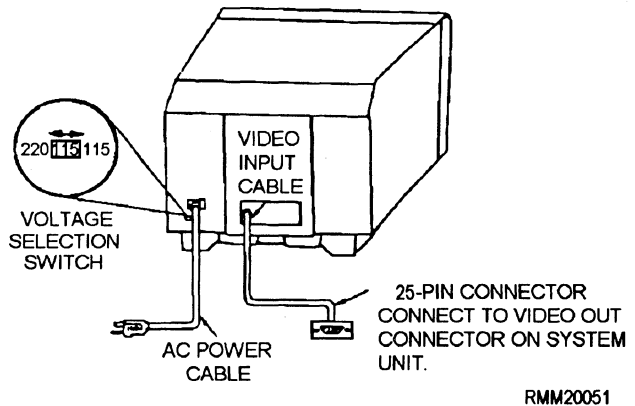

Figure 1-28.—Back of monitor.

your monitor have such a selection switch, be sure it is set for the proper line voltage. Then, plug the power cord into one of the receptacles on the power strip.

The video input cable has a twenty-five pin serial connector. Plug it into SLOT H on the back panel of the system unit, where the video display board happens to be located on this particular unit (see figure 1-28). Ensure that whenever you plug in a cable that it is properly and firmly seated and tightened down if the connector comes with screws.

Connecting the Keyboard

On the end of the keyboard's cable is a five-pin connector. Plug this into the back of the system unit to allow for communication between the keyboard and the system unit (see figure 1-29).

Connecting the Printer

Like the monitor, the printer has its own power cable and a data cable for communicating with the system unit. Since most printers can operate in either serial or parallel mode, it is important you look at the data cable to see what type of connector you are working with. Serial connectors are usually smaller than parallel connectors and contain fewer pins. After visually inspecting the data cable, connect it to the appropriate printer connector on the back of the printer (see figure 1-30). Should either the printer or data cable connector have some type of locking device (screws or cable locks), be sure to screw (or secure) them in place. Then, connect the other end of the data cable to the back of the system unit (slot D), as shown in figure 1-30. Once you have made this connection, connect the power cable to the back of the printer and plug it into the power strip.

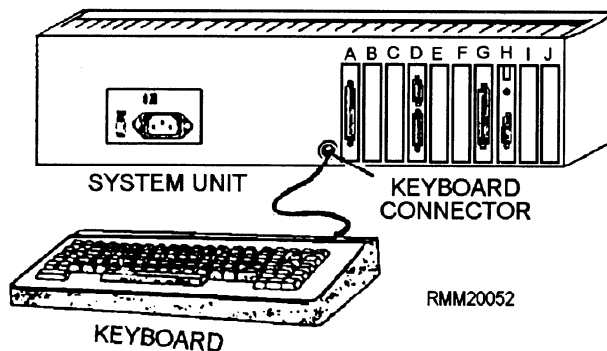

Figure 1-29.—Cable connection from keyboard to system unit.

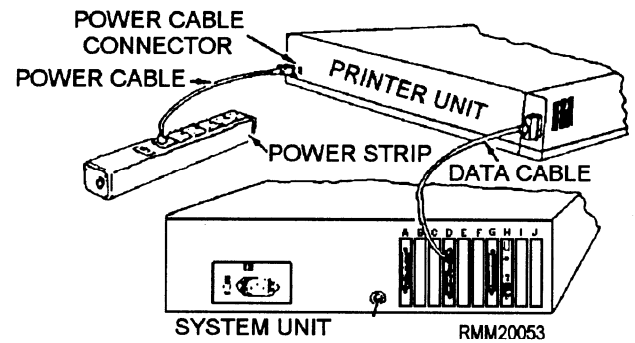

Figure 1-30.—Cable connections from printer to system unit and power strip.

Configuring the System

Once all of the hardware has been connected to the system unit and has power, you are ready to start configuring the system. In most cases, the system will recognize the hardware that was connected and make the changes on its own, but you need to know how to go into the system configuration to make changes. Each system has its own procedures to follow; so get the manual and read about your system and how to make changes.

To make changes you will need to get into the system setup. Normally, this is accomplished by pressing a key or series of keys when the system is booting up. From system setup, the following changes can be made:

- Date and time
- Memory size
- Floppy drives
- Hard disk type

All of this information is contained in the complementary metal oxide semiconductor (CMOS) chip. Since this is a memory chip, it requires a constant source of power, a battery. The battery used most often is a non-rechargeable lithium battery with a life expectancy of 3 to 5 years.

Inspecting and Repairing Cables

Although inspecting and repairing computer cables is not an everyday occurrence, you should know how to perform these tasks. When it comes to inspecting computer cables, there are several things to look for. Some of these are:

- Pinched cables
- Cut/broken cables
- Connectors/plugs pulled apart
- Bent pins
- Loose connections

Most of these problems can be avoided by taking your time when installing the cables, avoiding setting equipment on the cable, not pulling the cables, and tightening the connectors down.

The repairs that you will be expected to perform most often are:

- Straightening bent pins
- Tightening the connections
- Replacing broken cables

You will not be expected to re-pin a cable, since the equipment to perform this operation is very expensive. It is cheaper and easier to just replace the cable when it is determined that the cable is bad.

Preparing the Computer for Shipment

From time to time, you will be expected to prepare a computer for shipping out of the command. This occurs when a piece of equipment has to be returned to the manufacturer for some reason, or if the computer has to

be sent to another command. In either case, the equipment must be packed up and shipped out. When possible, use the original packing material, if available. Otherwise, make sure the equipment is wrapped and packed to avoid any damage. This can be accomplished by using heavy cardboard boxes, bubble wrap, and other cushioning packing material.

SUMMARY

With the completion of this chapter, you should gain a basic understanding of how digital computer systems work. A computer system is composed of hardware and software. Electronic digital computer systems consist of a central processing unit (CPU) with its primary storage and input/output (I/O) devices. The arithmetic-logic unit and control unit process both data and program instructions. Computers use stored programs to process data and solve problems. This provides a powerful method of automatic control. In addition to operating microcomputer system, you should become proficient at setting up, configuring, upgrading, and initializing them. It is important that you become familiar with computer system documentation, including user manuals and any software training materials and help aides. Among the microcomputer-related tasks you will be expected to perform are: inspecting, repairing, and installing cables; running system checks; and troubleshooting error conditions.

CHAPTER 2

COMPUTER CENTER OPERATIONS

LEARNING OBJECTIVES

Upon completing this chapter, you should be able to do the following:

- *Explain the use of trouble reports.*
- *Describe how to output and inspect data from a computer system.*
- *Explain the importance of maintaining optimal environmental conditions.*
- *Explain how to use the computer console to query and monitor the system.*
- *Describe virus protection software.*
- *Explain the use of AIS requests.*
- *State the procedures used in the media library to store and maintain media and transfer data.*
- *Identify procedures used for storage media destruction.*
- *Discuss administrative duties in a media library.*
- *Explain how to create, modify, delete, backup, and restore system directories and data files.*
- *Describe the system processes for performing system backups, executing application utility programs, and running batch jobs.*

You, as the computer operator, are an extremely important individual within your automated information system (AIS) organization. It is your efficiency (performing in the best possible and least wasteful manner) and your knowledge (knowing and understanding the theory, principles, and facts, coupled with experience) that help ensure the overall effectiveness of the AIS installation. You must be familiar with the various methods of controlling data and procedures. You must also know the operating steps and procedures of your assigned computer system.

Technical administration and support are important aspects of AIS facility management. You will be making hardware and software projection reports, software performance reports, hardware utilization reports, and trouble reports. You will be responsible for

implementing performance-tuning initiatives to improve computer system performance. You will be evaluating and maintaining user manuals. All these are technical functions needed to ensure the smooth operation of an AIS facility.

TROUBLE REPORTS

You will be responsible for submitting trouble reports, as discussed in chapter 1 of Module 1. Trouble reports are used in reporting any system problem involving hardware or software that you cannot correct. Remember, the report must be as complete as possible.

COMPUTER OUTPUT

Output from computer processing, the work that has been completed, may take the form of a printed document, magnetic tape, or magnetic disk or diskette. In all cases, you are responsible for and must ensure that all completed jobs run successfully. In addition, you are responsible for identifying and coordinating the various outputs for each job, and for initiating their correct distribution.

OUTPUT PRODUCTS

To determine whether a job (or system) ran successfully (to a normal EOJ) and that all processing steps were properly performed, you may have to review the computer console printout. This printout indicates such things as the number of input records read, the various input files updated, all error conditions (error messages) that the operator encountered during the run, and the resulting actions taken, the various output files created, and so on.

Most of the time, the computer console printout will provide you with the answers you are looking for when it comes to reconciling processing discrepancies. For example, it will inform you of the reasons certain output products, tapes, diskettes, or report listings, were not produced. Possibly the operator selected an incorrect program option, or the input parameters were incorrect or incomplete before starting the job. In short, you are responsible and also accountable for every job you work on, from the time it is submitted by the user until its delivery back to the user.

When checking the user's output, you should once again refer to the run sheet and/or task folder to verify that all items requested were, in fact, produced. If the output is in the form of magnetic tape, disk, or diskette, be sure it is labeled properly, given the proper classification, and it is on the appropriate media (magnetic media that has been designated for mail-out or distribution only).

When checking reports, make sure that they were run on the proper forms (size and type), that no pages are missing and the correct number of copies were printed, and that all print is legible and lined up properly.

Once it is completed, you then package each copy of the report, along with any other output products and the original input, place it in the proper pickup area, and log the job out in the job control log. You may need to notify the user when the job is ready.

If, during the course of checking over the user's output, you happen to come across something unusual or you find an error, by all means pull (reject) the job immediately, bring it to the attention of your superior, and notify the user of the delay. Even at this late stage, it is better to reject a job to correct any problems or discrepancies rather than release it, only to have it returned for rerun later.

OPERATING ENVIRONMENT

You work in air-conditioned environments that other AIS personnel (programmers, analysts, and so on) would probably consider intolerable. The coolness of the computer room or center is a constant source of discomfort. Computer rooms have to be kept at a constant and fairly cool temperature to ensure ideal operating conditions and prevent equipment failures. The humidity must also be controlled, for the protection of the equipment and storage media. This is accomplished by some sort of dehumidifier system. Although the requirements usually call for 70°F to 74°F, temperatures often range from 65°F to 70°F, and the humidity ranges between 30 to 60 percent. Fortunately for us, most minicomputers and microcomputers generate far less heat and humidity than mainframes during operation and, as a result, require only a minimal amount of cool air.

You will be using a hypothermagraph to monitor the temperature and humidity of the computer room. There are several different models and styles of hypothermagraphs, each with its own specific operating requirements. Check the operator's manual for the specifics of your equipment. The hypothermagraph uses a paper chart and marking pens to record the temperature and humidity. The chart is normally a 7-day graph showing the day and a number range. It uses two different colors, usually red for humidity and blue for temperature, to show the temperature and humidity on the chart.

COMPUTER CONSOLE OPERATION

CPUs aren't the computers you may have seen in the movies with all the blinking lights, although their basic functional units are still the same. The CPU of today, regardless of its size, still contains an arithmetic-logic section, a control section, and an internal storage (memory) section, as we discussed in chapter 1. However, today's CPU contains relatively fewer lights, switches, levers, and dials when compared to earlier models. So you may be thinking, but aren't all these

bells, whistles, and lights necessary so that I can communicate with the CPU and its peripheral devices? They really aren't.

At one time, systems like the IBM 360 series were characterized by dials, switches, and lights that flickered on and off. And although most of the switches and lights were primarily used by the maintenance technician or customer engineer, an experienced computer operator could tell you the status of the system just by watching the movement of the lights. These operators were able to detect when a program was in a loop, when a peripheral device became disabled, or when the CPU went into await state. The operator used some switches to manipulate the logic of the program or to enter data into the system; other switches and dials to display the contents of registers or data stored within main memory; and still other switches to perform special functions, such as single-cycling the computer through the instructions of a program.

Today, the communications mode between the operator and the CPU differs considerably from those earlier systems. We know the computer can communicate far more effectively with the operator (that's YOU) through a CRT and console printer than it does through lights or display panels. Now, you are able to communicate with the computer by entering the necessary responses through the keyboard of the console.

CONSOLE OPERATIONS

Depending on the size of the computer system you are assigned to, there may be one or more system consoles used to monitor the system. The consoles include a CRT and a keyboard, and may have a console printer. As a console operator, you are ultimately responsible for controlling the entire system. You are responsible for initial program loading (IPLing) or booting the system; starting jobs; monitoring jobs; responding to messages; and, most importantly, making decisions and taking care of any problems that may arise with regard to hardware and software. You are also responsible for directing the activities of peripheral equipment operators to ensure accurate response to job/run stream requirements. You are constantly monitoring system operations to determine whether programs appear to be operating correctly. You must be familiar with and know how to use the various types of control languages and statements that are used with computers.

Each system has a language designed to interact with the user's application program and the computer's operating system. These languages consist of control statements that are placed directly before the user's program to direct the operating system in its functions. The format of the control language statements differs greatly from one system to another. You will learn the specific control language used on your computer on the job. In addition to console-related functions, you must maintain records required to supplement the console log, including problem documentation and actions that were taken, computer utilization logs, file identification, and so on.

Console Keyboard

The standard keyboard has the same alphabetic key arrangement as a typewriter with a 10-key numeric keypad to the right, with special function keys located on both sides of the alphabetic keyboard. The special function keys differ, depending upon the console keyboard. The function keys are usually a different color from the alphabetic and numeric keys. By providing you with special function keys, the manufacturer has made it easier and faster for you to perform routine functions. Depending upon the software being used, some console keyboards use the top row of keys (0-9) as command function keys. The command keys cause such functions as automatic skip, enter, update, move, copy, end of job (EOJ), delete. The operator's guide usually provides documentation regarding each of the function keys. For the most part, console keyboard operations are relatively easy. Prompts are often displayed to help you in responding to messages, initiating jobs, and entering commands and data.

Configuration Changes

Computer system configuration changes take the form of both hardware and software changes. The addition of new hardware and software upgrades will affect how you do your job.

HARDWARE.— Changes to system hardware include the addition of new, the loss of existing, and the modification of existing peripheral equipment. You, as the computer operator, may be involved with helping to move the equipment, running cables, or removing cables, but the majority of the work is usually performed by maintenance technicians.

SOFTWARE.— Changes to the software include changing memory, buffer sizes, and hardware

addresses; and adding new application software. Changes to memory, buffer size, and hardware addresses require changes to the operating system. In addition, you must follow the manufacturer's instructions. Memory and buffer size changes are done when system performance has dropped because of increased use or changes to peripherals. By increasing memory and buffer sizes, the throughput time of the system is improved and the user access time is shortened. Hardware addresses are changed when there is a change to hardware status, such as the addition or loss of a piece of equipment. The addition of new application software will cause the system to be unavailable to users during the implementation. When the software arrives, it will include the installation instructions that are to be followed.

Powering Up the Computer

The CPU is normally powered up first; then one by one, each of the I/O devices is turned on. This is done to prevent a sudden surge of power that might overload the circuits. With the computer system powered up, you can then proceed to IPL the system.

Booting the System

Anytime the system loses power, is shut down, or becomes disabled because of a system crash, it usually needs to be rebooted or initial program loaded (IPLed). A system crash is the result of a hardware, software, or operation problem: a malfunction in the CPU, a programming error from which the operating system could not recover, or an operator error caused by an incorrect response to a message. Booting most systems resets all status indicators and reloads the supervisor (the executive-system program along with other resident routines) into the CPU memory. The manner in which the system is booted depends upon the computer system used and the software included in its operating system. Many of the larger mainframe computers store their operating systems on disk, and this disk is referred to as the SYStem RESident (SYSRES) pack. Once the disk unit with the SYSRES pack is in a ready status, you can then boot the system. Some systems are so simple to boot that all you need do is depress the start (or load) button on the CPU (or master console) and enter the date and time on the console keyboard. Some of the more complex systems may require you to take additional steps—assigning various I/O devices, partitioning (sectioning off) memory, and so on. It is because of these differences that boot procedures are well documented with each step explained to the point that

anyone, even someone unfamiliar with the system, could follow the step-by-step directions.

Computer Diagnostics

Computer diagnostics are of two types: those that are run when the computer is booted (called *internal diagnostics*), and those that can be run from a peripheral device (called *external diagnostics*).

INTERNAL DIAGNOSTICS.— Internal diagnostics are performed when the computer is booted and are designed to test the computer hardware. They return a pass/fail result to the operator. Some of the internal diagnostics are designed to test all or selected sections of the computer. An example of an internal diagnostic test is the power on-self test (POST), that checks the components upon power on.

EXTERNAL DIAGNOSTICS.— External diagnostics can be loaded into the computer from a peripheral (disk or magnetic tape unit) but initiated and controlled by the computer. These diagnostics are very thorough and offer the option of testing all or specific sections of a computer. They are more comprehensive than the internal diagnostics.

RESPONDING TO MESSAGES

Unless you respond correctly to a system- or program-generated message, CPU time can be lost, the wrong program options can be executed, and the system can even become disabled. As a console operator, you are the most important part of a team effort that makes computerized procedures successful. It is true that while complex operating systems make it easier for you to perform various tasks, correct responses to messages are just as critical. Never second-guess a response. Always refer to the proper documentation to determine the response needed. Manuals provided by the manufacturer, operator's manuals, and error message manuals should be located as near to the console as possible for your convenience.

Basically, you will be concerned with two types of messages: system-generated messages and program-generated messages.

System-Generated Messages

System messages are generated by the operating system software. To be more specific, it is the executive-program (the supervisor) that is responsible for monitoring and allocating the resources of the

system, and also for communicating with you, the operator.

While carrying out the instructions of an applications program or a utility program, the computer is in a program or problem state. While in this state, interrupts occur that return control of the system resources to the supervisor. When this occurs, the computer is in the supervisor or control state.

When an interrupt occurs, a message to the console operator may be displayed to indicate either a normal or abnormal condition. Some messages require a response on your part; others do not. "File XXX now being loaded," or "PAYROLL1 completed (EOJ)" do not require a response. Other messages, like "Printer Not Ready," or "No volume label found on pack XXX999," or "Insufficient memory allocated for job XXX" do require a response on your part.

You may be asking yourself, how do I know what occurred, and how do I respond to a system-generated message? **YOU FOLLOW PROCEDURES!** Most messages are coded, and you use this code to lookup the meaning of the message displayed. These types of messages are normally found in the software manuals supplied by the manufacturer. As you become more experienced, you will quickly become familiar with the different types of messages and be able to determine the origin of the message just by looking at the identifying codes.

Program-Generated Messages

Program-generated messages are those messages that are displayed by the program as the result of the programmer wanting to inform you of an available option or wanting you to supply data. The program might display a message such as "Enter expiration date," or "Option 1 to edit data, Option 2 to update file," or "Load four-part paper in printer."

Whenever a program message is displayed that requires a response, the run book/sheet along with the documentation (operator's manual, run manual) provided by the programmer should explain each and every response or option available and how you are to respond.

STARTING JOBS

As an operator, you will be expected to run utility programs and batch jobs. The start up procedures are similar for both; refer to the operator's manuals and run folders for the specifics for each job you run. The most

common application utility programs that you will run will be tape and disk copies, to make backup copies of application files.

While batch jobs are more detailed when it comes to starting them, as long as the run folder is followed there will be no problems. They will have different inputs and outputs required than utility programs. All of the file names and media types will be supplied by the user in the form of an AIS service request. Remember, before starting either an application utility or a batch job, look at and follow the operator's manual and run folder for the job.

DISPLAYING JOB STATUS

Using the system console, you can display, by their assigned name, the status of all jobs that are currently being executed. The job status also indicates whether the job is active, stopped, terminated, or canceled but still residing in the CPU; waiting for space in the work area or on disk; waiting for a printer or a communications line; or waiting for you to respond to a message. You can also display the status of the system's I/O devices to see whether or not they have been varied offline to the system.

One of your primary responsibilities is to maintain an awareness of the jobs currently undergoing processing within the system. Having the above information is extremely important to you, as it enables you to provide services to the various jobs being processed. The jobs with the highest priorities usually receive immediate attention. Jobs with lower but equal priorities are processed in the order they were entered (loaded) into the system (first-come first-served).

Considering these operating constraints, it is easy to understand why the system is in a continuous state of change. Through the use of the display command, you are able to get an immediate picture of the system's activities. Using this information as a frame of reference, you can determine what actions are necessary to maintain a continuous work flow.

RESTARTING A JOB

Unfortunately for us, not all jobs processed come to a normal end of job (EOJ). Things like program or machine interrupts, operator errors, bad input data, and incorrect responses to messages can cause a job to prematurely or abnormally terminate (ABORT). When this occurs, it is imperative that normal operations be resumed as quickly as possible. Error recovery must be

accomplished to maintain production schedules and minimize cost and lost computer time.

By monitoring the console (CRT or console printer), you can determine whether a job aborted because of invalid data or during processing. On some systems, the operating system software will display on the console the reason for the job's cancellation or the point at which the abort of the program took place. If the job aborted during the input phase, you may conclude that bad input data was at fault. If the input data was accepted and processing begun, you may conclude that a program malfunction was encountered (barring any hardware problems) and caused the job to be automatically flushed (canceled) from the system.

Regardless of why the job aborted, ultimately, you are responsible for initiating recovery from the job cancellation, using one of a number of methods. In many cases, the operator's manual or run manual will provide you with the proper procedures necessary to recover or restart a job. One method is to rerun the entire job. However, this could be very costly and time consuming, especially if the master file(s) had to be returned to its/their original state. You might have to recreate files from backup files and rerun programs that added, changed, and deleted records. This problem is especially true when working with disk files.

When the operating system supports checkpoint restart routines, a job can be restarted near the point where the problem occurred without having to rerun the entire job (or system). The logical point to take a checkpoint is at the end of reading or writing a tape file or after a predetermined number of records (say, 15,000) have been processed, or after so many minutes of processing (say, 30 minutes) have occurred. The programmer determines the points in the program at which the checkpoints are to occur. This way, if the program cancels (aborts), it can be started again at the last checkpoint.

Even if the system provides for an automatic restart at the last good checkpoint, you still must authorize the restart. Usually, a message will appear on the console indicating the job (or task) to be executed and the checkpoint for restarting the job. It is then up to you to either restart the job, postpone the restart until the cause of the problem can be determined, or indicate that the job is not to be restarted. Under no circumstances should the termination or cancellation of a job interfere with the continuous flow of processing within the system.

CANCELING A JOB

Among the tasks you may be asked to initiate via the console is cancellation of a job currently running within the system. The purpose of the cancel operation is to allow you to halt (stop) the processing of an application program and remove it from the system. A program can be canceled by either the supervisor control program or by you. Should the supervisor control program determine that an application program is not executable, it automatically directs the computer to cancel the program and, thereby, halt its processing. There are times when you must intervene with normal processing and flush a job from the system even though the program being executed may not have an error in it. For example, you could be instructed to process a higher priority job immediately. Unable to wait for the completion of the current program (job), you are, therefore, required to abort it. Don't become confused over the terms *cancel*, *flush*, or *abort*; they all have the same meaning. You may also be required to cancel a job because it has entered a continuous loop, been running way beyond the allotted time, or because it is trying to access a restricted file. You will find that there are many such reasons for having to cancel a program. There are times when you will cancel a program or a program will abnormally terminate (ABEND). This will require you to dump (print out) the contents of storage. This is known as a post-mortem dump. The system prints the contents of all the storage areas used by the program in the processing. This post-mortem dump is used as a debugging aid to help the programmer analyze the program.

Whenever a job is canceled or abnormally terminates, it is your responsibility to make an entry in the error/trouble log, giving the cause of the problem and as much detail as possible.

DOCUMENTATION

Documentation, who needs it? In data processing, we all do: for without it, we would quickly find ourselves in serious trouble. As a computer operator, if you want to know how to run a particular procedure, job, or system or learn more about a particular procedure, job, or system, the operator's manual or run manual is a good place to start. It can provide you with a wealth of information. Examples are a written overview of the system and systems flowchart, in-depth coverage pertaining to I/O requirements, file specifications (layouts), processing methods, job setup, error messages that might be generated,

recovery/restart procedures, and sample reports. As the console operator, you are responsible for running hundreds, possibly even thousands, of jobs on a regular basis. Without using the available documentation, even an experienced operator cannot understand or be expected to remember exactly how each job is to be set up and run.

The actual format of the operator's documentation differs, depending on your installation's requirements and SOPS. In some installations, you will find that each procedure or job has its own folder or notebook. Other installations may include an entire system (several jobs), such as personnel or payroll, in one large notebook. Regardless of how the documentation is formatted, its basic objectives are to provide you with complete instructions and to serve as a ready reference. So take the time to read the documentation. You will find that from knowledge comes the wisdom to make the right choice or the right decision every time.

SHIFT OPERATIONS

As you have probably realized by now, you have the prime responsibility for keeping the computer in an operational state. That is, you are responsible for the continuous and efficient processing of all types of program applications. Knowing this, it is essential that you acquaint yourself with the status of the system before working on the shift, whether it be on the day shift, eve shift, or mid shift. Before you assume control of the shift, you should be aware of its operational state. Normally, this information is obtained from the operators currently on duty, the shift supervisor, the various computer logs and run schedules, and by monitoring the activities of the system. In essence, you must examine those indicators that can reveal possible trouble spots or system malfunctions. For example, ask, what maintenance activities were accomplished, if any, on the previous shift(s)? what devices (pieces of equipment) have been varied offline (those devices which are not available to the CPU)? what other devices have not been fully operable? what maintenance activities, if any, are scheduled during your shift? and are any applications scheduled that are normally troublesome, difficult to handle, or prone to producing errors? Then ask about the work to be done on your shift, what jobs are scheduled to be run? are all the tapes, disks, documentation, and other various media and supplies present and accounted for? if not, have the appropriate personnel or organizations been notified—the librarian, data entry, or scheduling—to rectify the problem? This is important, for it ensures you

that the next job to be processed will be input to the computer system with minimum or no delay. In determining all these factors, you get a feel for what's going on and what is to take place during the upcoming shift—your shift.

In a production environment, personnel sometimes get too busy to finish a job or job step. Take that little extra time to stay organized, especially when it comes to the paperwork. Keep in mind and help other personnel understand the importance of being organized, and the problems that come from having too many things going on at one time. A misfiled or mislabeled tape can, at best, mean lost time either in locating it or recreating it. At worst, it can mean lost data and an unrecoverable problem.

You will find that most AIS installations overlap each of the shifts from 15 to 30 minutes. This allows you sufficient time to get acquainted with the jobs currently being run and provides continuity between shifts and operators.

Throughout this section, we have tried to make one point clear: you must learn to react quickly to situations that may affect the processing capabilities of the computer system. To accomplish this task, you must have a working knowledge of the operational aspects of your job. That is, you must understand what procedures to follow when specific errors arise, know where the operations manuals are kept and how to use them, know where the supplies to process jobs are stored (computer ribbons, paper, tape reflectors, and so on), who to contact in the event of equipment or program failures and errors, and what forms are used and for what purpose. Having a general knowledge of what to do is particularly important to you as a new operator just reporting aboard. You must adjust yourself to this new environment and learn where things are located as well as what should be done.

Regardless of the system you are working on, you must know how to use all the available resources, which include hardware, software, and people. Operators who are alert to the requirements of the total system and are able to understand and use the available resources play a vital role in the overall efficiency of the system, the department, and the installation. It is your performance as a computer operator that often determines the general attitude of users toward your installation. In developing a proper attitude toward your work, adhere to a code of ethics.

Job Monitoring

Although we would like to believe all jobs run without error, there are occasions when a program prematurely or abnormally terminates. It does not process to normal end of job (EOJ). When this occurs, the operator is expected to take whatever corrective actions are necessary to get the job going again. More often than not, the operator is able to recover a job by recreating a tape/disk file, moving the file to another device, or possibly cleaning the read/write mechanisms of the device prior to rerun. But, there are times when the operator will notify the I/O control clerk to assist in correcting the problem. Such would be the case when the input parameters are in error, the user's input is bad, or the job aborted because of an unrecoverable program error. In the event this happens, you maybe responsible for collecting all the data, both input and output, along with any memory dumps, and forwarding them all to the programmer.

During the recovery phase of an operation, the operator may need you to provide certain input parameters or tape/disk files before the job can be executed. Because of time constraints, a job that abnormally terminates may have to be rescheduled. If so, you may be responsible for seeing to it that the job gets rescheduled and that the user is notified of any job delay. We could go on and on, but by now you are beginning to get the picture. These examples are just a few of the many things that can get in the way of achieving a normal EOJ. We bring them to your attention to make you aware of the types of problems that can and do arise, and the manner in which you are to respond. Hopefully, you now know and are aware that monitoring a job means more than just calling up the operator to see how the job is progressing. It means you must oversee the job to its completion, doing whatever is necessary to help keep the job (or system) on track.

Virus Utilities

Virus utilities keep out viruses (malicious logic) that can attack computer system software. This type of software is normally designed to prevent both "known and unknown viruses" from invading a system, and detects and removes those already present. What is a virus? you might ask.

A virus is a self replicating, malicious program segment that attaches itself to an application program or other executable system component and leaves no obvious signs of its presence. And just like any bacterial disease, it can spread from disk to disk.

Viruses take advantage of the sequential step-by-step process that the computer follows. The virus is read into the computer via a peripheral device (tape drive, diskette drive, communication device, and soon) from a previously infected software application. The virus then inspects the first few instructions of each program until it finds a program that does not begin with the same instructions as itself. Then it attaches a copy of its own instruction set to the front of the program being examined. The spread of the virus comes from inspecting and duplicating itself. Execution of programs may seem to appear normal until the virus strikes. A virus can destroy data files and programs, depending on its design. Be particularly careful about putting new software on your computer; if it contains a virus, it can infect your other programs and data, giving you big problems. Your ISSO and Naval Computer Incident Response Team (NAVCIRT) can assist you in the detection and eradication of the virus.

Processing AIS Service Requests

Your first task may be to receive jobs from users. Each job will have an AIS service request of some type. A typical AIS service request is illustrated in chapter 1 of Module 1 (figure 1-2). In looking over this form, you will notice that it provides you with all the information needed to run the job.

LIBRARY FUNCTIONS

As a librarian, your job encompasses many duties and tasks vital to the smooth operation within your installation. Usually, you will find that there are instructions and/or standard operating procedures (SOPS) to help guide you along in different areas of library procedure and toward establishing a highly functional library.

But what about you? What should you know or be aware of when working in the AIS media library? The answer to that question is the topic of our discussion: library functions. Put briefly, as a librarian, your job is to become as proficient as possible in the different areas of library management, by learning all the ins and outs, you might say. You will need to know how to receive, handle, maintain (condition, clean, and retire), store, issue, and transfer magnetic media. You will be working with a minimum of supervision and will have to work well with other people to provide the needed services in a timely manner.

As the AIS librarian, you can be expected to perform any one, several, or all of the following tasks:

- Keep an adequate supply of magnetic media (scratch tapes, initialized disk packs, diskettes, and cassettes) available in the library and/or in the computer area ready for use.

- Retrieve and file magnetic media in accordance with command policy.

- Maintain a current inventory of all magnetic media. Control tapes (save tapes, work tapes, and scratch tapes) on a rotational basis.

- Test tapes for quality, and clean and degauss tapes and disks according to prearranged schedules or upon release by programmers and in-house users.

- Ensure that all magnetic media is acclimated to the atmosphere in which it will be used for at least 24 hours before releasing it for use.

- Inspect new tapes and install BOT and EOT reflectors if not provided by the manufacturer.

- File newly created tapes after checking the identification tape reel number against the tape strap number (if used) and verifying that the security classification on the label matches that on the tape reel.

- Refile previously created tapes, being careful to scrutinize each as if it were a newly created tape.

- Strip tapes (by removing the first 100 feet) when the error rate increases and replace the beginning-of-tape (BOT) reflector. If a tape has damage to its end, remove the last 100 feet and replace the end-of-tape (EOT) reflector.

- Keep all system tapes and disks in good condition at all times.

- Maintain a record of tapes and disks that have been cleaned by stamping the Julian date on a cleaning label on the back surface of the tape reel or disk pack canister.

- Clean disk pack covers according to schedule or as the need arises.

- Maintain and distribute tape and disk error and usage reports.

- Maintain control of certain required data files, program files, and various types of microforms (microfilm/microfiche).

- File all library materials in a neat, organized, and uniform manner.

- Have a standard operating procedure (SOP) instruction manual, indicating all library procedures, readily available.

- Have an adequate supply of save (external) labels and classification labels available for the computer operators.

- Check all user submitted save labels with job/run request sheets to ensure they are correct.

- Check save labels to ensure they indicate no more than a 90-day save request, and that only one 90-day extension is granted before the tape is copied to another tape.

- Ensure all users annotate, initial, and return their weekly copy of the release report, indicating what tapes are to be scratched, cleaned, degaussed, stripped, or mailed off-site; or any other action they deem necessary.

- Collect a copy of the save labels from the operators for the tape library tape/disk database file (only if the site has an automated tape library control system) and supported software.

- Maintain off-site storage of tapes and disks for disaster recovery.

- Maintain a current list of all foreign (outside) tapes and disks received and return them on schedule.

- Ensure fire-fighting equipment in the library is maintained and inspected by appropriate personnel (fire department, damage control petty officer, and so on) in accordance with command policy.

- Update fire-fighting instructions as necessary.

- Maintain the correct temperature and humidity in the library.

- Maintain security requirements and access to the library area.

- Ensure unauthorized persons do not remove magnetic media or related materials from the library.

- Promptly report any and all problems to your supervisor, leading chief, or other appropriate personnel in accordance with standard operating procedures (SOPS).

As you see by this list, there is a lot to do. In anyone day, you may perform one or many of these tasks.

Practice being a good communicator, and adopt orderly work habits.

RECEIPT OF MAGNETIC MEDIA

One of your jobs will be to receive magnetic media from the manufacturer (new tapes, disks, or diskettes). The first thing you should do is check the shipping container for obvious damage, such as crushed corners, holes, and the like, as shown in figure 2-1. If you find obvious damage, closely examine the media to determine whether damage has occurred. In case of damage, the affected media must be disposed of in accordance with command policy or contract specifications.

Physically check magnetic tapes for damage. Get in the habit of looking for such things as broken or warped flanges and damage to the outer edges of the reel. Also, check for damage to the wrap-around strap (see figure 2-2). Examine disk packs for broken or cracked dust covers (see figure 2-3). In addition, visually inspect each and every disk surface for physical damage and warpage. Also, check the air filter located on the bottom spindle of the pack to ensure that it is in place and correctly inserted (mounted).

When you examine tapes, check to ensure that reflective tape markers, the beginning-of-tape (BOT) marker, and end-of-tape (EOT) marker are physically located and properly placed at the beginning and at the end of the tape. Should your command have a tape cleaner or tape cleaner/certifier similar to the one shown in figure 2-4, by all means use it to check out the placement of the reflectors as well as to ensure that nothing is internally wrong with the tape. Remember,



RMM20054

Figure 2-1.—A damaged tape shipping container.

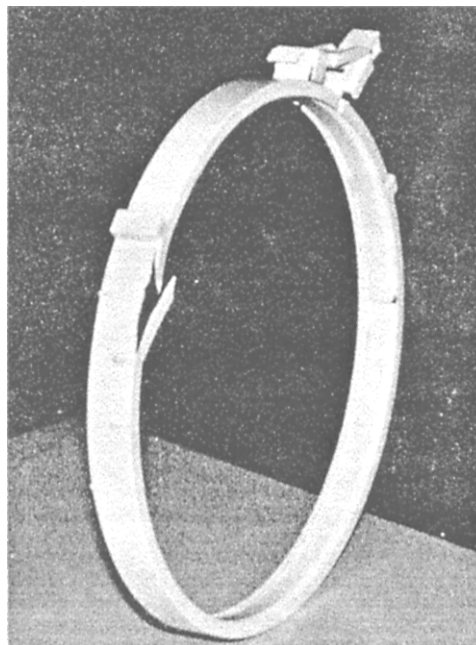

RMM20055

Figure 2-2.—Damaged wrap-around strap.

new does not necessarily mean good. If a tape cleaner or certifier is not available, you may be able to use the computer to check out the tape. Some computer systems have software programs that will allow you to test a tape while it is on the tape drive. However, to use this method, you must be allocated computer processing time.

Before releasing magnetic media from the library for use on the computer, you must ensure that the media has been properly labeled and prepared (prepped).

LABELING MAGNETIC MEDIA

We use two types of labels for magnetic media. The first type is placed on the outside of the media itself and

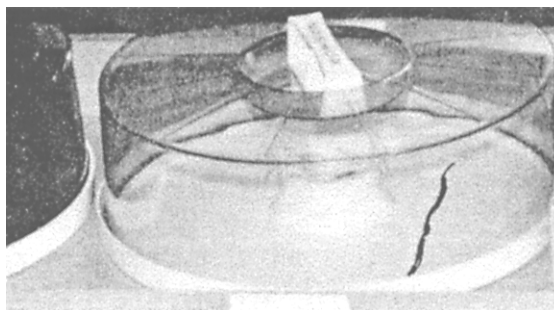

RMM20056

Figure 2-3.—Damaged disk dust cover.

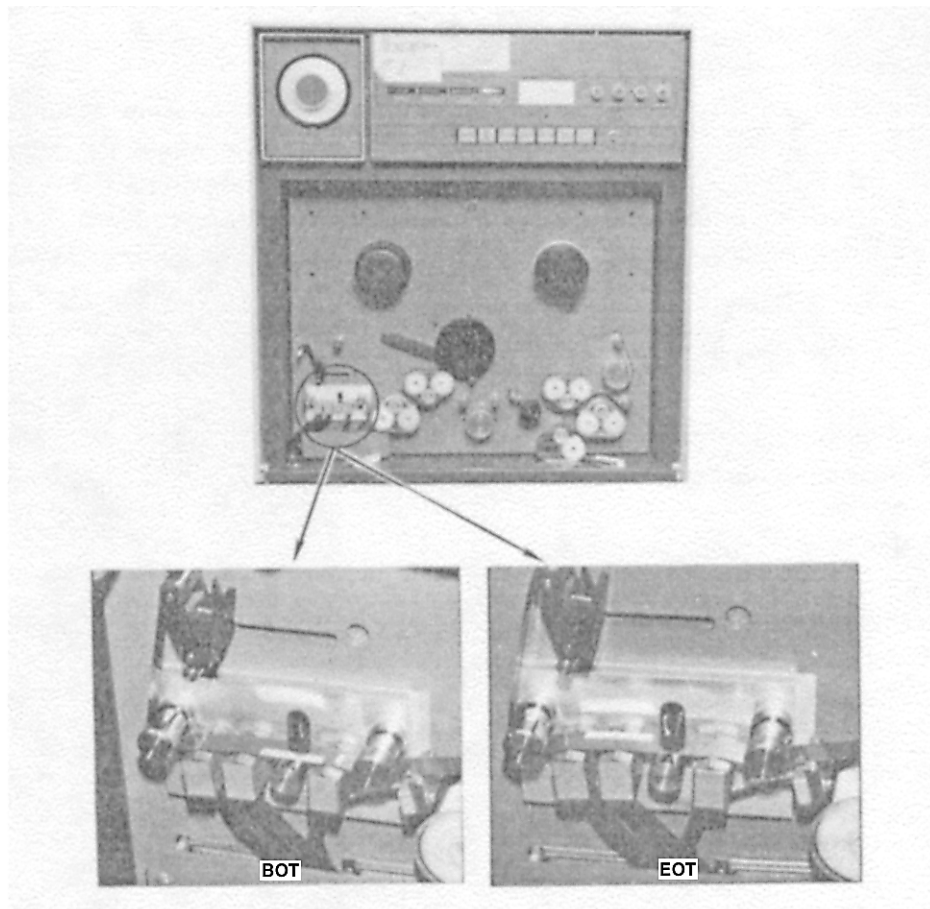

RMM20057

Figure 2-4.—Checking for BOT and EOT with read/write head.

is referred to as an external label. External labels are the labels we are interested in. The second type is written directly onto the media and is referred to as an internal label. Internal labels contain information that is needed by the executive control programs (systems software) of the computer to allow for the proper functioning of applications programs.

External Labels

External labels are considered permanent or nonpermanent, depending on their purpose (see figure 2-5). The two types of permanent tape and disk labels are the identification label, which indicates the number that has been assigned to the media; and the certification label, which indicates the last time the media was certified (tested for its reading and writing capability). Nonpermanent labels include usage labels to tell you how often the media has been used on the computer, cleaning labels to indicate when and how often the media has been cleaned, and save labels to indicate the file or

files that are contained on the media. As the magnetic media librarian, you are responsible for initiating and maintaining the first four types of external labels: identification, certification, usage, and cleaning

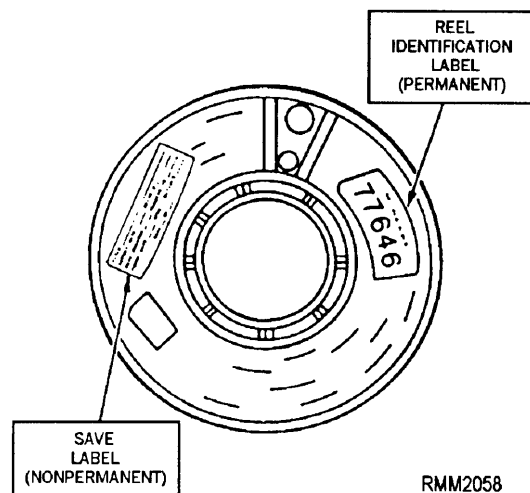

RMM2058

Figure 2-5.—Examples of media labels.

labels. The programmer, user, or control clerk is responsible for the save label.

PERMANENT LABELS.— The permanent-type label comes with a special adhesive backing; and when applied to a surface such as the flange of a magnetic tape, it adheres permanently. That is not to say this type of label cannot be removed, but to remove it takes a considerable amount of effort. Normally, you would consider using this type of label only if it were to remain on the media throughout its life cycle, as is the case with the identification number or certification labels.

Identification Label.— The identification number (label) contains a series of letters and/or numbers (usually from 3 to 8 characters in length) that tell you where the magnetic media resides in the library (see figure 2-5). It is a permanent home address, you might say. Your responsibility is to ensure that whenever new tapes and disks are brought into the library be properly numbered. If the tape or disk is a replacement for one that is no longer usable, you must be sure to dispose of the old media and physically remove the identification label.

Certification Label.— The certification label is used to indicate the last time a magnetic tape or disk underwent certification. Diskettes are not normally certified, but, instead, are disposed of upon receiving an unacceptable number of unrecoverable read/write errors. It has been found to be more cost effective to simply replace this type of media with new rather than putting it through a refurbishing process.

NONPERMANENT LABELS.— The non-permanent type label has a special adhesive backing of stick-on-type construction that can be applied to just about any kind of surface yet be removed with very little effort. This type of label is most useful in applications where information regarding the media itself, or what is written upon it, changes quite frequently. Usage labels, cleaning labels, and save labels are usually nonpermanent type labels.

Usage Label.— The usage label is used to determine how many times a tape has been read from or written to. It can be placed on either side of the tape reel. The usage label is normally made up of several boxes or circles (approximately one-quarter inch in diameter), which are filled in (one at a time) by the computer operator each time a tape is used. Notice that we did not mention disks. Disks are normally sent outside of the command for cleaning. At that time, they are also certified for use. However, magnetic tape is an entirely different story. After so many uses a tape must undergo

a cleaning, and that is where you come in. Every time a tape is returned to the library, you should make it a point to check the usage label to see whether or not it requires cleaning. A magnetic tape maybe cleaned at any time. However, if the tape does contain live data (data still needed), try to be extra careful not to damage the tape during the cleaning process. Normal operating conditions in the computer room require the read/write heads to be cleaned at least once every 4 hours of operation and the entire unit once every 8 hours unless usage is very heavy or as specified in the SOP. If this is done, a tape should be cleaned after every 5 uses, and the number of uses between cleanings should never exceed 10.

Cleaning Label.— The cleaning label is used to indicate when and how often a tape has been cleaned. This is important to know, for after a tape has undergone so many cleanings (usually 10), it should be put through a certification process to determine its accuracy (reading and writing capability). Normally, you place the cleaning label on the backside of the tape, since the information it contains is useful only to you, the librarian.

Save Label.— Whenever a tape is to be saved for a period of time, a save label, such as the one shown in figure 2-6, is required for accountability. The save label (also referred to as a user label) contains information that helps to identify the job/task number and the data file(s) written on the media, along with other related information. This label is placed on the front side of the media so it can be readily seen by all. Each individual programmer, user, and, in some cases, the control clerk (depending upon command policy) has responsibility for filling out as much information on the save label as possible before job submission. He or she normally enters such information as: job or task number, file identification, security classification, purge date, and/or its period of retention (30,60, or 90 days). When the job

JOB/TASK # _____	FILE I. D. _____
CLAS _____	REEL # _____ OF _____
CREATION DATE _____	SYSTEM _____ DR. # _____
PROG INIT _____	CTRL CLERK INIT _____ OPER INIT _____
PURGE DATE _____	RETENTION PERIOD 30 60 90

RMM20059

Figure 2-6.—Magnetic tape save label for unclassified (UNCLAS), Privacy Act (PRIV), and For Official Use Only (FOUO).

is run, the operator inserts the remaining entries: reel sequence number(s), the creation date of the file, the system on which the job was run, the magnetic tape unit (the drive #) that was used to create the tape, along with his or her operator number or initials upon completion of the job. These newly created tapes are then forwarded to the library, where you (the librarian) check to see that all required entries on the save label have been made. If there are discrepancies, it is your responsibility to notify the appropriate personnel so that corrective action may be taken. Once you are satisfied that all label entries are correct and complete, you can then proceed to log and file (store) the media for future use.

Whenever you are asked to pull (retrieve) magnetic media (input tapes, disks, diskettes), you should ensure that save labels accompany the job request for all outputs to be saved. Do this before releasing the job to the computer operator.

Internal Labels

Before releasing new magnetic media from the library, you are sometimes required to put the media through what is called an internal labeling or initialization process. As the librarian, one of your many jobs may be to perform this labeling or initialization process. Why? you might ask. Good question. Some computer systems require an internal label of some sort to be physically written on the magnetic media for validation (checking) purposes before the media can be accepted and processed by the system software and applications programs of the computer.

When dealing with magnetic tape, the internal label consists of two blocks of information written immediately after the BOT marker. The first block is normally reserved for the identification number, which is assigned by you at the time a new tape is added to the library. This identification number never changes. The second block identifies the information to be stored on the tape, along with the file ID. It may also contain date information that is used by special programs to further identify the tape and to protect the information from being destroyed prematurely. This type of information is normally provided by the programmer. You must schedule computer processing time to set up the internal label.

Like magnetic tape, whenever you introduce a new disk or diskette into the system, it, too, must undergo an internal labeling process known as initialization.

Initialization is somewhat similar to an initiation. If the disk pack (or diskette) passes a series of tests, then it gets to become a member of the library. If not, then the media is normally boxed up and shipped back to the manufacturer. To initialize a disk pack, you must have computer processing time at your disposal and a special program called a direct access storage device initialization (DASDI) program. The initialization procedure itself is designed to accomplish two things. First, during the DASDI procedure, an internal volume identification is recorded on track zero of the disk. Without this volume identification label, the computer cannot access the disk. Second, for a new pack, a surface analysis of the entire disk (or disk pack) is performed, defective tracks are flagged, and alternate tracks are assigned. In addition, a listing is produced that reflects the overall operating condition of the pack. This listing is normally retained in the library or in the technical support branch.

As you travel from one command to another, you will find that there are many DASDI programs available, under just as many names: INIT, FORMAT, and so on. The one you use will depend upon the system's hardware and its executive software.

DISASTER/OFF-SITE BACKUP

Have you ever given any thought to how much time and money are invested in the library? If you are not working in the library at the moment, next time you visit one, look around and try to imagine how much money it would take to replace the equipment and the media, and how much time it would take to recreate all the necessary files if everything were totally lost because of fire or flooding. Depending on the size of the library and the types of media it contained, it could run into the millions of dollars. Remember, data entry personnel do not work for nothing. The loss of these media can have harmful effects on your command's operations for quite some time. And, as we have already noted, recreation of files can be extremely costly.

All systems software, master files, and other critical entries and documentation should be duplicated as backup on a regularly scheduled basis and stored in a protected area, as far away from the library as possible. In spite of the many precautions that can be taken to protect the security of the computer center and the media library, the safest possible means of protecting data and information of a vital nature is the off-site, back-up procedure. This is true because there is no totally fail-safe procedure to protect a computer room or the library from the many dangers to which it is exposed.

It is up to the individual programming branch supervisors, operations supervisor, or division chief to ensure that all projects, systems, or jobs under their cognizance or control be identified, duplicated, and stored off-site in accordance with local Continuity of Operations (COOP) instructions.

Off-site magnetic media should be changed each time the data/information is updated. In the case where daily updates occur, backup files should be minimized to once a week if at all possible.

As librarian, you should have an established standard operating procedure (SOP) to copy master files for the various types of media, for use in the event the originals become damaged. Copies should be made each time a master file is updated. These copies can be the actual COOP tapes/disks or duplicates, depending on the proximity of the COOP storage site and the delay in operations required to retrieve the copies. If the COOP site is distant from the operation, the COOP files should be duplicated and the duplicates stored within the library for fast recovery.

SHIPMENT OF MEDIA

Occasionally, you will be expected to ship media to another site. The most important thing to remember to do before packaging a tape or disk up for shipment is to make a copy. There is nothing worse than mailing off a disk or tape and the recipient finding it blank when it arrives, and you don't have another copy.

The following steps should be followed to prepare media for shipment:

- Pull media from the library
- Copy the media, returning original to library
- Box media in shipping container
- Label container
- Affix warning labels on all sides

The warning labels should state that the package contains magnetic media; do not xray.

CARE AND HANDLING OF MAGNETIC TAPE

While it is inevitable that computer tape eventually acquires errors, you can help minimize tape errors through proper handling techniques. Tapes should never be handled unnecessarily, because each time you

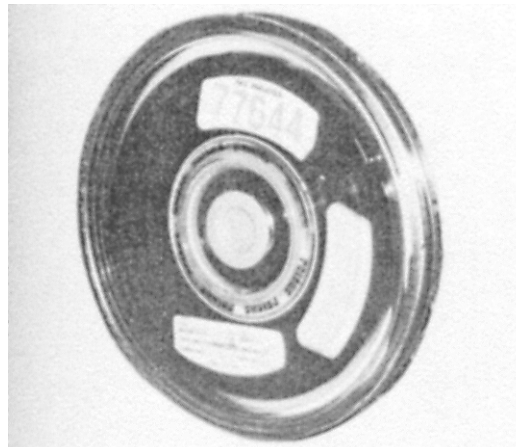

RMM20060

Figure 2-7.—Magnetic tape in a canister.

handle a tape the possibility of damage increases, especially to the outer edges of the tape. Devices, such as canisters and wrap-around (tape) straps, help protect the reel and tape during handling and storage. The canister tape seal shown in figure 2-7 offers the maximum protection against dust and physical abuse. Canisters provide a dust-free environment and support the tape reel by its hub. Canister tape seals are normally supplied by the manufacturer, unless your command specifically asks for another type such as the wrap-around strap.

Some AIS installations prefer to use wraparound straps, better known as *tape straps*, instead of canisters because they are far less expensive and take up less storage space in the library, figure 2-8. Unfortunately, tape straps do not provide the same degree of protection from dust or physical abuse as do the canisters. It is

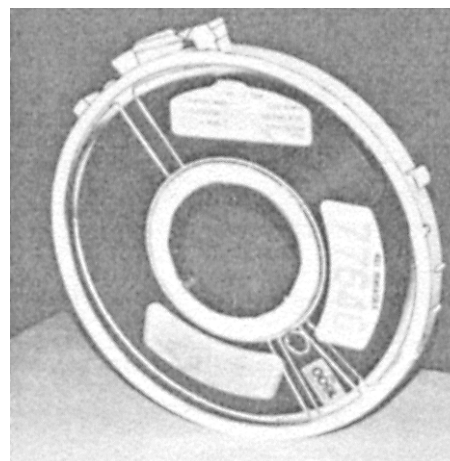

RMM20061

Figure 2-8.—Magnetic tape in a wrap-around (tape) strap.

possible for a person to squeeze the reel flanges during handling even though a tape strap is properly in place, as shown in figure 2-9. Handling tapes in this manner will certainly result in tape-edge damage. In addition, defective or improper size straps may deflect (twist or warp) the reel flanges, causing tape-edge damage. Nonetheless, when handled with care, the wrap-around tape strap can be an effective method of tape protection.

Anytime you are handling magnetic tape, regardless of how it is protected (by a canister or a tape strap), always use good judgment and follow the applicable safeguards, as follows:

- When a tape is not actually being used, keep it in its protective container to avoid accidental breakage and unnecessary contamination.
- Do NOT leave empty tape canisters open as this allows entry of dust or other tape contaminating matter.
- Hang wrap-around straps in a clean area while the tape is in use.
- Whenever you return a tape to its respective canister, you must ensure that a clean stopper is used.

NOTE: A stopper is a one-inch piece of foam rubber the same width as the reel (inside the flanges) and one-half-inch thick. Stoppers are used to keep the tape from unraveling once inside the canister.

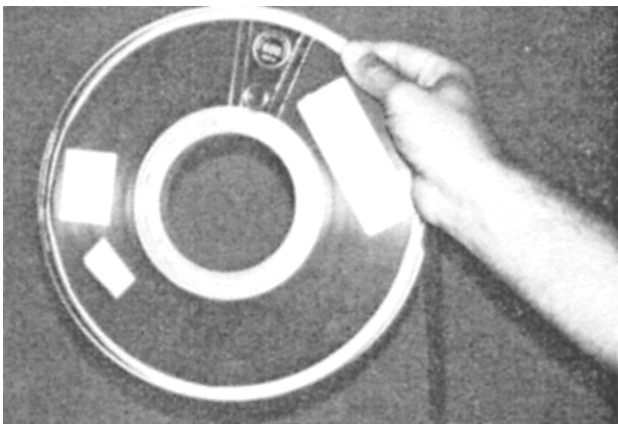

RMM20062

Figure 2-9.—Magnetic tape being held improperly—the fingers should go through the hub hole without squeezing the flanges.

- Never use rubber stoppers with wrap-around straps. The extra thickness could result in the tape being embossed (leaving a permanent imprint).
- While working with tapes in canisters, canisters may be stacked for short periods of time.

NOTE: Avoid stacking more than 10 canisters, since weight can cause the canisters on the bottom to crack.

- Avoid stacking tapes with wrap-around tape straps, because doing so can cause tape-edge damage.
- Store magnetic tapes in a vertical position.
- Always handle tape reels by the center hub, never by the flanges.

NOTE: If you happen to drop a tape reel, check it immediately for cracked flanges and the tape itself for possible edge damage.

- Periodically remove and check inside the flange and hub areas of take-up reels on tape cleaning and certifying equipment for dirt or other contamination. Also check these reels (at the hub) periodically for signs of warpage or cracks. Periodically check the mounting hubs on your equipment to ensure they are tight (secure). This prevents a reel of tape from wobbling during a cleaning or certifying operation.
- When you mount a tape on a device, always push in on the hub itself, never on the outer flanges.
- Never touch or handle the recording surface of the tape.
- Never place magnetic tape on top of equipment because of the heat generated by the equipment and because internal magnetic fields within the device may scramble recorded bits of information on the tape.
- Smoking should not be allowed in working spaces where magnetic tape is being used. Smoking is never permitted while handling magnetic tape, attending to tape units, or working in the library area. Ashes may contaminate tapes, and live ashes may cause permanent damage if they come in contact with the tape.

- And last, but not least, always follow the rules and procedures that have been established by your command or installation. Check your SOP manual.

Remember, anytime your library personnel are to handle magnetic media, whether it be issuing, receiving, filing, scratching, inventorying, or mailing, they need to be on the lookout for certain things. They must look for such things as tapes that are unevenly rewound, write rings that have not been removed from a newly created file, cracked tape flanges, worn tape straps, broken or cracked tape canisters, faded or peeling file identification or reel identification labels, mismatched tape reel number against tape strap number, and soon. Media with problems such as these should not be released for use or filed in the library until the problems are corrected.

TAPE PROBLEMS CHECKLIST	
<ul style="list-style-type: none"> • Tape unevenly wound • Cracked flanges • Cracked / broken canister • Faded / peeling label • Mismatched reel # with tape strap • No write ring in scratched tape • Write ring not removed from a read - only tape 	 RMM20063

CARE AND HANDLING OF MAGNETIC DISKS

As the librarian, you are primarily concerned with the care, handling, retrieving, storing, and labeling of magnetic media. When we care for magnetic media (especially disks or diskettes), an important element of that care is cleanliness. Disk packs, as well as diskettes, have a tendency to attract dust, smoke, oil, hair, you name it, and a disk pack will attract it (or at least it seems that way).

Because even tiny particles can cause problems, it is imperative that all AIS spaces (including the media library) be as contamination-free as possible. For you, that means all disk pack file drawers must be kept closed when not in use. Vacuum the disk pack covers

and storage cabinets on a regular basis (at least once a week) to prevent dust buildup.

It also means you must examine disk pack filters as often as possible (preferably after every use) to ensure there is no dust buildup or damage of any kind. If dust buildup or damage to the filter exists, by all means, replace the filter before it is to be used again. Be sure no foreign objects or notes are placed inside the disk pack covers. Foreign objects have a tendency to fly and, as a result, could slip between the disk platters and become undetectable until the disk pack is used. This would certainly cause severe damage to the pack and drive and make your maintenance technician very unhappy. If, for any reason, you suspect a disk pack has been damaged or dropped, under no circumstances should you release it from the library until it is checked out by a person using an authorized pack cleaner/certification device.

Anytime you are retrieving, storing, or just plain handling a disk pack, always carry it by the handle located on top of the cover, as illustrated in figure 2-10. The handle is designed in such a manner that the pack is supported at its center by locking the cover to the spindle on the pack. You must ensure that the bottom cover of the pack is firmly secured (attached), while holding the pack vertically by the handle. You should never set the pack down onto the bottom cover. The locking knob, which is cone-shaped, could puncture the pack's filter or possibly bend the disk's lower platter.



RMM20064

Figure 2-10.—Magnetic disk should be carried level, using the dust cover handle.

CLEANING AND RECERTIFYING MAGNETIC TAPE

How important is tape cleaning and recertification? Let us answer that question by asking another question: When do you suppose tape failures are most likely to occur? If you answered, when the tape is being used on the computer system; then you are correct. Consider this example: an unrecoverable tape error appears while the operator is trying to read in reel four of an eight-reel master file; the operator is about 3 hours into a very important job, and finds out there is no way to recover (restart) the job starting with reel three of the input. A failure at this stage of the operation gets the operator and a good many other people very upset, for we all know that reruns are costly in both time and money. Such failures can be avoided if tapes are cleaned and recertified on a regular basis. It is well worth the effort to properly care for tapes according to a regular planned schedule; since this avoids upset and inconvenience and gives your users confidence that your AIS facility is running smoothly.

Careful and planned maintenance of magnetic tapes can minimize and even possibly eliminate a lot of lost computer time. The first step in every magnetic tape maintenance program is, obviously, careful cleaning. Despite the many safeguards against contamination, you can believe that magnetic tape will eventually acquire some contamination and cause read or write errors.

You will find the greatest number of tape errors normally occur in the first 100 feet of a reel. When this is the case, the appropriate action is to cut off the contaminated area, relocate the BOT reflective marker, and continue to use the tape (see figure 2-11). In most

cases, the reduced length will not detract from its usefulness.

This procedure is known as *stripping* a tape. After a tape has been stripped five times, it should be reloaded (transferred) onto what we call a mini-reel. A mini-reel is about half the size of a standard reel of tape.

If the errors continue throughout the length of the tape, you should determine whether the errors are distortion errors or dirt errors. Distortion errors are usually the result of careless handling (abuse) of the tape and can rarely be corrected. Distortion errors can be seen as wrinkles, creases, turned-up edges, or a slight stretching of the tape. Dirt errors usually result from the accumulation of microscopic foreign matter on the tape surface and can be removed by careful cleaning. To do this, you need to use a tape cleaner.

Tape cleaning is the process of removing all foreign particles (known as residual buildup) and protruding debris from the oxide and back side (the shiny side) of the tape. This process does not destroy any of the data that has been previously recorded on the tape.

New tape has a tendency to shed oxide particles near the surface for approximately the first six passes through the read/write heads of the magnetic tape unit. Unless the new tape is cleaned at least twice, increased tape unit head wear could result. You will also find that deterioration of the edges of the tape is the major cause of most tape-generated debris. Edge guides that help to direct the tape along the tape path also cause a constant edge-scuffing. This results in a further breakdown of the oxide/base layer interface of the tape. An effective

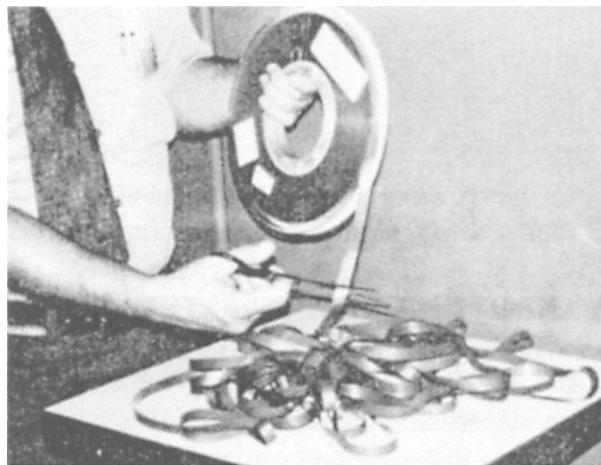

RMM20065

Figure 2-11.—A 100 feet of contaminated tape being removed from reel (stripping).

process to clean a tape is to use a magnetic tape cleaner/certifier similar to the one shown in figure 2-12.

Knives are used to remove any protrusions from the oxide surface. It is estimated that a maximum of 90% of all tape errors are removed in this manner.

Most tape cleaners clean tape by wiping the oxide and back surface of the tape. Loosened dirt, oxide particles, and other debris are removed from the tape by wiping assemblies. When the EOT marker is sensed by a photoelectric cell, the tape is automatically reversed, and the wiping assemblies clean the entire length of tape in the opposite direction. The wiping tissue used is made of a special textured fabric and is wound on a spool.

It is important to change the wiping material frequently at the point of contact with the tape. This is done to avoid entrapment and retention of abrasive dirt particles at the tape surface being wiped. Some tape cleaners, like the one shown in figure 2-12, move the wiping material along automatically.

In addition, most tape cleaners repack the tape as it rewinds, using a built-in machine programmed tension arm. This feature helps to relieve irregular tape pack tension, thereby reducing the possibility of tape deformation inside the tape reel. The repack tension arm is shown in figure 2-12.

Tape cleaning equipment that combines tape cleaning and recertification (figure 2-12) operates in the following manner. Any protrusions are removed by a knife edge during the first tape cleaning pass. At the same time, the location of every error that was not removed on the tape pass is indicated on a recording

chart (figure 2-12, upper left-hand corner). The location of each error is identified by its distance from the beginning-of-tape (BOT) reflector. On the second pass, that is the return pass, the certifier stops at every unremoved error area and the operator, using a microscope, endeavors to remove the error with a sharp knife or scalpel. Upon completion, a recertification operation will usually restore the tape to a near error-free condition. On a 2,400-foot tape reel, each recertification operation averages 15 minutes.

All tapes—scratch tapes, work tapes, save tapes, and data tapes—should be cleaned after every 10 uses or every 90 days, whichever is more frequent. All tapes should have a cleaning label attached to the back surface of the tape reel. Each time a tape is cleaned, you should log the Julian date and initial the cleaning label.

Some helpful measurement criteria, used by several of the AIS installations for determining retention or disposal of magnetic tape, areas follows:

ABSOLUTE-END-OF-LIFE— The tape contains so many flaws (errors) that it can not function at all.

PRACTICAL-END-OF-LIFE— The tape can produce usable results, but because of cost and annoyance of failures, it is impractical to use it any longer.

LEVEL-OF-REJECTION— This is a judgment call and must be based on your past experience or expertise, you might say. Some librarians and management personnel feel that after a tape is cleaned, if 15 write errors occur throughout the tape, then the tape has reached the threshold of rejection.

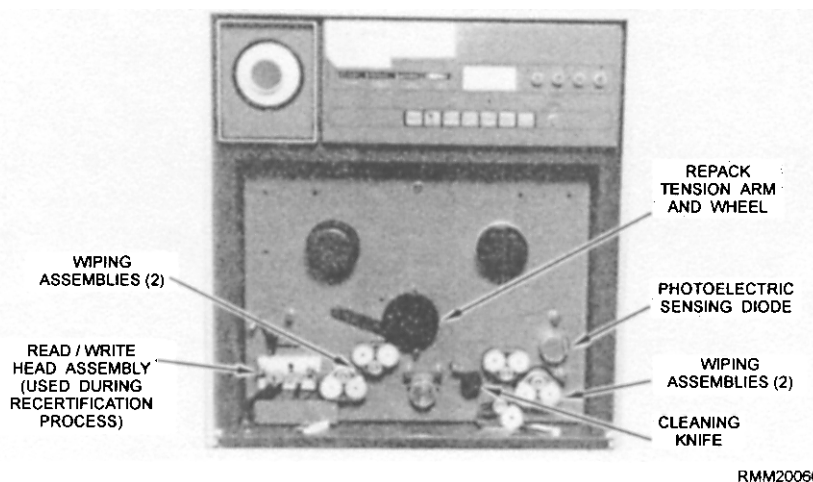

RMM20056

Figure 2-12.—Tape cleaner/certifier.

TAPE-REPLACEMENT-LEVEL— This is the point at which the number of errors exceeds the rejection level.

Maintaining Magnetic Media

Maintaining media involves using specialized library equipment to clean, certify, and degauss magnetic media. It also involves seeing that media is in usable condition. The duties and responsibilities include the following:

- Splicing leaders onto magnetic tapes
- Placing BOT/EOT markers on magnetic tape
- Rotating tapes and disks
- Inspecting and changing disk pack filters
- Setting up and operating tape cleaners, certifiers, and degaussers
- Mounting and dismounting magnetic tapes
- Performing cleaning, certifying, and degaussing functions
- Performing emergency shut-down/power-off procedures on equipment

Setting Up, Operating, and Maintaining Equipment

Be sure you and the head librarian know and can explain the steps involved in setting up and operating equipment. Be able to demonstrate the proper way to clean, certify, and degauss magnetic media. Be sure all library personnel know how to properly perform emergency shut-down/power-off procedures on the different types of equipment used in the library (tape cleaner, certifier, degausser, and remote computer terminal, if used).

Like any area with equipment, some operator maintenance is required to assure proper functioning and also to increase the useful life of the equipment. Operator maintenance on tape cleaners and certifiers should be performed on a regular basis and include the following tasks:

- Removing and replacing cleaning blades
- Removing and replacing wiping tissues
- Removing dirt/dust from photoelectric cells
- Ensuring tape pack wheel is rotating freely

Ensure that proper and regular operator maintenance is performed on the library's equipment. Keeping a log of when it was conducted and when it should be done again will help. Make sure outer cabinets are kept clean and free of dust. All dirt, oxide particles, and other debris should be removed from the capstans, turrets, tape pack wheel, and cleaning blades. Cleaning blades should not be allowed to become nicked or dull. Also see that the wiping tissues are clean, and are rotating smoothly and automatically.

CLEANING AND RECERTIFYING MAGNETIC DISKS

Today, the removable and interchangeable magnetic disk pack is one of the most frequently used mass storage media. Not only is it small, fast, and reliable, but with the proper care and handling, it has an almost indefinite life span. Like magnetic tape, the main enemy of the disk pack is dirt. During the manufacturing of the disk packs, every precaution is taken to maintain a sterile environment and a contamination-free assembly of each component of the disk. However, these safeguards do not entirely prevent some contamination from occurring, and everyday operation continues to increase the contamination level until data checks (read/write errors) do occur.

During normal computer use, three different types of errors are encountered on disk packs: temporary errors, permanent errors, and disastrous errors (head to disk contact or head crash).

TEMPORARY ERRORS OR SOFT DATA CHECKS— These temporary errors are the direct result of a minor buildup of contaminants, such as dust, smoke, and oil.

PERMANENT ERRORS OR HARD DATA CHECKS— These permanent errors cause data to be lost because of an excessive buildup of contaminants. As a result, the read/write heads are no longer able to access this particular area on the disk.

HEAD TO DISK CONTACT OR HEAD CRASH— These disastrous errors are caused when a read/write head of the disk drive unit comes into direct contact with the surface of a disk platter. Again, this is the result of an excessive buildup of contaminants.

These errors can be prevented by inspecting and cleaning the disk pack. Although none of the major disk pack manufacturers recommend a regular schedule for cleaning of disk packs, they do recommend that disks be cleaned and inspected when they have been exposed to

possible moisture or contamination. The fact is, during operation, the disk pack is surrounded by dirt and grease particles that are circulated through the air by the cooling fans of the disk drive; consequently, there is a definite need for a cleaning procedure, if not an actual schedule. If your installation has a disk cleaner/certifier, learn how to use it, and you will find fewer disk errors and a significant decrease in the number of computer reruns. A well-organized disk management program will serve to eliminate head crashes caused by contaminants; decrease, if not eliminate, hard data checks; and decrease significantly the number of soft data checks encountered.

DEGAUSSING MAGNETIC MEDIA

Degaussing magnetic media—tapes, disks, and drums—involves a process in which you demagnetize the media itself. This rearranges all the 0 and 1 bits, sort of mixing them up, you might say. Normally, the only time you would be required to perform such an operation is when you must declassify (remove the data from) the media before the media can be scratched for reuse. To remove a previously recorded magnetic signal (all the 0 and 1 bits), use a concentrated magnetic field to magnetically saturate the oxide coating of the media and randomly orient all the magnetic particles.

Magnetic Tape Degaussing

To degauss a magnetic tape, you must pass the entire tape through controlled fields of alternating current to reduce the signal level of the magnetic tape's recordings to a level which is below the capability of ADP equipment to interpret. This requires that signal level reduction be performed on the entire reel of magnetic tape, including the tape leader and tape trailer.

For a tape 1 inch or less in width to be considered unclassified by the National Security Agency (NSA) standards, the signal on the tape must be reduced a minimum of 90 dB (decibels) below saturation level after degaussing. The manufacturer's recommended operating procedures should be followed when degaussing a tape. Also, the tape degausser should be checked at least quarterly by technical personnel to ensure proper operating level specifications.

Before degaussing a tape, you should remove the tape wrap-around strap to prevent the reel from jamming, and secure the end of the tape with a foam rubber stopper to prevent the tape from unwinding. The degaussing operation itself takes no more than 2

minutes per reel for a magnetic tape with a maximum one-inch width.

Magnetic Disk, Diskette, and Drum Degaussing

Rigid magnetic media such as disk and drum storage, as well as diskettes (also known as floppy disk), should be machine cleared (overwritten), using a specially designed computer software program. Once the media has been overwritten, it should be verified (checked) to be sure the read mechanism cannot detect any traces of data information except the characters used in the overwrite procedure. Only then can the media be considered as unclassified, and all classification labels and markings identifying the subject matter be removed. You should also ensure the computer operator checks out the computer and all related components that are to be used immediately before beginning the overwrite procedure. This is to let you know that malfunctions, which could prevent the classified information from being effectively overwritten, do not occur. During the overwriting process, all storage locations will be overwritten a minimum of three times, once with the binary digit "1," once with the binary digit "0," and once with a single numeric, alphabetic, or special character (other than "0" or "1"). The current used in overwriting must be equal to that used when the data was first recorded, but not so strong that it will damage or impair the equipment. If the storage device fails in such a manner that it cannot erase the data from the media, the media may be declassified by exposing the recording surface(s) to a permanent magnet having a field strength at the recording surface of at least 1500 oersted. Care must be taken to ensure that the entire surface is wiped at least three times by a nonuniform motion of the magnet. Care must also be taken to assure that all tracks are covered by the center of the magnet. A thin sheet of clear plastic (a 1-to-5-mill sheet) should be used to prevent any damage to the recording surfaces.

MAGNETIC TAPE AND DISKETTE DESTRUCTION

When it comes to the destruction of magnetic tape and diskettes, you will use the same techniques as hard copy material. Depending on the equipment available to you, you will shred or burn the material, depending on the classification and the type of equipment. Because of their design, some of the shredders can not be used to shred magnetic tape or diskettes. Remember to use your local standard operating procedures (SOPs) as guidance

for the destruction techniques that are used at your command.

RELEASING (SCRATCHING) MAGNETIC MEDIA

As librarian, one of your many tasks may be to release (scratch) magnetic media; that is, make the media available to the computer operator for reuse. Before you release or scratch media, there are several things you should know. First, never remove a save label from a tape, disk, or diskette without the permission of the user to whom the data on the media belongs. Well, then you might ask, how does one go about getting the user's permission? There are several ways this can be accomplished: by phone, by way of an interoffice memo, or by contacting each individual in person; but the fastest and easiest way is to distribute a copy of the release report on a weekly basis. The users can annotate the files they want released and return the report to you. At that time, you can scratch the appropriate files and make the magnetic media available for reuse.

But wait, is the file you are about to scratch the same file that is listed on the release report? Good question. Before you start removing save labels, be sure that all information written on the save label agrees with what is listed on the release report. There are times when the computer operator is in a hurry to get things rolling and may accidentally place the wrong wrap-around strap on a tape, disk pack cover on the wrong disk, or attach the wrong save label to a newly created file. By performing this check, you could avoid hours of computer rerun time. Once you have determined the file to be scratched agrees with the information on the release report, you can remove the save label.

If the file to be scratched contains classified data, be sure the media is degaussed before its release unless it is to be used again for the recording of classified data of the same security level.

Next, examine the media thoroughly to be sure it is healthy (in good physical condition). Be on the lookout for the following problems:

MAGNETIC TAPE— Look for contaminants on inside and outside of flanges, tape unevenly rewound (take note of the tape unit it was created on), cracked or warped flanges, cracks around the center hub (if made of plastic), uneven tape packing (look for ripples between the layers of tape), and broken or deteriorated locking mechanisms.

MAGNETIC DISK— Look for contaminants inside and outside of the disk pack covers, cracked or broken covers (top and bottom), and damaged or warped disk platters. Be sure the locking mechanism is functioning properly.

DISKETTES (floppy disk)—Look for contaminants, primarily dust and oily marks on the outside cover.

Next, you should look at the usage and certification labels to see whether or not the tape or disk needs to be cleaned or recertified; and if so, do it.

Finally, be sure to place (insert) a write ring in the slot provided on the back side of each scratch tape. Forward the magnetic media to the computer operations area. Do not forget to follow up on the paperwork. That is, update the library master file (or database) to reflect latest status on the media.

LIBRARY MANAGEMENT

In addition to performing library functions, you will need to consider other areas of library management. These include protection and storage of media, maintaining a proper physical environment, management of classified media and materials, magnetic media administrative duties, tape retention, and disaster/off-site backup. You will learn about these management areas in this topic.

STORAGE OF MAGNETIC MEDIA

Data is one of your installation's most valuable assets, and, as the librarian, you are responsible and accountable for its protection. You must protect it from a number of things. The data that is recorded on magnetic media must be protected from theft, unauthorized access by individuals, destruction by fire, flooding, contamination, accidental overwrite, and so on. The key words here are protection and security, not only of the media but also of the library spaces as well.

The library must be theftproof. It should be of vault-type construction, with no windows and with cypher locks (or their equivalent) on the doors. Personnel access must be closely controlled. You must follow proper procedures to ensure that material entering or leaving the library is controlled. You should be aware of the fact that security means more than the loss of data through theft or sabotage. If the user cannot depend on the data, as recorded on magnetic media and retrieved from the library, then the entire library becomes worthless. Regardless of the classification of

the data your command processes (Unclassified, Confidential, Secret, Top Secret), you must ensure that the library is secure.

Another security requirement is fire control. Smoke and fire alarm systems are necessary. Sprinkler systems that react immediately to any threat of fire area must. Insulated vaults (safes) and storage cabinets like the ones shown in figure 2-13 are extremely helpful in preventing magnetic media and paper records from being destroyed in the early moments of a fire before it can be put out. They can also help reduce the heat to which the storage media are exposed. Heat can be particularly harmful and damage the data even if the medium itself is not destroyed, because plastic melts, and metal warps.

If the storage devices are insulated, this will further protect against water damage, either from natural accidents, such as floods, the sprinkler system, or personnel putting out a fire. Some commands prefer to use an inert-gas extinguishing system, or chemical fire extinguishers rather than the conventional water sprinklers. These help to eliminate the damage and contamination that would otherwise be caused by water. Another safety feature is the lead-strip vault door hinge. The lead strip will melt at 150°F and automatically close the vault door (see figure 2-14).

LIBRARY ENVIRONMENT

The library is usually located in the same functional area as the computer room it is supporting. This is especially true aboard ship. Magnetic tape, disk, and other media must be maintained within the same environment, or the same type environment, as the

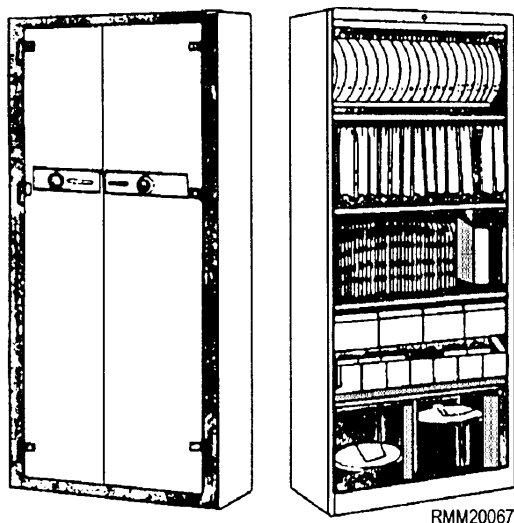

Figure 2-13.—Media storage vault and cabinet (with doors open).

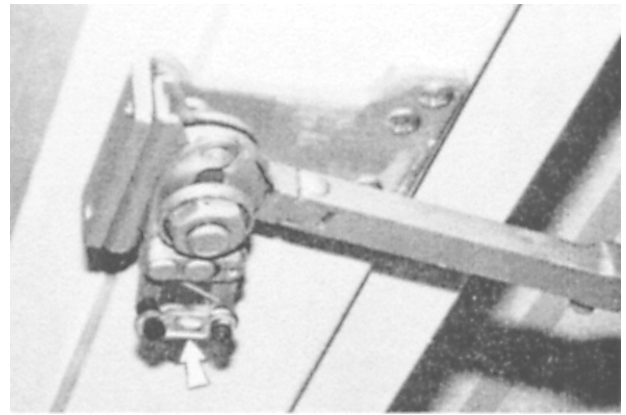

Figure 2-14.—A lead strip bolted in the vault door hinge.

computer facility. If not, the media should be placed in the proper environment for a minimum of 24 hours before using; otherwise, the operators may encounter problems using the media. Temperature and relative humidity tolerances should be maintained within specified limits. In the absence of other instructions, maintaining a 30 to 60 percent relative humidity at 70°F to 80°F is considered an acceptable environment.

In the library, especially the tape cleaning area, the elimination of dust, lint, and foreign matter on equipment is necessary for efficient operation. In short, the cleanliness of equipment, floors, and contact areas and the control of humidity and temperature are essential.

Traffic in and out of the library should be kept to a minimum. Smoking, eating, and drinking should be prohibited at all times.

The library should be vacuumed and/or cleaned with a damp mop. A dry mop, fox tail, or dust broom should never be used, as they tend to kick up more dust than they take up. Aerosols should never be used in the library environment, because the oily, dust-collecting moisture settles and eventually finds its way onto the equipment as well as the surfaces of the media.

The use of air-conditioning filters in the library should be given special attention, because fiber glass filters often fail to prevent the penetration of fine silts and tend to deposit particles of fiberglass on magnetic media.

MANAGEMENT OF CLASSIFIED MEDIA AND MATERIALS

As the media librarian, you must ensure that all classified magnetic media bear some type of external markings or labels and internal notations. The markings must be sufficient to assure that any one receiving such media will know that classified information is involved and what its specific classification category is.

The unique methods employed when handling, processing, storing, degaussing, transferring, or mailing this type of media require correspondingly unique security procedures, some of which you read about in Module 1, "Administration and Security." Additional information regarding these and other areas related to AIS security may be found in OPNAVINST 5239.1, *Automatic Data Processing Security Program*, and OPNAVINST 5510.1, *Information and Personnel Security Program Regulations*.

The rules, regulations, and procedures in the OPNAV instructions and local command instructions are there for good reason. They provide you with the information needed to protect classified materials and media, and their contents. It is up to you to carry out these procedures, without unduly complicating AIS operations.

You are probably asking yourself, as a librarian charged with the responsibility of handling classified

materials, how do I go about keeping everything uncomplicated and on track? The answer is simple: follow established command procedures, know where the materials are located, and keep track of classified media and materials at all times, whether they are in or out of the library. The keyword here is *accountability*.

Every reel of magnetic tape, disk pack, and diskette that are to be used for recording classified information should have a stick-on, pressure sensitive classification label, specifying the classification of the highest level of information ever recorded on this media. (See figure 2-15.) In addition, after recording has taken place, you must ensure that the proper save label has been placed on the face (front) side surface of the media. This label should contain the highest classification of information recorded on the media, the date the recording was performed, and other appropriate identification information required by your installation. Magnetic media that is not the property of your AIS installation, but which is on loan from another installation, (known as foreign tapes, disks, and so on), should be isolated in the library and separated according to security classification. Classified magnetic media received from other AIS installations should be degaussed before you return it, unless the sending organization specifically requests the media not be degaussed.

Before returning the degaussed media to its rightful owner, a certificate of destruction should be filled out and retained in the library. For reasons of security,

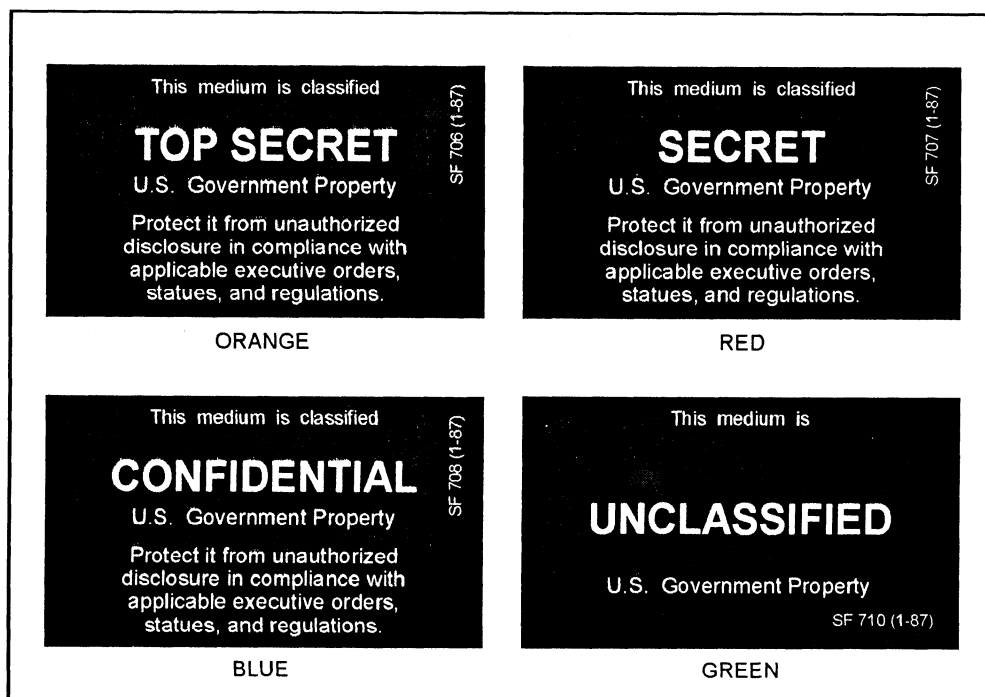

RMM20069

Figure 2-15.—Classification labels.

copies of the certificate of degaussing destruction should not accompany the media during transmittal.

Performing Security Functions

Security functions are very important in a magnetic media library, not only for classified media but also for any material. Data has value, whatever its classification or use: Top Secret, Secret, Confidential, Privacy Act, For Official Use Only, or Unclassified. Applicable security instructions and procedures must be followed. Some of the tasks include the following:

- Storing and safeguarding classified media and materials
- Maintaining security logs and library access lists
- Degaussing and/or destroying classified media and materials
- Changing lock combinations on doors, safes, and vaults

Ensure that all security procedures and measures relating to the library are understood by everyone connected with the library, especially the librarians. See that procedures are enforced. This includes controlling entrance (access) to the library spaces (both on-site and off-site storage areas), as well as providing physical and administrative controls of the media. The librarians must ensure proper security protection is provided for all magnetic media and materials in accordance with applicable security instructions and procedures. This includes issuing, receiving, shipping, declassification, destruction, and disposal.

MAGNETIC MEDIA ADMINISTRATIVE DUTIES

Attention to administrative detail is a must. It will help assure that media are properly maintained and ready for use. Control logs, pass-down log, library listings, and reports are all a part of the everyday administrative functions. Administrative duties and responsibilities include the following:

- Maintaining tape cleaning, verification, and degaussing logs
- Checking magnetic media in and out, using appropriate logs
- Making entries in tape and disk control logs
- Making entries in pass-down log

- Labeling magnetic media
- Establishing and updating current and history files
- Preparing library listings and reports for distribution

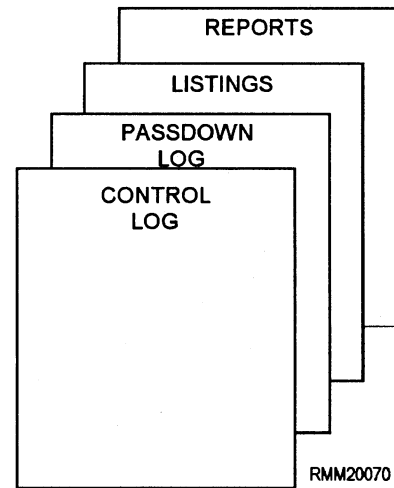

To accomplish this task requires a specially designed program that is able to read the internal label information that is stored on the magnetic media. The program extracts whatever information it needs to build a record onto the library master file (or database file). Once a record is established, you can make changes or deletions as necessary.

Most AIS installations have incorporated or are capable of installing some type of automated tape library control (ATLC) program. Various manufacturers supply these software programs for their computing systems. These programs provide an automated capability for preparing various user and management reports to assist in the operation and control of your installation's magnetic media library. These reports reflect the current status of each tape reel, disk pack, and diskette in the library. You will find that various manufacturers give different names to their library accounting programs; however, the majority of these software systems accomplish the same functions. The names may change, but the game is the same. For this chapter, we use ATLC.

A good ATLC system should be capable of providing you with the library edit and error, reel master list, application, user/programmer, media to be released, library maintenance, off-site storage, and history reports.

LIBRARY EDIT AND ERROR REPORT— This report provides you with information and error-type messages pertaining to the ATLC system transactions; those submitted, rejected, and processed.

MASTER LIST REPORT— This report provides you with information pertaining to each type of media contained in the ATLC system. This report is normally listed in identification number sequence.

APPLICATION REPORT— This report provides you with information pertaining to media assigned to any particular project (supply, payroll, and soon). This report is normally listed by project number and identification number.

USER/PROGRAMMER REPORT— This report provides you with information pertaining to media that is assigned to a particular user or programmer. It should be in user/programmer number, release date, and identification number sequence.

MEDIA TO BE RELEASED REPORT— This report provides you with information pertaining to the media that are scheduled to be released (scratched according to purge date). It is normally listed in identification number and/or in file-ID sequence.

LIBRARY MAINTENACE REPORT— This report provides you with information regarding the media itself, indicating when the media was last cleaned, when it was last stripped (magnetic tape only), and recertified. This report is normally listed by media type (tape or disk) and identification number.

OFF-SITE STORAGE REPORT— This report provides you with information pertaining to the media that are stored off-site. This report is normally listed by media type, release date, and identification number.

HISTORY REPORT— This report provides you with various information pertaining to all magnetic media classified as history files. This report should be listed in media type, release date, and identification number sequence.

All input, changes, and deletions to the ATLC systems database (master file) should be accomplished by the librarian to ensure database integrity. You should have up-to-date information on how to properly maintain the ATLC system so you can key-enter (via CRT) new records, make changes to existing records, or delete records entirely. You must also know how to use input parameters and possibly SCL parameters to produce the appropriate output products.

The main purpose of any ATLC system is to relieve you of having to maintain numerous logs and library files by hand. So, if your AIS installation has an automated library control system, take full advantage of it; otherwise, you can look forward to many, many hours of manual labor. You will also find that the number of tape and disk accountability problems will be lessened considerably under an automated system.

Using Remote Terminals

Many tape libraries use remote terminals connected to mainframes or minicomputers to help manage their library functions. The automated library control system (ALCS) is one use. Remote terminal operation will include the following tasks:

- Performing log-on/log-off procedures
- Entering proper system passwords to assure security
- Inputting data to computer
- Retrieving data from computer
- Updating library files using ALCS
- Querying/searching library files using ALCS
- Requesting library listings and reports



Ensure that all library personnel are properly trained on how to use the library's remote computer terminal. All personnel must have a good working knowledge of the features and functions of the keyboard. They must know how to properly logon to the system and how to enter their access code. They must also understand how to gain access to library files and how to input and retrieve data to and from the computer. They should know how to update and query the library's database and how to request library listings and reports. Knowing how to close out files they are

working with, and how to properly logoff the system at the end of their work day are also important parts of their job.

TAPE RETENTION

A restricted retention period has been established to prevent permanent physical damage to magnetic tapes, especially tapes that are stored for long periods of time, such as history tapes. This provides for all magnetic tapes to be cleaned, possibly certified, and repacked at prescribed time intervals. This procedure eliminates such problems as oxide sticking, debris embedment, and edge deformation caused by tape pack shifts inside the reel.

Initially, an on-site save tape retention period should be restricted to a maximum of 90 days, with only one 90-day extension. After 180 days, you should notify the user indicating that the tape should be copied (and verified) onto a recently cleaned tape, thus freeing the original tape to be tested for accuracy. The retention period for off-site tapes should initially be 180 days, with one 30-day extension.

FILE AND DISK MANAGEMENT

File and disk management are other areas where your knowledge will help users. They probably don't know the **agony of delete** or the problems sometimes caused by very large files. Think about what you have learned regarding file management. How to name files. How to cleanup files. How to back up files. When to back up files. Where and how to physically store files. How to protect files. How to organize files on disks. Let's examine some of the considerations for setting up files and file management procedures for microcomputers: naming files, disk file organization, and file backup. We will be using DOS as the operating system for the examples in this section.

Naming Files

Every newly created file must be given a file name if it is to be stored (written and given an address) on disk. When the operating system looks for a filename, it looks up the address in its "address book," the directory. The directory is maintained in a fixed location on every disk.

Every operating system will have a system for naming files. In DOS, file names have two parts. The first part, the primary file name, names the file and can be from one to eight characters in length. The second

part, called the file name extension, is optional, and can be from one to three characters. While the extension is optional, the primary part of the file name is NOT. An extension cannot name a file, it can only be used to further qualify or describe a file. If both parts are used, they must be separated by a period, for example, TELECOMM.TP7. To name a file (including its extension), you may use any combination of the following characters: the letters A through Z (upper and lower case), the numbers 0 through 9, the following special characters: \$, #, !, %, (,), -, {, }, _, and the left and right apostrophe.

Why would you want to use an extension? you might ask. Let's assume you created a file that contains all E-4 evaluations for the year 1997 and you named the file DIV-EVAL. It's a perfectly good and valid name under DOS. However, it is entirely possible you would want more than one file called DIV-EVAL, considering the years that follow. In this case, you might want to use the option of adding a file name extension. For example, you could label the 1997 evals DIV-EVAL.97, the next year's DIV-EVAL.98, the following year's DIV-EVAL.99, and so on. In this case, the years 97,98, and 99 are the extensions.

Some extensions have **special meanings** in DOS and are either created by DOS or assume the file contains a special type of program or data. For this reason, use extreme caution and avoid using file extensions defined by the program or operating system you are using. Examples of extensions assigned by DOS are as follows:

COM, EXE, SYS, BAT— File extensions such as COM(mand), Executable), SYS(tem), and BAT(ch) contain executable code. That is, the code is actually understood by the hardware when programs are run.

BAK— When opening a text file, the DOS program automatically makes a backup copy with the extension **BAK**.

BAS— BAS refers to a source program written in the BASIC language.

COB— COB refers to a source program written in COBOL.

HEX— HEX refers to a special type file where all information has been stored in HEXADECIMAL format.

Various applications software packages automatically add an extension. For example, ENABLE adds "WPF," DBASE adds "**DBF, NDX,**

FRM, and MEM,” LOTUS adds “WK1, PRN, and PIC.”

It is important to devise a naming scheme that is comfortable for you. Your command may have already addressed this area and come up with descriptive naming conventions. If so, of course, you will use those. Whatever method you use, be sure that it is indeed a method and NOT just haphazard naming of files. When working alongside the end users, be sure to pass along what you have learned. When they go to the filing cabinet, be sure they know exactly which file drawer to open and which file folder to retrieve from that drawer. Most people are familiar with organizing file folders in the drawers of a filing cabinet. You might want to use this analogy as a starting point, explaining to the users how they can organize their disk files in much the same manner. Explain how they can organize their work (files) into groups of files called **directories**.

Directories

File directories, like the folders that are filed away in drawers by category, or like the yellow pages of the phone book, provide you a way to organize and find files by category and name.

Most operating systems give you the option of creating either **single** or **multiple-file directories**, regardless of whether your system uses floppy or hard disk. Disks with only one directory are said to be of the **unstructured** or **flat type**. Disks having more than one directory are said to be **hierarchical** or **tree structured** because they contain a root directory and several subdirectories, each subdirectory containing files with common subject matter. We use the term *tree structure* because this type of directory takes on the appearance of an upside down tree with the trunk of the tree or root directory located at the top and all the branches or subdirectories located below.

Let’s assume you have a floppy disk that contains 50 files with only a main or root directory, as shown in figure 2-16. Upon displaying the directory (using the DIRectory command), you notice the files are listed in random sequence, usually in the order of their creation or when last updated. We call this an unstructured directory. Looking more closely, you realize a number of things. First, that better organization is needed. Second, that most of the files listed can be grouped together by categories: supply, 3-M, personnel, disbursing, food services, and division management. Finally, you see that there are really two types of

```

A:\DIR
Directory of A:\

FIL  NAME/EXT.      FSIZ  CR-DATE    TIME
-----
PERSROST RPT      14221  7-18-96    8:34a
SUPAUDIT DOC       983   7-18-96    11:02a
SUPUPDAT EX1      83362  7-21-96    3:05p
EIV-PRT  MON        684   7-22-96    7:27p
FOODSERV UPD      25642  7-24-96    9:52a
DIN-MENU DLY      6363   7-25-96    8:36a
DISBOFFR RPT       727   7-25-96    10:23a
3M-COORD DOC     23323  7-25-96    11:15p
SUPUPDAT EX2      1483   7-26-96    9:31a
EVALS-DU DP2     8864   7-26-96    4:05p
PERS-UPD NEW     9958   7-27-96    7:45a
PAYROLL  LST     31487  7-28-96    3:00p
SUP-INVT  EX2      4343   7-28-96    6:24p
IMMS-RPT LTR      6813   8-02-96    9:47a
DIV-NOTE  S       10421  8-03-96    1:23a
3M-AWRPT MON     17453  8-03-96    4:29a
DIV-GMT  WK4      1690   8-06-96    10:18a
FIREBILL XD       9090   8-06-96    1:00p
WOSB     XD        821   8-16-96    9:18a
ETC.
ETC.
FILE 50

50 FILE(S)  101435 bytes free
  
```

RMM20072

Figure 2-16.—Unstructured disk file directory.

categories: files that deal with user applications and those that deal strictly with division matters.

Using the tree-structured approach, you can divide your disk into smaller units by subdirectories, as shown in figure 2-17. In this example, E5 Christmas, as the primary user of these files, decided to organize her files by setting up a separate directory called E5CHRISTMAS. Within the E5CHRISTMAS directory, she set up several subdirectories. They are identified by <DIR> following the name and they have no extensions. Notice also that some files, those that relate to division matters, are included in the subdirectory along with the subdirectories that relate to user files. Because E5 Christmas uses the division files frequently, she wanted to be able to access them directly from her directory.

Subdirectories, like other files, appear as entries in the directory; however, you can’t see a listing (or a display) of all the files in all the subdirectories at one

```

A:\DP2JONES > DIR
Directory of A:\DP2JONES

FIL  NAME/EXT.      FSIZ  CR-DATE    TIME
-----
.      <DIR>          884   7-18-96    7:27p
..     <DIR>          884   7-18-96    4:06p
DIV-PRT  MON        684   7-26-96    1:23a
EVALS-DU DP2     8864   7-26-96    10:18a
DIV-NOTE  S       10421  8-03-96    1:00p
FIREBILL XD       9090   8-06-96    9:18a
WOSB     XD        821   8-08-96    11:02a
PERSONEL <DIR>          816   8-16-96    11:02a
SUPPLY   <DIR>          816   8-16-96    11:03a
DISBURSG <DIR>          816   8-16-96    11:03a
FOODSERV <DIR>          816   8-16-96    11:04a
3-M     <DIR>          816   8-16-96    11:04a

18 FILE(S)  101436 bytes free
  
```

RMM20073

Figure 2-17.—Tree-structured disk file directory.

time. Instead, you must look at each subdirectory to see what is in that one. If E5 Christmas wants to see what files are in the subdirectory SUPPLY, she would use the DOS command to change the directory name to SUPPLY and then display its directory (figure 2-18, example A).

As the number of files on a disk increases, so does the need to have a disk that is well-organized. A well-organized disk can save you a considerable amount of time and frustration in locating files. As computer specialists, we know this is true and of great importance, but to the uninformed or new user who has not been properly trained, disk management may seem very cumbersome and time consuming. Some users may not even be aware that they can organize their files on disk, and that's where you come in. How can you help users create and use a tree-structured directory? you might ask.

Whenever you format a disk, a single directory called a root directory is created. You can then instruct DOS to create or MaKe other DIRectories, using a command such as MKDIR or just plain MD. These are called subdirectories. Further, a subdirectory can have other subdirectories. Directories, regardless of their level, are given names just like any other files. DOS keeps track of each directory the same way it does your files. Using various DOS file handling commands, you can create (MKDIR or MD), change (CHDIR or CD), and remove (RMDIR or RD) directories and subdirectories. To move through the tree structure (UP or DOWN), you must issue commands that use a **path name**. A path name is a list of the directory(ies) (which might end with a file name) that DOS

must follow to find a given directory/subdirectory or file name. In example B in figure 2-18, to locate the file named DIN-MENU.DLY, the path is \CHRISTMAS\FOODSERV\DIN-MENU.DLY.

Once you have grouped related files into a subdirectory, you can act on them as a unit. The DOS file-handling commands can be applied to an entire subdirectory of files in a single stroke. For example, you can issue commands to copy, print, or delete all the files in a subdirectory as easily as you can for a single file. Other files on the same disk, but in different directories go unused and undisturbed. Subdirectories are especially helpful when working with hard disks because of their large storage capacities.

To learn more about DOS directory structures and commands, read the DOS reference guide that accompanies the DOS software.

Backing Up Files

You have heard it before, and you are going to hear it again here: BACKUP your programs and data files. If you don't, you will eventually lose all or part of your data, and the only person you can blame is yourself.

Data can be lost or damaged in a number of ways. Common causes of data loss are power surges and drops, power failures, and user errors. User errors top the list. Less common but potentially disastrous are fire, theft, vandalism, and natural disasters.

How often have you come close to erasing a file or formatting a floppy or hard disk by accident? Probably more times than you care to admit. No matter how many precautions you take, you can't prevent all the potential ways data can be lost. You can certainly reduce their adverse effects by backing up your files on a regular basis.

When working with data files, you will want to back them up at least on a daily basis either to tape, diskette, or to another hard disk. For our example, we will use two diskettes. A technique referred to as the odd/even backup uses two diskettes. Label one diskette as odd and the other as even. When you make your backups, use the odd diskette on odd days, and use the even diskette on even days. This pays off when you find that errors were inadvertently made to a file the day before, and you backed-up that file onto your backup diskette. With this system, you can go back 2 days if needed.

No matter how many backups you make (two, three, or one for everyday of the week) or what method you use to make them, they are worthless if they are

```

EXAMPLE: A
A:\SUPPLY>DIR
      Directory of A:\CHRISTMAS\SUPPLY

.                <DIR>       7-18-96   11:00a
..               <DIR>       7-18-96   11:00a
SUPAUDIT  DOC      983       7-18-96   11:02a
SUPUPDAT  EX1     8362      7-21-96   9:06p
SUPUPDAT  EX2     1483      7-28-96   9:31a
SUP-INVT  EX2     4348      7-28-96   6:24p

      6 FILES(S)  bytes free

EXAMPLE: B
A:\FOODSERV>DIR
      Directory of A:\CHRISTMAS\FOODSERV

.                <DIR>       7-24-96   9:50a
..               <DIR>       7-24-96   9:50a
FOODSERV  UPD     26642     7-24-96   9:52a
DIN-MENU  DLY     6369      7-26-96   8:36a

      4 FILES(S)  101436 bytes free

```

RMM20074

Figure 2-18.—Examples of files in subdirectories.

destroyed along with your microcomputer. You need to make multiple backups and store a set in a different area away from your working area or, at a minimum, in a data safe. This will require some extra effort by you or the user, but it will more than pay for itself should you ever experience a data loss.

Care, Handling, and Protection of Diskettes

As communications specialists, we know how sensitive diskettes are when it comes to rough handling, extreme heat and cold, high and low humidity, static electricity, and contaminants, such as dirt, dust, liquids, and grease. Unfortunately, many end users do not. They may leave their diskettes lying around out of their protective envelopes, expose them to direct sunlight, store them next to an electric pencil sharpener, and so on. It will be your job to explain and demonstrate to new users how to properly manage and maintain their diskettes as well as other types of magnetic media.

Because diskette mistreatment is usually fatal to data, it is important to have procedures to help the end user better understand how to care for, handle, and protect diskettes. They must be made aware that once a diskette is damaged, there's little chance of retrieving the data. If you were to calculate the value of a single diskette in terms of the data stored on it and the hours it took to input the data, then a \$2 diskette might well be worth several thousands of dollars. If you can make the end users understand this, then maybe they will treat diskettes more carefully. Go over the fundamentals on how to care for, handle, and protect diskettes. Explain how to properly load a diskette into a drive.

CARING AND HANDLING OF DISKETTES.— We know how important it is to keep diskettes away from cigarette smoke, greasy foods, and beverages that might be spilled on them, but what about the end users? Do they know the negative effects these substances can have on their computer, the media, or their work? Probably not, and that's where you come in.

Never bend or fold diskettes. The diskette drive only accepts a diskette that is absolutely flat. If it is bent or crinkled, it may cause severe damage to the read/write heads as well as make the data unretrievable.

When preparing an external file label, never use a pencil or ball-point pen if the label is already affixed to the diskette's jacket. Instead, use a felt tip marker and be sure to press lightly. Unless labels are scarce, you would do well to inform the user it is far better to prepare a new label before placing it on the diskette. Then, using extreme care, remove any label on the diskette

and place the new one on. Never stack labels one on top of the other on a diskette. It may cause problems when you insert the diskette into the drive.

Show end users how to handle and properly use diskettes. To be used, a diskette must be inserted into a disk drive. Sounds simple enough; however, if you were to measure a 5.25-inch diskette, you would find that each side measures 5.25 inches—it is perfectly square. To the end users, inserting a diskette into a drive could become a bit of a problem with eight possible ways to insert it. We know a diskette goes into a drive correctly in only one way. If the disk drive is the horizontal type, insert the diskette with the label facing up and the recording window toward the drive door, as shown in figure 2-19. Normally, if the disk drive is the vertical type, hold the diskette with the label facing left while inserting it with the recording window toward the drive door. Once the diskette is properly inserted, close the drive door by lowering the drive latch. This positions the read/write heads and locks the diskette in place. This locking step is necessary; otherwise, the system will not be able to access the diskette in the drive.

PROTECTION OF DISKETTES.— How many times have you read or heard the following “Whenever diskettes are not being used, they should be stored in a protective envelope”; or “Whenever a diskette is removed from its protective envelope, never touch any of the diskette's exposed parts”; a thousand times maybe? The same may not be true of individuals who have just been introduced to the world of computers. It will be your job to assist and educate these new users through OJT in their working environment.

Temperature and humidity are also important. Never leave diskettes in direct sunlight or in areas where humidity is extremely high or low. High humidity can cause moisture to form on the diskette's surface or possibly warp the diskette's protective jacket. Low humidity makes conditions ideal for the buildup of static electricity, which you can transfer or discharge to a diskette, thereby destroying the data. Diskettes are designed to withstand temperatures from 50 to 125 degrees Fahrenheit, 10 to 52 degrees Celsius, and a

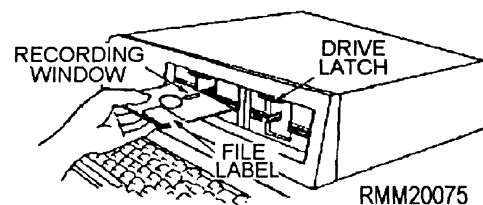

Figure 2-19.—Inserting a diskette properly.

relative humidity of 8 to 80 percent. However, we in the computer community try to keep all magnetic media within a temperature range of 60 to 80 degrees Fahrenheit, and a relative humidity of 30 to 60 percent. Generally speaking, a temperature and humidity in which you are comfortable will also be comfortable for diskettes.

The users must also be made aware that they are to keep all types of magnetic media, including diskettes, at least **one foot** away from anything that generates a magnetic field. This includes magnets of any kind, such as those found in telephones, stereo speakers, and paper clip dispensers, as well as magnets on copyholders and inside of printers. It also includes motors, such as those found in portable fans and floor buffers and polishers.

System Care and Operator/User Maintenance

The fact that microcomputer systems are small and out in the workspaces doesn't mean they don't need operator maintenance. They do. Dirt accumulates on diskettes, disk drives, printers, display screens, and keyboards. Static electricity can also be a major problem, especially in areas where humidity is low.

Keep your system as clean as possible. One way to do this is by using dust covers. This, of course, only protects the system when it is not in use. You will still need to clean the components on a regular basis.

Clean the floppy disk drive heads with a head cleaning diskette. It is easy to do. Read the directions that come with the head cleaning kit. They may have you put fluid on the cleaning diskette. Then you insert the cleaning diskette in the drive and activate (lower) the heads for a few seconds. This helps reduce service calls, and you are less likely to lose data. How often you will need to do this will depend on how much the system is used and whether the area is very dusty and smokey. Some floppy disk drive manufacturers recommend cleaning the heads no more than twice a year. As your subject matter experts (SMEs), we recommend cleaning the heads after 40 to 50 hours of actual use.

To clean keyboards, you can use specially angled swabs with cleaning solution, and/or a portable vacuum that has special attachments to reach between keys. Vacuums of this type usually have dual-filter systems to keep from blowing dust and dirt back into the room. Ultra soft, thin bristle brushes are also available for cleaning keyboards. We do not recommend you use

low-pressure air or canned air (a harmless gas under pressure), as this cleaning method has a tendency to blow dust and dirt into cracks, crevices, and electrical components that could eventually cause you problems.

The display screen needs routine cleaning. A dirty screen can be hard to read and may contribute to headaches and fatigue. You will be able to see the dirt, dust, and smoke buildup on the screen. The dust can cause static electricity that may result in lost data. You may use a liquid video spray cleaner, but do NOT spray it on the screen. Spray it on a lint-free nonabrasive cloth. A **word of caution**. Many commercial cleaning solvents contain alcohol and other flammable agents. If your display screen is on (energized) when it is cleaned with one of these flammable fluids, combustion can occur. An energized display screen can discharge quite a bit of static electricity—a sufficient amount to ignite alcohol. So, if you intend to clean your screen, turn the monitor **OFF** first. Also available are wet/dry towelettes. These are convenient to use because the cleaning solution is normally premeasured and they come in individual packets. To reduce static electricity, special antistatic sprays are available, or you can use antistatic pads or mats. Some cleaning solutions include antistatic chemicals. An antistatic filter for the display screen is another way to reduce static buildup. Antistatic dust covers may also help when the system is not being used.

Printers create their own bits of paper and dust. To clean the printer, use a vacuum designed to clean computer components. These vacuums are usually portable, have a dual filtering system, and can clean in small, hard to get places. Cleaning solutions and specially shaped brushes are available for cleaning platens. For cleaning the print heads, you can feed a specially designed print sheet cleaner through the printer just like you feed continuous-form paper. Laser printers have special cleaning requirements. You use dry lint-free clothes to wipe any residue of surfaces and a cleaning brush to clean the antistatic teeth.

Operator/user maintenance is important for effective operation of computer systems. It helps prevent data loss and will increase the life of the computer system and its components. Establish a schedule for routine operator/user maintenance.

Loading and Unloading Tapes

When you are loading or unloading (mounting or dismounting) a magnetic tape, look for tapes with irregular windings and reel warpage. You will see that as tape is wound on a reel, it is normal for some of its edges to protrude slightly. These irregularities usually result from high-speed rewinding. The terrific speed at which tape moves during a high-speed rewind produces the slightly irregular winding caused by air being trapped between adjacent layers of tape. This, in itself, will not cause improper operation of the tape, but it does require you to use good judgment and extreme care when handling tapes.

MOUNTING A TAPE.— When you mount a tape, make sure the tape unit is not being used for another job. Check to make sure you are mounting the correct reel of tape according to job requirements. Tapes have external labels that identify the data or programs on them. Remember, if the reel of tape is an input, be sure the file protection ring is removed. If the tape is an output, be sure a file protection ring is inserted. Then proceed to mount the tape. Have one of the more senior operators on the system show you how to perform this operation because mounting a tape and depressing the proper keys/buttons differ from one system to another. Basically, you will place the reel on a hub and lock the reel in place. Then you thread the tape through the read/write head assembly onto the machine take-up reel (unless the tape unit is a self-loading tape unit). Once the tape is properly loaded, the ready light comes on.

If the tape is not properly seated on the tape unit's hub during use, it will wobble or appear to be warped. If the file protection ring is not completely inserted, this, too, can produce the same effect. In either case, the reel behaves like it is warped, and upon rewinding, the edges of the tape can become badly damaged.

Self-Loading Tapes.— The use of self-loading tapes makes tape loading much easier. Self-loading tape units eliminate the need for you to manually thread a tape between the read/write head assembly onto the machine take-up reel. All you need to do is to mount (place) the reel of input or output tape on the file reel hub and allow a small strip of tape to extend from the reel (anywhere from 2 to 6 inches, depending on the type of

tape unit). Then, by depressing the proper control panel keys/buttons in the appropriate sequence, the tape unit automatically threads the tape by using a vacuum to pull the tape into the vacuum column past the read/write head assembly onto the machine take-up reel and advances to the load-point (BOT) marker.

Tape Cartridges.—Tape cartridges are even easier to load. Tape cartridges consist of a reel of tape and a take-up reel enclosed in a protective case similar to the cassette tapes you are familiar with, only larger. Here, you simply mount the entire tape cartridge on the tape unit and depress the proper keys/buttons. The tape automatically loads. Your hands never come in contact with the tape. The cartridge type of tape unit also works under vacuum control and threads the tape in the same manner as self-loading tape units.

DISMOUNTING A TAPE.— When a job finishes using a tape, the tape is normally rewound and unloaded automatically. At that time, the ready light goes off. This is an indication to you that the tape can be dismounted and placed in its proper storage rack or returned to the media library.

LABELING A TAPE.— In some installations, you may be required to prepare the external tape label for an output tape file. On it, you will indicate such information as the following:

- The tape unit number (or drive number) where the tape file was initially created
- The date of creation
- The job name or number
- The identification or volume number
- The tape usage data and other pertinent information

STORING TAPES.— When not being used, tape reels should be properly supported. The plastic canister or tape strap is designed to fully support the reel. A tape reel that is supported in any other manner may become warped.

LOADING AND UNLOADING PAPER FORMS.— Many printers have a soundproof cover that you must raise to gain access to the forms tractors and other manual controls. By moving the print-unit release lever toward you (figure 2-20, frame A), you unlock the print unit assembly. This allows you to swing the unit out to the side and gain access to the upper and lower forms tractors (figure 2-20, frame B). You then open all four tractors to unload or load paper forms.

Unloading Forms.— To remove forms already in the printer, tear off the form at the end of the report and let the unused portion fall back into the box. The printed portion will normally follow on down into the printer's stacker. Now, you are ready to insert (load) a new form.

Loading Forms.— Quite often, you will find yourself having to load a form of a different width. To do this you will have to adjust the tractors. When adjusting the tractors, it is a good practice (and sometimes a command policy) to keep the left-hand tractors in one permanent location. In this way, both you and the programmer always know where print position 1 will print on any given form. To adjust the

right-hand tractors, you must use the tension control (figure 2-21). This allows you to move the tractors to the desired location. As you become more experienced, you will know where to position the tractors for all standard form widths. You then place the form over the sprockets and close the tractors.

Now that the forms are in place, you apply the proper amount of tension to the paper. To do this, use the tension control (figure 2-21). By depressing the left button, you move the right-hand tractor closer to the left-hand tractor, thereby decreasing the amount of tension to the paper. By depressing the right button, you move the right-hand tractor farther away from the left-hand tractor, thereby increasing the amount of tension to the paper. If there is not enough tension, the forms tend to feed improperly, and they may tear. If too much tension is applied, the tractor latching pins tend to rip out the sprocket holes in the form and may cause the forms' tractors to open. Once the proper tension is applied, you can proceed to align the forms so that the information will print in the correct location, both vertically and horizontally.

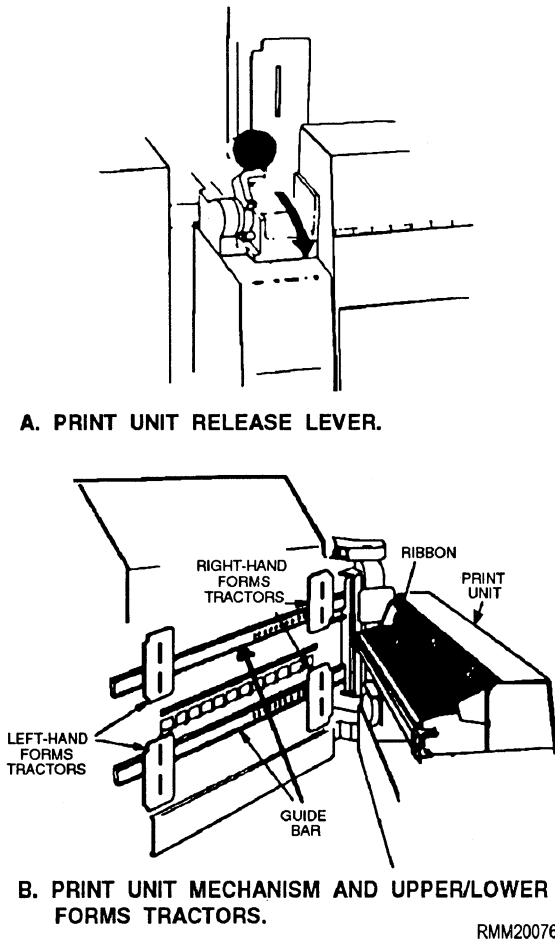

Figure 2-20.—Open the print unit to access the print unit and forms tractors.

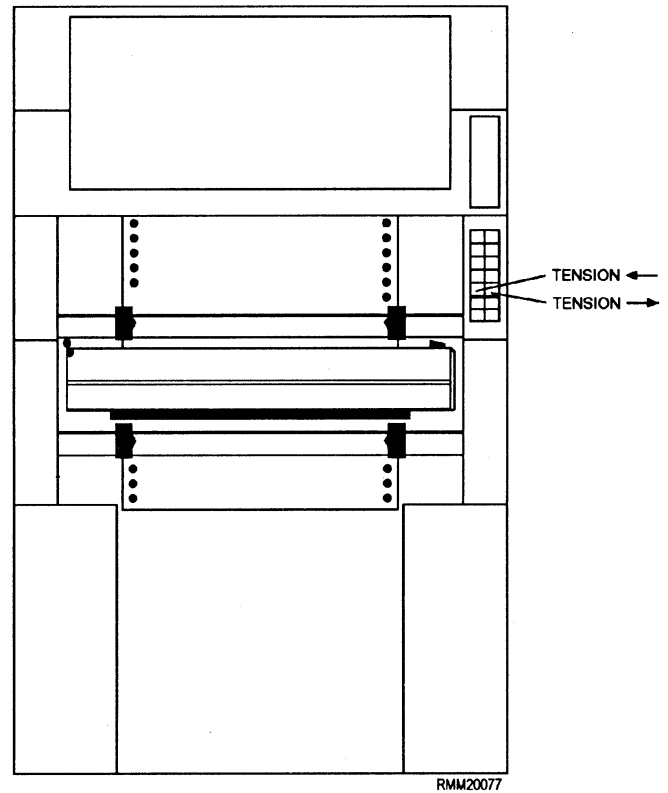

Figure 2-21.—Tractor and tension control adjustments.

Aligning Forms.— Most high-speed impact printers are designed with a ribbon shield. This ribbon shield protects the form from coming into contact with the printer ribbon, thus eliminating ink smears. It also serves as a print line indicator, which we use to align the form. The ribbon shield swings in front of the form (figure 2-22, frame A). Once the ribbon shield is in position, it can be used as illustrated in figure 2-22, frame B, to help in the adjustment of the form. Use the horizontal adjustment control shown in figure 2-23, to slide the entire print mechanism to the left or right. When the left margin of the form is even with the first ruled line on the ribbon shield print line indicator (figure 2-22, frame B), release the horizontal adjustment button. At this point, the horizontal printing is accurate to within one print position. Use the horizontal adjustment button (figure 2-23) for any additional fine horizontal adjustments that may be necessary. This

control is especially useful when working with preprinted forms, such as your LES statement. Now that the form is positioned horizontally, you can make the necessary vertical adjustments.

Again, using the ribbon shield print line indicator as a guide, you can move the form up or down one line at a time until the form is vertically aligned by pushing the line feed button. Use the vertical print adjustment button (figure 2-23) for any additional fine vertical adjustments to align the print line to its proper position. Now that the form is vertically adjusted, close the print mechanism and lock it into place with the print-unit release lever.

Print forms not only vary in size but in thickness as well. For this reason, you will have to adjust the printer to accommodate for thickness differences. To do this, you move the form thickness control knob (figure 2-23) either left or right. This will move the print unit mechanism closer to or farther away from the print hammers, thereby giving the forms sufficient clearance to pass between these two components. The paper

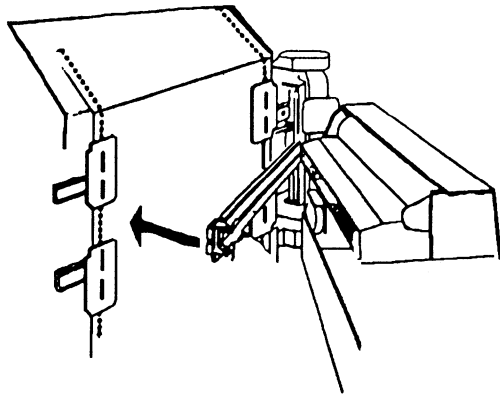

A. RIBBON SHIELD RELEASED.

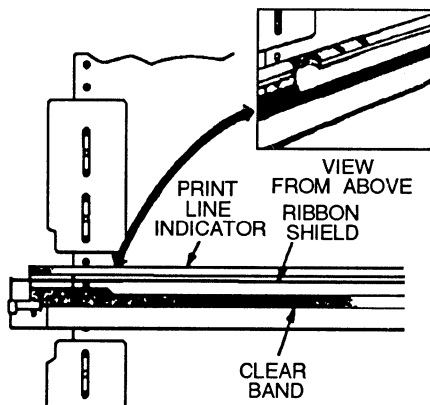

B. USING RIBBON SHIELD FOR INITIAL HORIZONTAL ALIGNMENT.

RMM20078

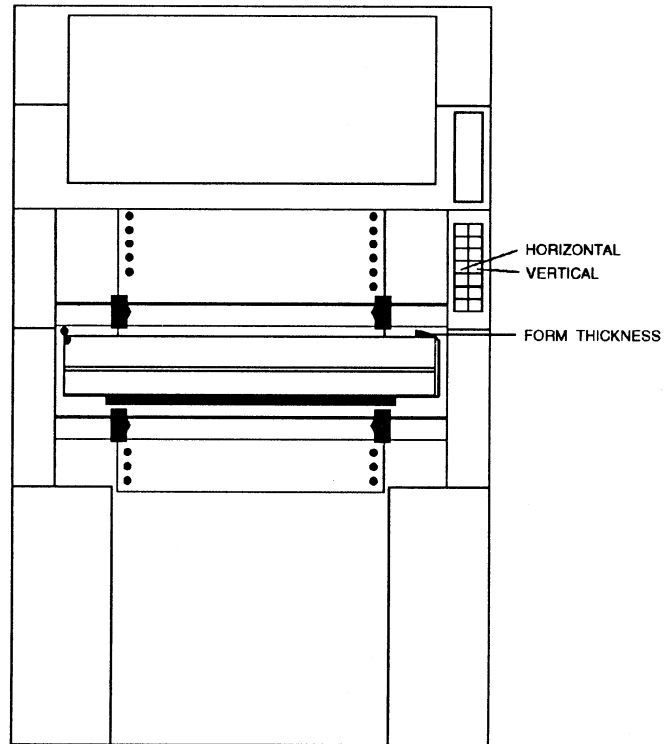

RMM20079

Figure 2-23.—Vertical and horizontal alignment controls used to adjust printer paper.

Figure 2-22.—Using the ribbon shield for alignment.

thickness control knob has a direct effect on the printer's phasing (which has to do with the quality of the printed character). For this reason, it is important that this be set properly.

Once you become familiar with the various buttons, levers, and controls of anyone of the many printers you may be working on, you will quickly find that most forms are relatively easy to align. For those that are not, such as preprinted forms, often the programmer will assist you by printing out form alignment characters to allow for proper alignment before the actual printing of the job.

OPERATOR MAINTENANCE.— Although a maintenance contract is usually carried on the printer, you are still responsible for part of the routine maintenance. Keep the exterior and interior of the machine clean using a vacuum cleaner wherever possible. Check the print mechanism for carbon and ink buildup that accumulates and eventually causes problems. And most importantly of all, change the printer ribbon as often as needed. When the print starts to fade and adjustments to the form's thickness and print density controls do not seem to help, then it is time to change the printer ribbon.

It is a good practice to get into the habit of performing a test print before starting a job, especially if the job is a lengthy one. A test print is a routine designed to show you whether the printer is functioning properly: that each and every character is clear and sharp (not chopped or halved), that all characters are uniform throughout the entire print line (not wavy), and that all print hammers are firing properly.

You should now have a basic understanding of, how to remove, load, and align forms in the printer; setup the required print controls; be able to respond to the various machine indicators; and perform routine operator maintenance functions.

Reduce File Fragmentation

File fragmentation occurs when you delete a file, leaving, basically, a hole in the information on the hard disk, or when you add information to an existing file when there is no contiguous space left next to the file. To correct fragmentation, you can make a backup, reformat the hard disk, and restore your files. You can also run a software program referred to as a defragmenter to reorganize the files so the data in each file is contiguous.

Troubleshooting and Isolating Problems

Problems will range from simple to disastrous. The printer may not be printing because it is out of paper. The disk drive may not be reading because the drive latch is not closed. The printer maybe printing garbage because the incorrect printer definition is used. The hard drive may be having excessive read errors. The problems may be operator/user errors, software problems, or hardware malfunctions. Knowing which is sometimes easy. Under other conditions, it may be difficult to determine the source of the problem.

TROUBLESHOOTING.— Learn about common problems. For example, what does it mean if the monitor screen goes blank? Is the problem a simple one, such as the monitor has an automatic function that turns off the screen when it hasn't been used in a specified amount of time? Pressing any key will reactivate the screen. Or, have the brightness or contrast thumbwheels been turned, causing the screen to look blank? A turn of a thumbwheel may bring the monitor screen back to light. Has a cable become disconnected? Has the power been turned off? Is the monitor or power strip unplugged? Or, is the power supply no longer working? Has the operator hit a combination of keys by mistake that has caused the screen to go blank except for the status lines? Look at the status lines to see if they provide information. Whatever the symptoms, look first for simple logical answers. Check all cable and outlet connections. Check to see that each component of the system is plugged in properly. Check to see that the proper options are selected. For example, on the printer, is it in a ready status? Are the proper dip switches set? Is the printer out of paper? Is the correct mode of operation selected, either through the buttons on the printer or through software? If the software and hardware allow using several printers, is the correct one selected, and are any manual selections made when a switch box is used?

We could go on and on with examples. The point is, **learn from experience.** Keep a list of symptoms, probable causes, and ways you can use to trace a problem to its cause. This will help you to diagnose and troubleshoot problems. You will find users tend to make the same mistakes over and over, especially while learning. Help them by telling them about common problems, the reasons for the problems, and ways to avoid having them happen to them.

You will soon learn the common errors, keep a mental list of the sequence you use to start isolating a problem. You may want to develop a checklist. For

example, look at the list in table 2-1. These area few examples to get you thinking about problems. Look at the condition and try to determine possible causes. Look in the documentation; it usually has a section that lists conditions and possible causes. Ask the users what program they are using. Ask the users what keys they depressed and in what sequence. Ask what they were trying to do. Always check for error messages. Check any status information on the screen. You might want to develop a separate list for each component or for each software package. You might add to the lists in the documentation. Diagnostic routines can also help you find problems.

DIAGNOSTIC ROUTINES.— Most microcomputer systems come with online diagnostic routines. These are tests you run from the keyboard. They are in addition to the diagnostic tests the system automatically runs when you turn it on. Your system will probably provide a disk read test, a keyboard test, memory tests, and a power-up test. The diagnostic program will tell you what commands to use to perform each test, what to look for, and how to stop each test.

A major hardware failure could prevent the system from being able to display error messages on the display screen. Should this happen, your microcomputer system unit may have diagnostic light-emitting diodes (indicator lights) to help isolate the problem. Follow the instructions in the owner/user manuals.

Table 2-1.—Checklist for Identifying Problems

- | |
|---|
| <ul style="list-style-type: none">___ Any error messages (if yes, look them up in troubleshooting section of manual)___ Computer plugged in___ Cables properly connected___ All components turned on___ Software properly loaded___ Correct floppy disks in the proper drives___ Correct directory being used___ File name entered correctly___ Monitor displaying properly (if not, is the brightness turned down too far?)___ Cursor keys working properly (if not, is a key like the NumLock key depressed, preventing the use of the cursor keys on the numeric keypad?) |
|---|

SUMMARY

In this chapter on computer center operations, we covered trouble reports, computer system output, environmental conditions, console operations, virus protection software, AIS requests, and the media library. This is but a sampling of what will be expected of you as you enter the computer center. You will build on this foundation with the skills you have and those you will learn.

DATA MANAGEMENT

Upon completing this chapter, you should be able to do the following:

- *Explain how to convert, process, transfer, and verify data files.*
 - *Describe how to input and manipulate data on a computer system.*
 - *Calculate storage and memory requirements for computer systems and data.*
 - *Explain how to perform software configurations and how to install and upgrade software.*
 - *Review I/O file specifications and determine system I/O requirements.*
 - *Explain how to analyze the requirements, review the structure, identify the problems and change the structures of databases.*
-

Data management incorporates many aspects of data manipulation and inputting, calculating storage and memory requirements, and computer software. You will need to know how to install applications software so it works and be familiar with all types of productivity software. Database management techniques will aid you in understanding how databases are analyzed, how to review and change structures, and how to identify problems.

DATA ADMINISTRATION

Data administration is an ongoing concern of management. Data administration encompasses all the technical and management duties required for converting, processing, transferring, verifying, and inputting data. Over the years, data resources in the Navy have grown in size and complexity. It is apparent that not all of the data problems within the Navy are resolved with the use of software. Some are taken care of with hard work.

DATA MANAGEMENT

Data management programs or routines are concerned with reading and writing data, locating data files, controlling I/O devices, handling I/O errors and requests, and providing space on output media for new files. In short, data management routines oversee the

locating, accessing, outputting, and maintenance of data files. Can you imagine yourself trying to keep track of the location of all data files, which disk pack each is on, and which disk pack is mounted on which online disk drive. To try to do this would be overwhelming. Thanks to data management routines, you are relieved of this responsibility.

The converting, transferring, and verifying of data files is left up to the operator to perform. All of these processes are completed by the use of application utility programs. The transferring and verifying of data files is accomplished by using a copy utility. Data file conversion is accomplished by a utility of the software program being used, such as converting a WordPerfect® file into a Microsoft® Word file.

There are several different ways to accomplish the inputting of data into the system. The oldest technique is data entry, keying the data off of source documents straight into the system. The most common ways are inputting the data from a tape or disk file. These files are produced from another job or from another installation, such as status of supply parts.

Once the data is inputted into the computer system, we have the capability of manipulating the data by copying, appending, deleting, and editing it. Copying and appending are used primarily for manipulating

entire data files, while deleting and editing are used for individual records in a data file.

COMPUTER SYSTEM SOFTWARE

Up to now, we have been discussing computer hardware (the computer and its peripheral devices) and the manner in which these devices work and are able to talk (communicate) with each other. But what about this thing called software? Do we really need it? We most certainly do! Software plays a major role in data processing; for without software, we could not direct the computer to perform simple addition. It's the software that makes everything happen. Or, putting it another way, it brings the computer to life. At this point, we briefly describe the general types of software used in computers.

Software can be defined as a set of computer programs, procedures, and associated documentation concerned with the operation of a data processing system. Basically, there are two types of software: systems software and applications software.

SYSTEMS SOFTWARE

Systems software, often referred to as *systems programs*, consists of supervisory and support modules (programs) designed to coordinate the capabilities of the computer itself. These include programs such as operating systems, assemblers, debug routines, text editors, compilers, library maintenance routines, utilities, linkage editors, and I/O drivers.

Operating Systems

An operating system is a collection of many programs used by the computer to manage and control its own resources and operations. These programs control the execution of other programs. They schedule, assign resources, monitor, and control the work of the computer, allowing it to carry out tasks independently of most human intervention.

Assemblers and Compilers

Both assemblers and compilers are language translators. They are usually designed for specific machines and specific languages. They translate computer programs written in assembly language into machine language. A language translator for an assembly language is called an *assembler program*. Most high-level language translators are called *compiler programs*. These translators are designed to

convert the artificial languages used by programmers, such as COBOL or FORTRAN, into a machine-usable code after it is entered into the computer.

Utilities

Utilities are programs or routines that have general application. They may be separate programs or they may be routines or programs included with the operating system to further aid the user by performing standard functions. Sort, merge, and copy programs are typical examples. Other examples are text editors to allow programmers to enter, add, delete, or change program statements; linkage editors to put together compiled programs and routines; and debug routines to help programmers find errors.

APPLICATIONS SOFTWARE

Applications software consists of programs designed to solve specific classes or types of problems. For example, word processing programs help us prepare correspondence, instructions, messages, and so on. Spreadsheet programs enable us to store and manipulate numbers in numerical tables. Database programs enable us to store and retrieve large amounts of data in various report formats. Some software is ready to use and may be purchased from retail stores and government contracts. This software is called *off-the-shelf software* (COTS). If COTS is not available to solve Navywide or individual user problems, the Navy may write its own programs. Some programs are designed and written by one of the Navy's central design agencies and distributed to AIS installations for use. If no Navy-developed software will solve an individual problem, you or your automated information system (AIS) installation may write a program in one of the many programming languages.

PROGRAMMING LANGUAGES

Almost any type of application you can think of can be programmed in one or more of the many programming languages. Just as we humans speak in many different languages, computers also speak (use) many different languages. We can divide programming languages into three categories: machine languages, assembly languages, and high-level languages.

Machine Languages

A machine language consists of a combination of 0s and 1s that is used to indicate OFF and ON states of

electricity. All data and instructions are represented (written) in a binary form. This is the ONLY form the computer is able to understand. Each computer has its own machine language; therefore, a program written for one computer type cannot be transferred to another type of computer system. Writing programs in machine language code is time-consuming and requires the programmer to specify each operation code and the specific location for each piece of data and each instruction.

Assembly Languages

We use assembly languages to avoid having to code directly into machine code (0s and 1s). Assembly languages use symbolic codes called *mnemonics* to represent operations. For example, the letter *A* could be used for add, and the letters *ST* could be used for store. Although assembly languages are more user-oriented than machine languages, they are still quite complex to work with as a programmer. Assembly languages are generally used by systems programmers to design and maintain operating systems and other systems software where speed of operation and conserving storage are more important than programmer time.

High-Level Languages

A whole host of high-level programming languages have been developed to solve one particular class of problems or another. High-level languages were developed to allow you, as a programmer, to work in a language that is close to English or mathematical notation, thus improving overall efficiency and simplifying the communications process between you and the computer. These high-level languages allow us to be more concerned with the problems to be solved rather than with the details of computer operation. Examples of high-level languages include COBOL, FORTRAN, BASIC, Pascal, Ada, and C++.

COBOL.— COBOL was developed for business applications. It uses everyday English-like statements and is good for handling large data files. COBOL is the acronym for COMmon Business-Oriented Language.

FORTRAN.— FORTRAN was developed for mathematical and scientific work. It is used by engineers, scientists, statisticians, and others in areas where mathematical operations are most important. FORTRAN is the acronym for FORMula TRANslator.

BASIC.— BASIC was designed as a teaching language to help beginning programmers write

programs. Therefore, it is a general-purpose, introductory language that is fairly easy to learn and to use. With the increase in the use of microcomputers, BASIC has regained popularity and is available on most microcomputer systems. BASIC is the acronym for Beginner's All-Purpose Symbolic Instruction Code.

PASCAL.— Pascal is a language designed to teach programming. It is fairly easy to learn; yet it is a more powerful language than BASIC. Although Pascal is not yet a standardized language, it is still used rather extensively on microcomputers. It has greater programming capabilities on small computers than are possible with BASIC. It is used by many colleges and universities. It is named after Blaise Pascal, a mathematician and the inventor of the first mechanical adding machine.

ADA.— Ada is a modern, general-purpose language designed with the professional programmer in mind. It has many unique features to aid in the implementation of large-scale applications and real-time systems. Its development was initiated by the U.S. Department of Defense (DOD). It is named to honor the achievements of Ada Augusta Byron, Countess of Lovelace, who was a supporter of and collaborator with Charles Babbage, the first person to propose the concept of the modern computer. She suggested using the binary system of storage instead of the decimal system and developed the concept of a loop to execute repetitive instructions. Babbage is known as the father of the computer, and Ada Lovelace is considered the first programmer.

C++.— C++ is a general-purpose language that works well with microcomputers. It is useful for writing both operating systems and database programs. The programs are portable, which allows them to be run without change on a variety of computers.

INSTALLING THE SOFTWARE

Depending on the needs of the users, the software will vary from command to command. But one thing is for sure, your system will have a disk operating system to make the whole thing work. Beyond that, you may have users who run only wordprocessing, or only database management applications. Maybe they use graphics and do desktop publishing. Maybe all their applications are accounting, and they rely primarily on spreadsheet programs and specialized accounting type programs. Some may even be writing their own programs in languages such as PASCAL, BASIC, or COBOL. It may be your job to help users install, learn,

and effectively use one or more software packages or programs. It may be your job to develop specialized programs or routines for your installation or for users in their own work spaces. In the following sections, we will discuss installation and use of a few of the general types of software we commonly associate with microcomputers.

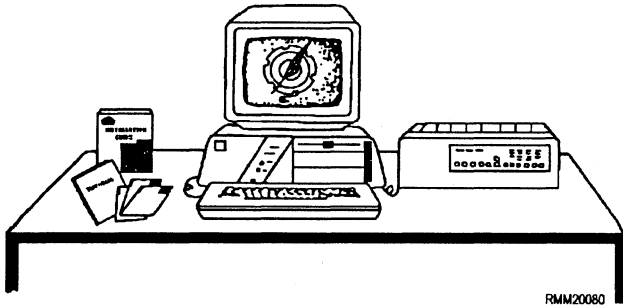

Operating System

The operating system will be the first program you will need to know about because you must install it before other programs. It manages the operation of the system.

If the system has a hard (fixed) disk, you will install the operating system onto it. The first step will be to partition the hard disk; that is, identify the hard disk to the operating system and create a partition for the operating system. Partitioning is the process of dividing the hard disk into smaller drives, which will allow you to use different operating systems, such as DOS or UNIX. Next, you will format the hard disk, prepare it so it can be used. The operating system will ask a question similar to, "Are you sure you want to format the hard drive?" before it proceeds with the format. Then, copy the operating system files from the distribution disks onto the disk. You must follow the steps in the owner/user manual. It may tell you to use a setup command that will lead you through the process from the display screen. Once it is installed, everytime you turn on the system, the operating system will load from this partition.

If the system has only floppy disk drives, you will make copies of the distribution disks onto new diskettes. If the new diskettes are not formatted, you can use a command (such as DISKCOPY) that will format and copy. Again, follow the instructions from the startup or getting started section of the owner/user manual. If there is a setup command, use it to lead you through the process. Be sure to prepare external labels with the name of the operating system. Write the serial number if there is one, and write WORKING COPY. Be

sure you use a felt tip pen if you are writing on a label already attached to the diskette.

Once you have the operating system copied and installed, put the original distribution disks in a safe place. Now, you are ready to use the computer; or are you? Chances are you will need more than the operating system. The operating system is great. It has many useful commands like COPY, DELETE, FORMAT, BACKUP, and soon. It will even have an editor, usually a line editor, that allows you to create files and edit them line byline. However, its primary jobs are to manage the system and its resources (disks, printers, and soon), and to help you communicate with the computer to use other programs (applications software).

User/Applications Software

When you install a user/application software package on a system, you need to provide the software with information about your microcomputer configuration. Because there are so many different software packages and programs available and each one has different requirements, we will not go into a lot of detail. Remember, refer to the documentation, it should provide what you need to know. Many of the manuals lead you through step-by-step. The following example should give you a good idea of what is involved. We have selected a wordprocessing program for our example because most installations will have a wordprocessing package.

BACK UP DISTRIBUTION (ORIGINAL/MASTER) DISKETTES.— The first thing you should do is copy the files from the distribution diskettes. Each software package may have several diskettes. If you have a hard drive system, you may copy the files from the distribution diskettes to the hard drive using the copy command in the operating system. First, setup the name of the directory in which you want to store the files. Then, copy them to the hard disk. If your system has no hard drive, copy the files to other diskettes. Most operating systems have a copy command that allows you to copy all files on a diskette with a single command. This is called a wild card copy. The copies will become your working copies. Prepare external labels for the working copies. Store the distribution diskettes in a safe place away from the microcomputer in case you need them in the future.

SET UP/INSTALL THE SOFTWARE.— Place the user manual with installation instructions next to the microcomputer and follow the step-by-step procedures.

Make sure you complete each task successfully before going onto the next.

The first step will probably be to execute the program from a setup disk or in a setup mode. You will probably execute a command that will lead you through a series of prompts and menus on the display screen. This will allow you to tell the program about your system and make initial settings. These settings will define your system and set the defaults. This means that everytime you execute the program, the settings will be what you specified. You will not have to reset them each time. For example, you might be asked whether you want the software to automatically backup your data. If you enter yes(y), it will ask you how often, every so many minutes. You enter the number. It may give you a choice of whether you want a beeper set to alert you to a given condition. For example, the system can be told to beep when certain error conditions occur. If the software is a wordprocessing program, you will want to specify the margin settings you normally want; for example, left margin at position 10 and right margin at position 75. You might want to tell it to automatically right justify print and to format date as mm/dd/yy. You can tell it whether the default setting for paper type should be continuous-form or single sheet; and so on. Once you have established the defaults, you will not have to change them unless you want something different.

You may also need to tell the software what type of printer you will be using. This will enable the program to send the proper signals to your particular printer. You may be able to define several printers and select the appropriate one when you use the software. Some software packages come with definitions for many printers, and it is a simple matter to tell it which you have by selecting the make and model number from a menu.

Occasionally, you will need to upgrade the software that you have loaded onto the computer. To do this, you will follow the same procedures that you did when the software was originally loaded. That is, read and follow the instructions included with the upgrade. Virus software is upgraded most frequently, with the discovery of new viruses that are out there.

WORKING WITH USERS

End users, especially first time users and noncomputer users, will need your help to operate their systems and their programs. They also need to know how to care for and handle diskettes, manage disks and

files, take care of the system, and perform user/operator maintenance. Don't be surprised when you get your first call for help. As you have learned, computers seem to have minds of their own and can do strange things. Help users by troubleshooting and identifying problems. Teach them what you know.

Using Software

Once you have the software installed and set up so it works on your system, the system is ready for use. Simple enough, you say—so what should I do first? You should boot either from the hard drive or by inserting the diskette that contains the operating system. You can set up the system so it will automatically boot when power is turned onto the system. Next, tell the operating system which program to use. Do this by entering the file name of the program following a prompt given by the operating system. For example, if the program is named WPP (for wordprocessing program), enter WPP and press the ENTER (RETURN) key. If you are using a hard disk, be sure to specify the directory used when you installed and set up the program. The operating system will then load the program into memory and the system is ready to do the work. From this point on, follow the instructions of the software package; in this example, a wordprocessing program. Refer to the user manual and any in-house user manuals that apply.

When you have finished your processing, return to the operating system before turning off the power. Do this by saving your work and exiting the program properly. Each program will have a procedure or command to end execution of the program and return to the operating system. If using diskettes, remove them from the drives, put them in protective jackets, and file them in an appropriate place. If using a hard disk drive, it is considered good practice to enter the operating system command to park the read/write heads. This will move the heads away from data storage areas so data will not be destroyed if the system is moved or accidentally bumped. Then turn the power OFF.

WORKING WITH SOFTWARE PACKAGES

When you work with packaged software, you will be concerned with what it does, how it does it, and how you are to interact with it. For each different type of application package, you will be confronted with anew vocabulary. For example, the terms used with word processing come primarily from the office/clerkal

environment (margins, tab sets, indenting, paragraphs, and so on). The terms used with desktop publishing come from the printing industry (fonts, type styles, points, and soon). Spreadsheets bring us the vocabulary of an accountant or bookkeeper (worksheets, rows, columns, data cells). Database terminology may look the most familiar to you, because many of the terms come from data processing (files, records, fields, keys, and indexes). First, we will look at the commonalities, then at the specifics of several different types of software packages—word processing, spreadsheet, database, desktop publishing, and utilities.

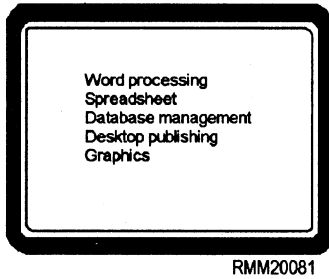

USING SOFTWARE PACKAGES

Regardless of the type of software package you are using on your computer, at a minimum, you will need to know how to conduct the following seven general operations:

- **Access** and **execute** the packaged software from the operating system.
- **Create** a new file or **retrieve** a previously created file on disk/diskette or tape.
- **Save** a file onto disk/diskette or tape.
- **Delete** a file stored on disk/diskette or tape.
- **Print** a file.
- Indicate to the packaged software that you want to **stop** working on what you are currently doing to do something on another file.
- **Terminate** your work via the packaged software and return to the operating system.

NOTE: Each software package will have specific ways you are to perform these functions.

A major consideration for a person working with packaged software is **file management**. You will need to know how files are setup, coded, named, backed up, and accessed. You will need to know who can access the

files, whether you can control access by others, whether you can protect the data, and whether the data is encrypted.

Learning About Software

The first thing you will learn is there is a lot to learn. You will need to know what functions you can perform, what keys activate what functions, and how to save the work/files you create. If a tutorial or learning section comes with the software, start with it. It will give you an overview. Then begin by experimenting and practicing on something you cannot hurt or destroy. Don't start with the master copy of a large database file. Instead, create a few records in a test file and practice on it. Try out each function, then try the functions in combination with other functions. Even make mistakes on purpose to see what happens. Did the software give you an error message? Can you recover? Does the software provide an undelete feature that lets you cancel what you just did? How much protection from error is built into the software? Does it give you a message such as: Do you really want to delete this file? Or, does it just assume when you hit the delete key you mean to? Most of the better software packages have built-in safeguards to protect us from ourselves. Recovery from operator/user error is a very important feature of many software packages.

Interacting with Software Packages

Basically there are only a few ways to tell software what to do. They are as follows:

- **Direct commands**— You enter words/characters via the keyboard to tell the software what to do. These words and/or characters are predefined by the software to perform specific tasks.
- **Menus**— You select the function or command you want performed from a list presented on the display screen by the software.
- **Function keys**— You select the function key (F1, F2, and so on) that is predefined to tell the software what you want it to do. This enables you to perform some of the more common commands without going through menus and with fewer keystrokes than required for direct commands.

- **Programs/macros**— You execute routines (a series of instructions/keystrokes) that have been developed and stored previously.

Which of these methods you will use depends on the design of the software; not all software includes all methods. Some software gives you a choice, and you can select the method you prefer. When learning, it is usually easier to use a menu because all the choices are presented. Once you have learned the software, you may prefer direct commands because you do not have to work your way through a series of menus to find the function or command you want. Programs/macros are most useful for repetitive tasks. They enable you to enter the sequence of keystrokes (steps) or characters you want to repeat. Once entered and stored, you can execute the entire sequence with one or two keystrokes—a real time saver.

Becoming a Proficient User

You will also learn that software does not do everything you want in the way you would like. The more you work with a package, the more you will be able to find ways around what you consider deficiencies. You will also learn you can compensate for these problems by writing and saving your own routines, programs, or macros to perform some of the more complex or awkward functions. Some packages enable you to define your own function keys, change the function of a key, or store routines as macro instructions. These are all desirable features for the more sophisticated users. This also means routines can be developed by experienced, proficient users for use by other users.

Do not hesitate to learn from others and do not limit your study. Ask others how they are using a package. What tricks have they learned and found useful? What routines/macros have they designed to perform recurring functions? Build on their knowledge and share yours. You might even institute a users group. It need not be formally organized—maybe during the noon time meal once a month.

Let's take a more in-depth look at some of the more commonly used software packages—word processing, spreadsheet, database management, and desktop publishing software.

WORD PROCESSING PACKAGES

Word processing packages are readily available for use in office environments on microcomputers. They

enable you to create, modify (insert, delete, rearrange), save, copy, and print documents (see figure 3-1). The usual method of entering a document is to type it on a keyboard. Another method is to use a scanner to read a printed document and encode it into a digital file for computer processing. You might also receive a document that has been transmitted over a network or phone system.

Creating and Modifying Documents

To create a new document, you will start by telling the system you want to create a document. In some packages this is the default option—the option you get if you do not specify something else. When you load and execute the program, you are in the create mode and simply start typing. The software will probably have a number of defaults that can be set up for your installation. For example, you can probably have defaults set to 8 1/2-inch by 11-inch paper, with a 1 1/2-inch margin at the top, a 1-inch margin at the bottom, and 1/2-inch margins left and right. You may be able to have tabs set as a default option for indenting paragraphs.

Regardless of how the original document is entered, eventually, it ends up as a data file on some type of secondary storage media that you can later access and modify (add, change, or delete). To make changes, you

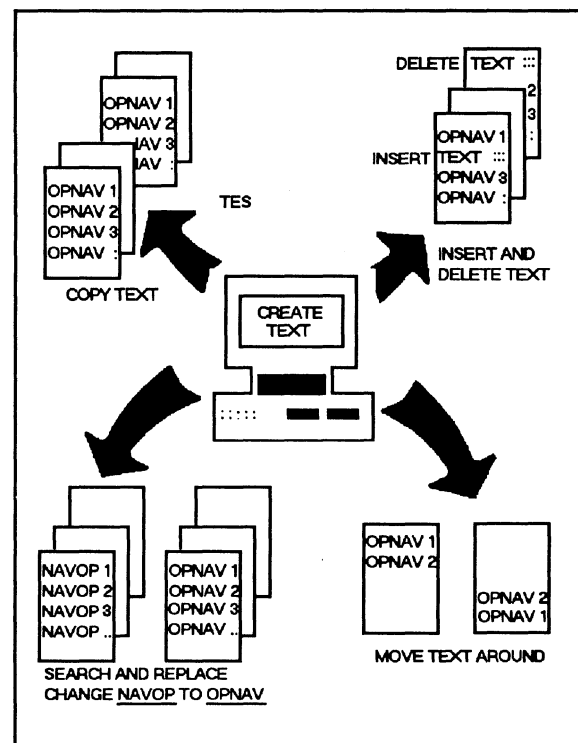

RMM20082

Figure 3-1.—Examples of word processing program features.

must retrieve the file into the computer's memory. The software displays the document on the screen. You then make entries by moving the cursor to the places in the document where you want to make changes. Two modes of operation are used—typeover and insert. As the words imply, if you are in typeover mode, you will replace what is presently there. If you are in insert mode, the material to the right of the cursor will move to the right as you enter new material. These, along with other features, are shown in figure 3-2. Take a few minutes to study the figure.

The basic features you will use are as follows:

- **Cursor movement keys**— Move the cursor up, down, right, left, to top/bottom of document, to next/previous page/screen; search to find a character string or function code in the document.
- **Insert mode**— To add letters/characters, words, sentences, and so on.

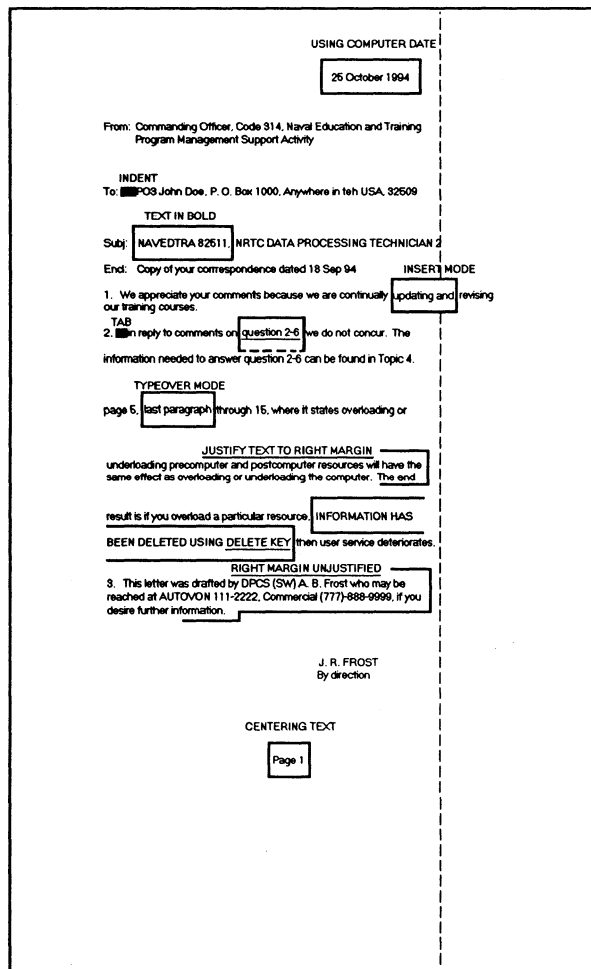

RMM20083

Figure 3-2.—Examples of basic features found in word processing packages.

- **Delete key**— To take out unwanted characters, words, sentences, and so on.
- **Backspace key**— To erase words to the left of the cursor one character at a time. (NOTE: In some packages this key may be defined differently. For example, it may backspace without deleting.)
- **Typeover mode**— To replace text by typing over it.
- **Wordwrap**— As you enter text, words automatically move to the next line when the right margin is reached. You do not have to press the return key at the end of each line as you do on a typewriter.
- **Cut and paste function**— Allows you to move material from one place in a document to another.
- **Function keys**— To underline, center, tab, indent; put text in bold; use subscripts/superscripts. You can put text in columns; add headers, footers, footnotes, page numbers, date, and so on.

Special Features

Many word processing programs include **dictionaries** and a **thesaurus**. These enable you to check for correct spelling and to look for synonyms. Some of the dictionary routines even provide a list of correctly spelled words you might have meant. In this case, you can correct a misspelled (or is it misspelled) word by selecting the correctly spelled word from the list on the display screen. The same is true of the thesaurus, the software lists synonyms on the screen. You select the one you want, and it replaces the original word with the selected synonym.

Some word processing programs have automatic **paragraph numbering** and **outlining** features. Once you have created the outline or document, you can delete or add entries, and the software will automatically renumber/reletter the outline or paragraphs in the document.

Some word processing programs have **indexing** capabilities. You can tell the software which words/terms are to be included in an index. The software will then automatically create the index in alphabetical order, with the appropriate page numbers.

Some enable you to create a **table of contents** or **other types of lists**.

Some word processing programs even include some of the features of a **spreadsheet package**. While they may not be as easy to use or as sophisticated, you can define **columns** and **rows** and perform some **arithmetic functions**. For example, you could total a column or calculate total cost of an order by having the software multiply the number of items by unit cost, and put the result in another column.

Some word processing programs enable you to set up **records** with defined **fields**. For example, you could set up a file of records with names and addresses. Let's say your organization sends a memo each month to the same list of organizations. Using a feature of the word processing program, you could create one letter and have the names and addresses inserted in (merged with) the letter automatically in the proper places. This is the same feature the sweepstakes companies use to insert your name throughout their letters to you to personalize them. This is sometimes called the mail merge function. It is unlike the merge function we think of in data processing in which the records in two or more like files are sorted in the same sequence by keys and then merged together into a single file. In mail merge, the variable information (name, address, and so on) is inserted in predefined places in a document and the document is printed.

Some word processing programs include many of the features of **desktop publishing**. You can view a finished document on the screen as it will appear on paper—WYSIWYG (what you see is what you get). You can scan art and insert it in the document. You can use a variety of type styles and sizes (fonts) if your printer can handle them.

Capabilities are continually being added and combined. You might have several electronic office tools all rolled up into one package—word processing with mail merge, database with report capability, spreadsheet with charting capability, and a communications package. How is that for an integrated software package! You will be able to use each tool as a separate entity, or you can integrate them together to produce sophisticated reports by combining text, graphics, and images in relatively complex multicolumn layouts. These packages will also include a graphical user interface (GUI) or lists of options (menus) presented on the screen, rather than having you memorize numerous computer commands to get the personal computer (PC) to do what you want.

SPREADSHEET PACKAGES

Simply defined, a spreadsheet electronically duplicates an accountant's or bookkeeper's tools, which normally consist of a ledger pad, a pencil (with an eraser), and a calculator. When using spreadsheet software, you enter and change data (figures of various types) by typing on a keyboard rather than writing with a pencil. You are able to view your figures on the computer's monitor rather than having to read a ledger pad. The data is presented as it would appear on paper, in rows and columns. Figure 3-3 is an example. Many everyday tasks can be managed with spreadsheet software. The computer can perform a variety of mathematical calculations—from simple addition, subtraction, multiplication, and division to trigonometry, and statistical and business calculations.

Understanding Spreadsheets

Before you can understand how a spreadsheet program works, you must first have an understanding of what the terms **record**, **column**, and **data cell** mean.

- **Record**— A record is represented by a line (row) of data items of information on a spreadsheet. This is the horizontal component of a spreadsheet. Normally, a record contains information about one particular item or topic, for example, a person or a piece of equipment. Spreadsheet rows are usually identified by numbers (1, 2, 3, and so on).

	NAME	SSN	RATE	BASE PAY	FICA	ST. TAX	FED. TAX
2	ABLE A.	111111111	DK3	1122.00	74.36	.00	168.44
3	ABLE B.	222222222	ETCS	2620.30	136.16	67.87	378.04
4	JANE J.	333333333	HM1	1707.30	102.86	.00	268.10
5	MARY S.	444444444	DP2		82.50	49.75	190.26
6	PAUL T.	555555555	RMCS	2150.10	124.90	119.56	323.42
7
8
9
10
11
12
13
14
15
16
17
18
19
20	WALTER T.	999999999	DPCM	2910.60	163.20	142.17	436.60

Figure 3-3.—Example of a spreadsheet/worksheet.

- **Column**— A column is the vertical component of a spreadsheet. A record (or row) can have many associated columns, such as base pay, FICA, state tax, federal tax, and so on. Each column contains one type of information and is normally labeled to identify the type it contains, such as base pay. The columns are usually identified by letters (A, B, C, D, and so on).
- **Data cell**— A data cell contains one piece of information associated with a particular record. Thus, a record/row that contains seven pieces of information will have—you guessed it—seven data cells. A data cell is symbolically identified by using some type of common notation—usually column, row. Therefore, if you have a spreadsheet with 20 records, each with 7 columns of information, the rows will be numbered from 1 through 20, and the 7 columns will be identified by the letters A through G. In this way, the fourth column, sixth row of the spreadsheet will be data cell D6, which, in figure 3-3, contains the value 2156.10.

The entire collection of data cells is often referred to as a **matrix** or an **array**. When entering data, it is not necessary to enter it in alphabetical or numerical order; the software package will normally arrange the data in whatever sequence you desire.

In looking at figure 3-3, you will notice each individual has only one record, and each record/row contains seven columns (or data cells) of information. There could have just as easily been 20, 50, or 75 columns of information per record. The number of data cells is limited only by the parameters of the spreadsheet software and by the amount of available RAM. To give you some idea of a spreadsheet's size, the worksheet you see in figure 3-3 might be only a small portion of the entire worksheet—the amount that can be displayed at one time. Although there appear to be only 20 rows and 7 columns of information, depending upon the software package you are using, it could conceivably contain up to as many as 8,192 rows and 256 columns of information totaling more than 2 million data cells. A spreadsheet of this size would be equivalent to a piece of paper approximately 21 feet wide by 130 feet long. Try spreading that out on a table!

Interacting with Spreadsheet Software

Like other software packages, you have cursor movement keys, function keys, and commands to tell the software what to do. The following list contains

some of the more common ways you can expect to interact with a spreadsheet software package:

- **Cursor movement** (or arrow) keys— You can move the cursor one cell at a time in one of four directions—up, down, left, or right. Other keys such as PgUp and PgDn move the cursor up or down one full page; still others, when used in conjunction with other keys, move the entire worksheet in a specific direction.
- **Function keys**— You can use F1, F2, F3, and so on, to display HELP screens, edit entries, display range names, enter absolute formulas, move back and forth between screens or windows, perform range and global recalculations, and so on.
- **Spreadsheet commands**— You can use commands to tell the software what to do.

Features of Spreadsheet Software

Spreadsheet software packages normally include ways to do the following things:

- **Enter** labels (non-numeric data).
- **Enter** values (numeric data).
- **Enter** formulas (to perform calculations, analyses, comparisons, and projections).
- **Insert** and **delete** columns and rows.
- **Copy** and **move** ranges of data cells/records from one area of a worksheet to another.
- **Erase** part or all of a worksheet.
- **Change** the way values are represented on part or all of a worksheet.
- **Split** the viewing screen to allow you to view two parts of a worksheet simultaneously.
- **Save, retrieve, rename, erase, and copy** files.
- **Print** a worksheet.

Figure 3-4 is an example of a printed spreadsheet showing the labels and titles, along with the values you entered (shown in italics), and the values calculated by the computer (shown in bold). Notice all the totals and subtotals were calculated by the computer. By using spreadsheet software, you need only enter a new price

MAGNETIC MEDIA REQUIREMENTS SPREADSHEET					
Item	Number to Be Replaced	Number for Expansion	Total Needed	Cost per Item	Total Cost
Tapes	15	30	45	27.50	1237.50
Disks	4	5	9	350.00	3150.00
Diskettes					
3 1/2-	10	30	40	1.75	70.00
5 1/4-	10	50	60	1.30	78.00
Subtotal	20	80	100		148.00
Total	39	115	154		4635.50

RMM20085

Figure 3-4.—Example of a printed spreadsheet.

when the price changes and direct the computer to recalculate the totals/subtotals.

Many of the available spreadsheet software packages will interact directly with other programs such as database and word processing applications. Some spreadsheet packages integrate (or combine) several programs into one, such as a spreadsheet program, a graphics program, and a database management program.

DATABASE PACKAGES

Before we get too involved in database packages, let us first define what a database is. The term *database* conjures up different images for different people. However, the concept is about as nontechnical and easy to envision as a filing cabinet full of file folders. The filing cabinet and its contents are the database. The ability to retrieve the data and calculate statistics quickly and easily without regard to which folder or drawer contains the information makes the database system much more powerful than a comparable filing cabinet system.

Let's consider a simple database, one which contains information about all enlisted personnel at your command in paygrades E1 through E6, including their NECs. First, you must establish a record in the database for each individual. Conceptually, you can think of it as a file folder containing information on one particular individual. You have one file folder, or record, for each individual in your database. In this case, we want to know the individual's name, rate, social

security number (SSN), division, and any NECs the individual currently holds.

Once you have defined the record, you then proceed to establish fields for each of the data elements. In this example the fields are name, rate, SSN, division, and NECs. If you assume each individual can have a maximum of four NECs, you would have a database containing eight fields, as shown in figure 3-5. You now proceed to create the database by establishing the fields, specifying their size and the type of information (numeric, alphanumeric, or logical) they can contain. Then, you enter the information for each individual into the appropriate fields. Once it is created, you can arrange the database in some logical order (by NAME, SSN, and so on). The database is normally stored on some type of secondary storage medium (usually disk), where the information is simply held until you need it.

Now, suppose you wanted a list of the E-5 and E-6 Storekeepers in the supply department with an NEC of 1234. Under a manual system, you would have to open and search through each individual's file folder—there could be hundreds! You would look at various entries; first, for rate (or the rate field in your database file); then, in order to see if this person is assigned to the supply department (the division field). You would then check to see if this person has an NEC of 1234 (the four NEC fields). Finally, you would have a stack of folders for all E-5 and E-6 Storekeepers who are assigned to the supply department and who have an NEC of 1234. You could then list the names from the file folders (the records) selected.

Depending upon the number of folders you have to look through, the entire evolution could take hours to complete. On the other hand, you could use one of the many database packages available to obtain the same answer. The database application program, by knowing the fields in each record and the content of each field, can easily search for this information in a matter of seconds. You simply specify the selection criteria and the report format; the software does the rest—searches

FLD 1	FLD 2	FLD 3	FLD 4	FLD 5	FLD 6	FLD 7	FLD 8
NAME	RATE	SSN	DIVISION	NEC 1	NEC 2	NEC 3	NEC 4

RMM20086

Figure 3-5.—Example of a database record.

the database for the records that meet the criteria (SKI or SK2, Supply Department, and NEC 1234). The computer then displays or prints the requested information in the format specified. See figure 3-6. You do this through the **query** and **report features** of the database package. Doesn't that beat manually searching through a drawer full of folders, which could take hours?

A database is nothing more than a collection of data—many file folders or individual records containing several fields or data elements. The database is organized to allow you to retrieve, update, and have ready access to various information that can be formatted and printed as you desire. The database itself doesn't do anything; it just holds information.

Understanding Database Software

To understand how a database program works, you first need to have an understanding of certain terms. Some of the terms you are already familiar with, whereas others you may not be. These include **database, record, field, pointer, index, primary key, and secondary key**. They are defined as follows:

- **Database**— A database holds information that is related to a specific type of application—payroll, personnel, supply inventory, and so on. In this context, the term *database* is often considered synonymous with file. This is especially true when dealing with database files.
- **Record**— A record consists of a group of related fields, all pertaining to the same subject: a person, a thing, or an event.

SUPPLY DEPARTMENT E-5 AND E6 PERSONNEL WITH NEC 1234			
<u>Rate</u>	<u>Name</u>	<u>SSN</u>	
SK2	Boat, P. T.	55555555	
SK2	Seaman, A. B.	88888888	
SK1	Doe, J. A.	11111111	
SK1	Doe, J. B.	33333333	
SK1	Frost, J.R.	123456789	

RMM20087

Figure 3-6.—Example of a database report.

- **Field**— A field consists of one unit of information. A field is also referred to as a data item or a data element. It may be alphabetic, like your name (John or Jane Doe); numeric, like your ZIP Code (01234); alphanumeric, like your post office box or street address (P. O. Box 669 or 1234 Main St.); or logical (true/false), like on leave (true-on leave, false-not on leave).
- **Pointer**— A pointer is a data item in one record that identifies the storage location of another logically related record.
- **Index**— An index enables you to access records in a database (also referred to as database file or file) in the order of the index regardless of the physical sequence of the records in the database. You can think of indexing as sorting without having to sort. The index itself is a file. It contains a duplicate of the key field (or fields) such as account number, or name and security number, and a pointer to the actual disk record identified with this key in another permanent disk file. For example, if there are 5,000 records in your database, and the key field happens to be SSN, then the index would also contain 5,000 entries with each entry having an SSN. It is also possible for you to have one or more secondary indexes that contain other various secondary key fields.
- **Primary key**— The primary key in a database consists of a unique identifier for a particular record and should only point to a single record in the database being indexed.
- **Secondary key**— Data are normally arranged within a database in some type of order, depending upon the contents of one or more fields. Secondary keys allow you to access the database in different ways. For example, your database might be arranged in the order the records were entered. You can then set up a secondary index (or key) by the name field, or by the social security number field. You may specify any number of secondary keys. You might index by more than one field. For example, you could index by last name within rate, as shown in figure 3-6.

Database Organization Methods/Structures

Databases can be **list, hierarchical, network, or relational** in structure. The major advantage of a

database is it permits the maintenance of a related set of files or tables that can provide information to several different users. So how do these database structures differ? you might ask. That's a good question. Read on and find out.

LIST DATABASES.— List databases link records together through the use of pointers. The pointer is a data element in one record (normally the master record) that points to the actual disk location of another logically related record, as illustrated in figure 3-7.

HIERARCHICAL DATABASES.— Hierarchical databases consist of elements that act in a superior-subordinate or parent-child relationship. What this means is that one element is linked to another element in the database. The **superior** element points to one or more **subordinate** elements. There can also be a subordinate of a subordinate, which will enable many hundreds of elements to be connected. See figure 3-8.

NETWORK DATABASES.— Network databases are very similar to hierarchical databases except that an element can have **one or more superiors**. Network structure permits the connection of the nodes multidirectionally. Each node may have several owners (or elements) and may own any number of other data elements on the network (see figure 3-9). The database management software permits the extraction of needed information from such a structure to begin with any record in the file. Although network databases are more

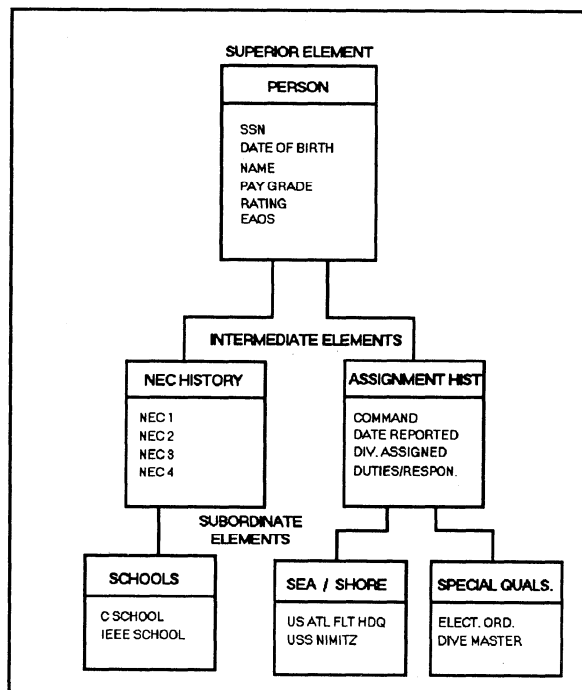

RMM20089

Figure 3-8.—Example of a hierarchical database structure.

flexible than hierarchical databases, they still have limitations. The networking scheme must be defined when the database is initially created, and information retrieval is based solely on the predefined scheme.

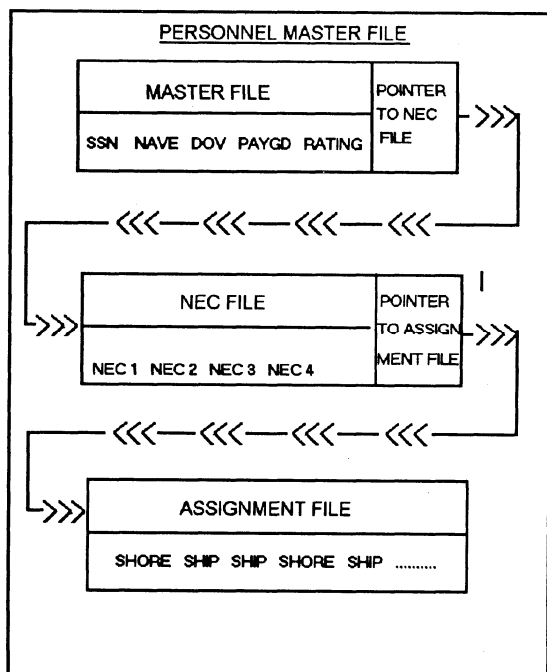

RMM20088

Figure 3-7.—Example of a list database structure.

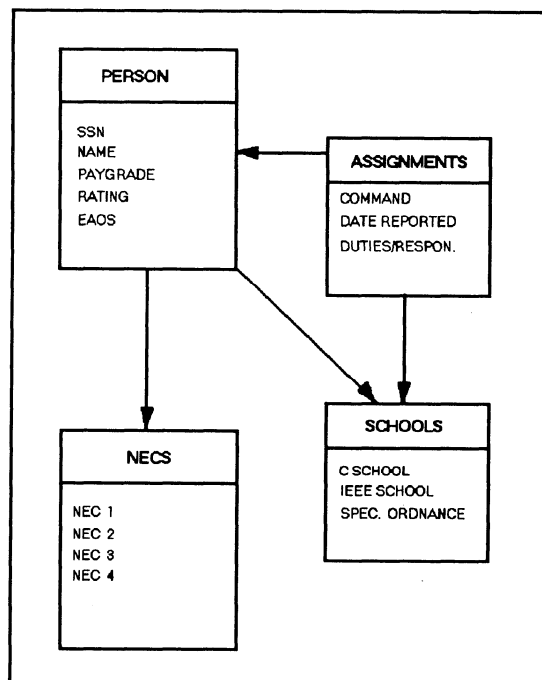

RMM20090

Figure 3-9.—Example of a network database structure.

RELATIONAL DATABASES.— Relational databases have many advantages over network and hierarchical databases. They consist of **one or more tables** in which data are stored in the form of **rows and columns**. The main advantage is that relationships between the data can be established whenever you (the user) request information. For example, relation tables could be used to link a person with his/her NECs, duty assignments, and any special qualifications, as shown in figure 3-10. Many other relations are, of course, possible. Any relational database package **normally uses an index** of some sort for faster access to the data. Relational structures are a very popular database structuring approach for both mainframe and microcomputer database packages.

Using Database Software

Some of the more common operations you can expect to perform when using a database software package are as follows:

- **Create** databases.
- **Insert, update, and delete** data in a database.

PERSON			
SSN	DOB	NAME	EAOS
111111111	110245	DOE J. A.	1296
123456789	081654	FROST J. R.	0694
333333333	022637	DOE J. B.	0895
555555555	041268	BOAT P. T.	1093

NECS			ASSIGNMENTS		
SSN	RATE	NEC	SSN	CMD	DIV
111111111	SK1	1234	111111111	NSC.....	SUP
123456789	SK1	4567	123456789	USS.....	OPS
333333333	SK1	3333	333333333	NATO.....	ADM
555555555	SK2	1234	555555555	USS.....	SUP

SCHOOLS			
SSN	SCHOOL	SPECIAL QUALS	
123456789	A SCH		
333333333	C SCH	ADV. STRKPR TR	
555555555	SNAP C	ADV OPER TRANG	

OTHER RELATIONS — DATE REPORTED, DUTY SECTION

RMM20091

Figure 3-10.—Example of a relational database structure.

- **Create and run** forms and reports, **design** and print labels.
- **Query** the database for information.
- **Create and run/execute** applications programs.
- **Import and export** files.

You can use function keys F1, F2, and so on, to provide help screens, to display lists of items, to design database files, queries, reports, forms, and labels; to add fields to a layout, to move or copy selected data, to enlarge/shrink fields or condition boxes, to print a quick report, to access menus for the current screen, to access macros, and so on.

Some database packages provide you with some type of control screen like the one shown in figure 3-11. Using a control screen allows you to access a number of features. This particular control screen has six panels, each corresponding to a different type of operation on your database. Displayed across the top left-hand corner of the control screen you see three main menus— **Catalog, Tools, and Exit**. **Catalog** provides you with options for managing catalogs and the files contained in them. A catalog is a file in itself that contains the names of related files. **Tools** provide you with a variety of utilities for accessing the disk operating system (DOS), for importing and exporting files, and for setting program parameters. **Exit** enables you to leave the control screen and go back to the disk operating system.

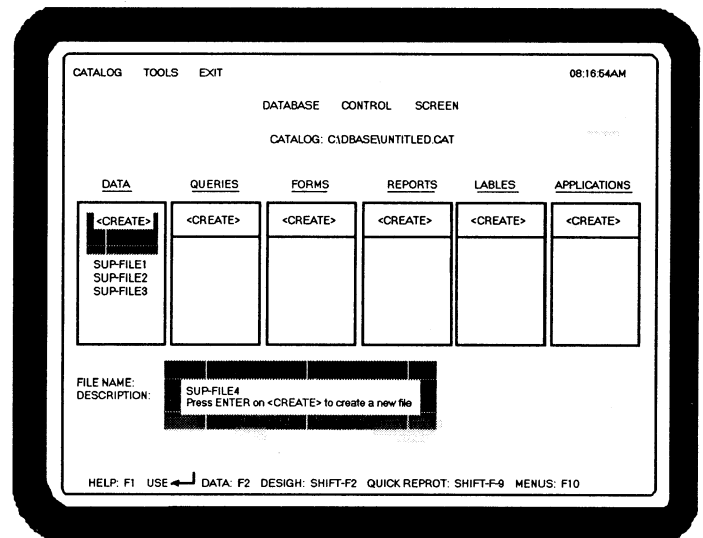

RMM20092

Figure 3-11.—Typical control screen used with database applications.

Most database packages provide you with some type of **query language** that allows you to query a database to obtain answers about the contents of the database, insert new data, update information in various tables, and create views. By using various commands and control statements, you can perform arithmetic, logical, and comparison operations on the data you have selected.

DESKTOP PUBLISHING PACKAGES

Desktop publishing (DTP) packages are used primarily for designing and publishing professional looking documents. They offer you a wide variety of publishing applications. Typical applications include newsletters, advertisements, letterheads, reports, presentations, catalogs, books (such as this TRAMAN), brochures, or flyers, forms, business cards, contracts, magazines, and overhead displays. Again, you will see and hear new terms when you begin working with desktop publishing software. These terms come primarily from the printing/publishing industry.

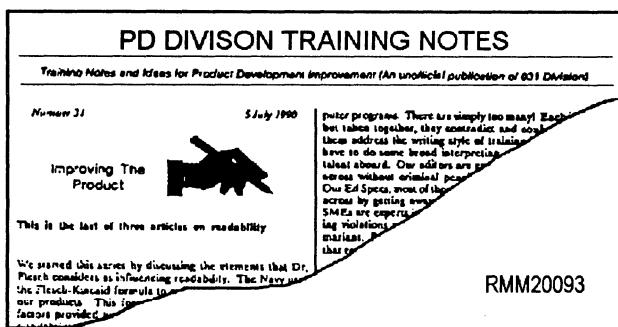

The features of desktop publishing can be categorized as **composition**, **layout**, and **graphics**. Let's take a look at each area.

Table 3-1.—Table of Type Styles in Several Fonts

Courier, 8 point
Courier 10 Roman, 10 point
<i>Courier Italic, 12 point</i>
Roman-WP, 18 point
<i>Roman-WP Bold Italic, 24 point</i>
Roman-WP Bold, 36 point

Desktop Publishing Composition

Composition includes defining the sizes and styles of type to be used, the amount of space to allow between horizontal letters and vertical lines, and coding the text (copy) to meet these standards and definitions.

You can enter and edit text directly or you can input text created using a word processing program. Documents created in word processing programs can be **imported** into the DTP software. Once they are imported, you can manipulate the text (copy) any way you want to satisfy your particular publication needs. The following are features and terms you need to become familiar with:

- **Type styles and sizes**— Type is classified according to its style of letter and size. You can choose a variety of type styles (typefaces) and sizes to create impressive forms, letterheads, brochures, flyers, and so on. Examples of Courier and Roman-WP are shown in Table 3-1. Notice each is in a different size. Printers' measurements are based on the point system. The point is approximately 1/72 of an inch. When you hear someone say 8-point type, that simply means that the body of the type measures 1/9 of an inch from top to bottom; 12-point type measures 1/16 of an inch, and so on. The typeface itself is seldom as large as the body, because a small shoulder or ledge is left below the letter on most type. Type sizes range from 3- to 120-point. You will also see the term *font* used in connection with desktop publishing and word processing. A font is a collection of characters of unified design—the typeface and point size are needed to specify a font. However, the term *font* is often used interchangeably with typeface.

- **Letterspacing and leading**— You can adjust space both horizontally and vertically. Letterspacing refers to the addition of small spaces between l|e|t|t|e|r|s within a word. Leading refers to the space added between lines of material.

You can create an index or table of contents by marking special words for an index or use headings and sideheadings to make a table of contents.

Desktop Publishing Layout

Layout involves arranging the text and graphics on the page. The text may flow from column to column on multicolumn documents like the newspaper. You may have to move text from one part of a document to another using the electronic pasting features. You can incorporate illustrations on a page with text. Borders may be drawn around text or illustrations. Illustrations may be sized (made smaller or larger), and additional letter spacing and leading may be added to create a full page. To lay out a pleasing document requires experience and practice as well as a good eye for balance. You will find the following features in most desktop publishing packages:

- **Lay out pages and edit page layouts**— You can lay out pages electronically, rather than having to cut and paste using scissors and glue.
- **Incorporate text and graphics**— Your text and graphics can be electronically merged together in the layout.
- **Multiple columns, column widths, and heights**— The software automatically formats multiple columns on continued pages. You specify how many columns are to be on a page and the amount of gutter space desired. Gutter space is the amount of space between columns.
- **Vertical/horizontal printing**— Material can be printed either vertically or horizontally on a sheet of paper.
- **Fit copy to page**— You can fit the copy to a page either by reducing the type size, increasing or decreasing borders or margins, and any other number of creative ways you can come up with—changing the size of an illustration, cutting off (cropping) an illustration, or even rewording some of the text.

- **Automatic page numbering**— You can have the software automatically number the pages.
- **Headers and footers**— You can also have appropriate headers (titles) at the top of every page and footers at the bottom of every page. Headers or footers can usually include page numbers.

Desktop Publishing Graphics

Desktop publishing packages have the capability to scan or import illustrations/graphics either from hardcopy or from digital data. The following are graphics features you can expect to find in DTP packages:

- **Graphic images**— You can add images, borders, lines, arrows, and so on, of various sizes to the text.
- **Shrink/expand and edit images**— You can reduce or enlarge images to fit in a desired space. If necessary, the images can be altered or edited.
- **Accept images from scanners or other draw programs**— You can import images from a scanner or digitizer. These images can be in either text or graphic form. Images can also be imported from either a paint or draw-type graphics package.
- **Layered output for color printing**— You can create camera-ready copy for color separation work when an outside printing process is required. Color work is done by creating up to as many as four film negatives (one for each of the primary colors—red, yellow, and blue) plus black. Each negative is used to create a separate printing plate for each color. Then, as the colors are overprinted, the color of the original photograph is reproduced.

Hardware Requirements

Unlike the software packages previously discussed, desktop publishing packages (and graphics software packages) require a considerable amount of resources. To give you a better idea of what we are talking about, the following are hardware requirements:

- **Microprocessor**—At a minimum, you will need a 486 sixteen-bit microprocessor or equivalent. A Pentium or 586 (or equivalent) is even better.

Do not plan on using PCs based on 286 and 386 microprocessors. These machines simply do not have enough computing power to handle DTP chores efficiently.

- **Monitor**— You will need a high-resolution 19-inch monitor. When doing desktop publishing and design work, laying out pages on most standard 12-inch and 13-inch screens can be tiring and difficult. The monitor and associated graphics card should be at the IBM-standard video-graphics array (VGA) level or better.
- **Secondary storage**— Large hard disks are essential for DTP work. Desktop publishing files tend to get very large, and you will soon accumulate many active files on the computer's hard disk. A minimum of 500 megabytes of hard disk capacity is recommended. Hard drives with 850 megabytes to 2 gigabytes are even better.
- **Mouse or trackball**— You will also need a mouse or trackball pointing device to move the cursor position on the monitor screen.
- **Printer**— Although the dot matrix printer is inexpensive and capable of printing graphics and letter quality text, it is insufficient for many DTP applications. A laser printer is the better choice when it comes to preparing quality text and graphics.
- **Scanner**— With desktop publishing systems, you will naturally want a desktop scanner to capture photographs, art work, clippings, and other forms of art work.

More and more DTP functions are being added to word processing packages. For some applications, this will eliminate the need for separate DTP packages. However, you will still need a scanner, a mouse, and a compatible laser printer.

UTILITIES

Software utilities further enhance your computer's capabilities and make it run more efficiently, whether it be a mainframe, mini, or micro. Once a computer user like yourself becomes familiar with the system and applications software you are working with, you want the system to do more and do it faster and more efficiently. Utilities can satisfy some of this need for more computer power, overall performance, internal security, file and data management, and backup capabilities. Utilities strive to fill some of the voids left

by applications or operating system software. For the most part, utilities are meant to work in conjunction with your existing software.

In the past, an individual had to be a technical expert when it came to setting up the necessary control parameters for a particular utility program (a sort, merge, selective print, and so on). Quite often, they were complicated to run. Some of these utilities were stand-alone programs occupying a niche not filled by applications programs. The traditional mainframe utility programs, such as sort, merge, and print, have given way to desktop organizers and file managers that are now geared for individual use on a personal computer. Today, most microcomputer users initiate a wide variety of software utilities and are not even aware they are doing so. Some of the more popular utilities have been incorporated into the disk operating system as well as applications programs as commands.

DOS includes such utilities as COPY, SORT, FORMAT, BACKUP, RESTORE, TYPE (to print files), DIR (to list files in directories), RENAME (to rename files), CLS (to clear your monitor's screen), and many, many more. Utilities such as spell checkers, dictionaries, thesauruses, and grammar checkers are often included in word processing packages. Many applications programs include keyboard enhancing programs that allow you to store frequently used words and sentences you can then access with either a single keystroke or combination of a few keystrokes (also known as hot keys). Then, there are mouse utilities that allow you to program the right and middle mouse buttons for particular tasks.

While utility programs are getting easier for us to use, selecting the best one to accomplish a particular task can be somewhat difficult. If you look around to see what utilities are available, you will find there are thousands of various types on the market to choose from. To introduce you to the types, we have organized the various utility software/programs into eight categories: keyboard enhancement, desktop organizer, backup, file management, file maintenance, DOS shell, printer, and virus utilities.

Keyboard Enhancement Utilities

Keyboard enhancers, as the name implies, enhance the function of the PC keyboard. These programs (which are usually RAM resident programs) translate a single keystroke into user-defined **macro** commands. A macro consists of one instruction that represents many instructions. For example, Ctrl-Alt-C keystrokes

could be simplified as the Esc key with a user-defined macro. Any string of keystrokes or characters can be stored as a macro. More importantly, once you have defined the macro, it can be stored as a file for use with different applications. In short, by shortening commands and character strings, keystroke repetition is greatly reduced.

Desktop Organizer Utilities

Desktop organizers consist of programs that emulate such things as calculators, notepads, phone directories, calendars, and appointment books. Most of these utilities are RAM resident. This means they can be accessed from within other applications programs. For example, you can call up the calculator utility while you are currently working in a word processing application. An image of a calculator will “pop-up” in a small window on your monitor’s screen. You then perform the necessary calculations, and return to the word processing application. Some desktop organizers allow you to take the resulting calculation and place it directly into the word processing document you are working on. This is referred to as “cut and paste.” Most programs included in desktop organizers also operate in this pop-up mode.

Backup Utilities

As computer specialists, we should all be familiar with backup utilities. Disk backup utilities provide us a cost effective way to backup a hard disk. Advanced features, such as automatic backup (backups taken at predescribed intervals), file compression (which allows more data to be placed on a diskette), and automatic disk formatting, make disk backup utilities a good alternative to the backup utilities supplied with most operating systems. Backup utilities also allow you to save your files to tape, or even to another hard disk.

File Management Utilities

As the capacities of hard disks increase, so does the need for file management utilities. Try keeping track of the files on a 2Gb hard disk without any type of file management utility. It is next to impossible. Adding to the problem can be a maze of subdirectories—originally set up to keep order—that can easily hide a file or two. File management utilities help you avoid these problems by manipulating files and directories. They perform tasks such as searching for files, deleting files, tagging files (to allow for file manipulation on groups of unrelated files), relocating files, and setting

file attributes. In short, file management utilities provide you with a convenient way to keep hard-disk directories, subdirectories, and the files themselves organized and under control.

File Maintenance Utilities

File maintenance utilities include file recovery utilities (including backup and restore) and programs that manipulate files, such as data compression and file security programs. File recovery utilities are designed to identify, diagnose, and repair every form of data and low-level format damage on standard DOS hard disks. One of the most critical areas of file maintenance is file recovery. If you should accidentally erase a file, it can easily be recovered (unerasd) by using a recovery utility.

Compression utilities save disk space by reducing file size by 40 to 60 percent. Encryption utilities are designed for file security. Using one of several encryption algorithms, these utilities will encode a file so that it is readable only by reversing the encryption process. Other utilities are designed to “hide” files from the operating system; that is, the file “disappears” from the operating system and is only accessible with a password. Still others are designed to control access to files, programs, and communications devices.

DOS Shells

These utilities, called DOS shells, help translate DOS codes into English words, phrases, and diagrams. They act as a liaison between you and the operating system. They display disk and file information, adding commands not available in DOS and tend to simplify the execution of standard file management commands, such as DELETE, COPY, and PRINT.

Printer Utilities

Printer utilities provide software support for the enhanced fonts and graphics found in many printers. They also provide such features as menu control for printer functions, print spooling, and printing horizontally. Printer utilities allow you to use a printer that your applications software may not support. They also allow you to make better use of your standard printer.

Virus Utilities

Virus utilities are designed to keep out the malicious logic (unfriendly viruses) that attack

computer system software. This type of software is designed to prevent both known and unknown viruses from invading a system, and to detect and remove those already present. Virus detection software (IBMAV) is available free to all DON activities from Naval Command, Control and Ocean Surveillance Center In-Service Engineering, East Coast Division (NISEEAST), in Charleston, South Carolina. For more information concerning virus software, refer to chapter 2 in this module.

Utilities of the Future

What can you expect to see in the future? More and more, you will see vendors combining several utilities into one package. These packages will be difficult to categorize because they will work with operating systems, application programs, and peripherals. For example, a file maintenance utility may combine several commonly used programs such as disk diagnostic and recovery utilities, a DOS shell, hard-disk backup, a desktop manager, and a disk optimizer (a compression utility).

So, how do you go about staying on top of the latest and greatest utility packages available? That's easy! You can learn about utility programs by reading trade magazines and software reviews. Let the experts do the leg-work of evaluation for you. There are so many utilities available on the market that it would be impossible for you to do a good job of evaluating them on your own. Vendors of application software and local computer clubs are other good sources of information.

USER REQUIREMENTS

To translate user requirements into technical terms, the first skill you will need is the ability to communicate with the users. Usually, the users know what they want and need, but they do not always know how to phrase it and put it into a logical process. That is where you, the computer specialist, come into play. As communications specialists, we have to be able to translate their ideas into a logical process. One effective method we can use is pseudocode because the code can be easily read and understood by both users and communications specialists (figure 3-12). After we determine the process and document it in pseudocode, we take the pseudocode to the users for their review to make sure we have covered all of their needs. After talking with the users, we make any necessary changes, then go back to the users again. As the programmer, it is your responsibility to determine the necessity and feasibility of the user's requirements to avoid unnecessary or even impossible programming. We continue this process until the users have no more changes and approve the pseudocode. The approval is required before moving on to the development of the program requirements.

Determine System Software Requirements

When we start to determine the system software requirements, we look at the pseudocode and the user's requested end product(s) to determine whether a commercial software package is available to accomplish the job or if we will need to develop an in-house program.

```
PAYROLL-PROCESS
  Perform initialization.
  Perform calculate-pay UNTIL employee name equals "END OF DATA".
  Perform termination.
  STOP.

INITIALIZATION
  Display report headings.
  Accept input record.

CALCULATE-PAY
  Move input field to print buffer.
  If hours worked greater than 40
    Compute gross pay include time and one half for over 40 hours.
  Else
    Compute gross pay equal to hours worked times hourly rate.
  Display employee record.

TERMINATION
  Display "End of Report" message.
```

RMM20094

Figure 3-12.—Pseudocode example.

To determine whether the job can be done with a commercial software package, you need to be aware of the different software packages available and their capabilities and features. If it appears you can use a commercial software package and your AIS facility does not have it, start looking at the different government contracts in effect to locate the particular software package you are interested in. If the software is not available on contract, you will have to look for outside sources. Once you locate the software package and obtain approval for purchase, you can start the process of filling out the paperwork to order the software.

If you determine no commercial software is available to accomplish the user's request, you need to look at the expertise available in your AIS facility and what programming software is available at your facility to accomplish the job. Powerful software is available to make the programmer's work easier. This software falls into one or more of the following categories:

- **Query languages.** Allow records to be printed or displayed in a specified format.
- **Database languages.** Allow records to be added or retrieved and manipulated following set formats.
- **Report generators.** Allow reports to be created from retrieved data records.
- **Application generators.** Allow the use of pre-written modules in creating a program.
- **High-level languages.** Allow the programmer to create a program from scratch.
- **Generalized software.** Directs certain internal computer functions.

Determine System Hardware Requirements

Once you determine the source of the program, whether a commercial or an in-house program, you need to look at what type of hardware will be required. Commercial software will have the hardware requirements stated in the paperwork. The users may have certain hardware requirements dictated to them that will have to be met. For example, a laser printer, a specific type of floppy drive, or a CD-ROM drive may be required. For in-house programs, it may be more difficult to determine the hardware needed until the program specifications are complete.

When additional hardware is required, you should first determine if it is available at the facility. You may

find the hardware needed is not being used where it is located and you can move it to meet the new requirements. If the hardware is not available at the facility, begin the acquisition process. This process is the same as for software, except, in most cases, the requirements will have to go out on bids to several companies. With this process, it may take a long time to receive the hardware. You should plan accordingly.

Calculate Memory Requirements

When translating user requirements into an application, there are several things to keep in mind. We have covered the system software and hardware requirements; now, we turn our attention to the memory requirements. Calculate the memory requirements carefully; it will do no one any good to create a program that can not be run due to memory constraints of the system. Factors to be combined when calculating memory requirements are:

- the operating system,
- the program, and
- the data to be input.

By taking into consideration the memory requirements of each of these factors, there should be no problems (as far as memory goes) with running the programs.

I/O AND PROGRAM SPECIFICATIONS DEVELOPMENT

Once you develop the pseudocode and identify the software and hardware requirements, you can begin developing the I/O and program specifications. This is also a good time to determine what type of file organization method will best suit the application. The I/O specifications will require the users interaction to further detail what they need as input data and output material. They are your primary source for this information. To prepare the program specifications, you will use the pseudocode and design the program to match. Also, look at the memory and storage requirements for the program. You may have to adjust the hardware requirements to match the program specifications. Be sure you are not going to overload the computer system.

File Organization

File organization is the technique of physically arranging the records of a file on a storage media. When the programmer creates a subschema, a determination must be made on how the file will be accessed by the program. The three file organizations methods used are: sequential, indexed sequential, and direct.

- **Sequential file organization.** In sequential file organization, the records are in the same order as they were written to the file.

- **Indexed sequential file organization.** In indexed sequential file organization, the records are stored in sequence according to a primary key and an index is created to allow random access of the file. This type of organization also allows the file to be accessed sequentially. Indexed sequential is the most commonly used type of file organization.

- **Direct file organization.** In direct file organization, the records are stored and retrieved using a relative record number, which gives the position of the record in the file. This type of organization also allows the file to be accessed sequentially.

DATABASE MANAGEMENT SYSTEMS (DBMS)

A database management system (DBMS) is a software package that provides an integrated source of data for multiple users, while presenting different views of that data to different users. It can be characterized as generalized software that provides a single flexible facility for accommodating different data files and operations, while demanding less programming effort than conventional programming languages. It features easy access to the data; it facilitates the storage and maintenance of large volumes of data; and, most importantly, it provides the capability for sharing the data resources among different types of users.

Database management systems range from elementary systems with single record structures, providing rudimentary report formatting facilities, to very elaborate systems. The very elaborate systems

handle several files with hierarchical or relational structures, perform functions in an online mode, and have sophisticated query and report writing capabilities.

DBMSs are being used on a wide variety of computers in the Navy. Because of this, no one DBMS by any single manufacturer is discussed in this chapter.

Most of the problems with DBMSs in Navy computer systems are the same as in the civilian workplace. A few of these problem areas are noted below:

- Users do not want to share their data with others in the database.
- Data representation is inadequate.
- Privacy and safeguarding of proprietary information are not sufficient.
- Different views of data are needed by technical and nontechnical DBMS users.
- Data structures are not tailored to individual user requirements.

The wide use of DBMSs in the Navy indicates that all or most future operating systems will be oriented primarily toward DBMS. Slowly, but surely, the DBMS problems in the preceding list are being eliminated through better and more sophisticated software, coupled with advanced training of users on such software usage.

Take a look at the changes that have been made from the conventional system file structure to the database management system structure. As shown in figure 3-13, a conventional system is many application

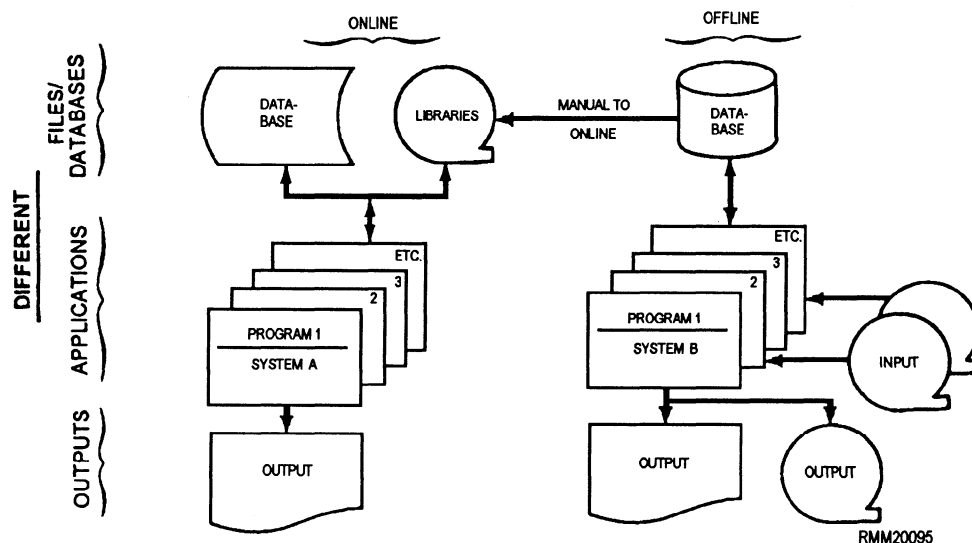

Figure 3-13.—A conventional system.

programs or systems using different databases and files. These databases and files are systems that are either online or offline; at any rate, they must be online at execution time. Under a conventional system, when the same data was needed in SYSTEM A and in SYSTEM B, it was usually duplicated. This redundancy of data is not acceptable to the AIS community. The following problems are just a few of those that exist when redundancy of data is required:

- Excess storage is required.
- An excessive number of personnel is required to handle and manipulate the data.
- A greater chance of error is possible when updating all the common data in different databases and files.
- Excessive funds are expended for report production for management.
- Excessive CPU time is expended when collecting data for reporting.
- Data integrity is harder to maintain because of the greater chance of error.

To overcome these problems, many Navy AIS facility are using a DBMS. This has produced a better record in operations and productivity than its

predecessor, the file management system. DBMS software evolved from many different software improvements, from many different manufacturers. None of the many DBMSs function exactly alike. Regardless of the manufacturer's software installed at a particular AIS facility, a basic DBMS can be conceptually depicted as shown in figure 3-14. Take a few minutes to study the figure and refer to it as you study this section. You need to understand the concepts before we pictorially depict a DBMS execution event. The concepts include schemas, subschemas, data definition language (DDL), and data manipulation language (DML).

Schema

A schema is a complete description of a database, and consists of data definition language (DDL) entries. It includes the names and descriptions of *all* of the areas, set types, record types, and associated data items and data aggregates as they exist in the database and are known to the DBMS. In other words, it is the overall logical database description or framework into which values of data items can be fitted. A schema can be viewed like the bins in a storage house holding supplies. The schema will not change, but the data values will.

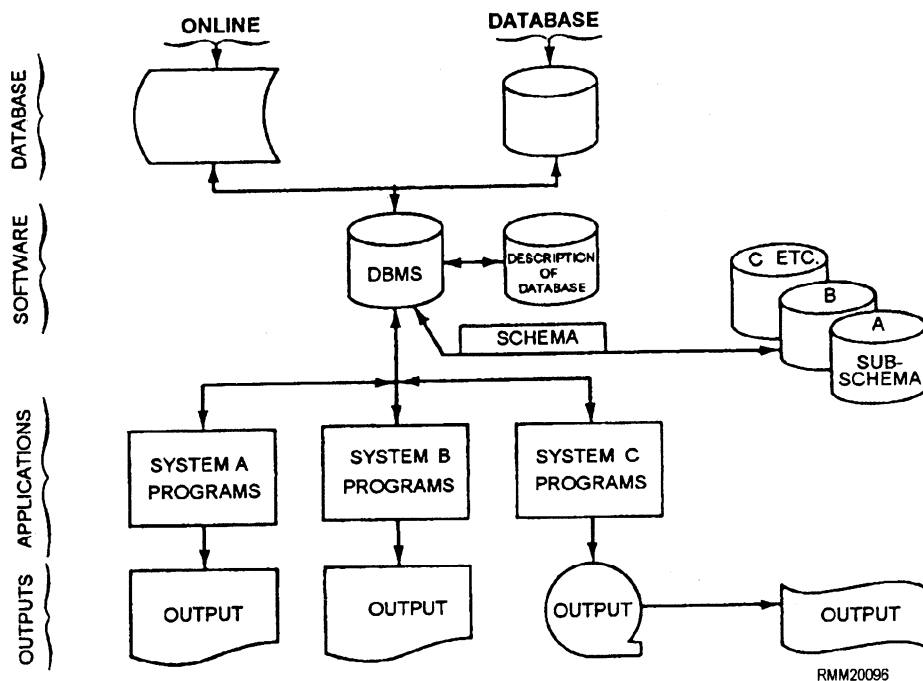

Figure 3-14.—A database management system (DBMS).

Subschemas

A subschema is the applications programmer's view of the data within the database pertinent to the specific application. A subschema has access to those areas, set types, record types, data items, and data aggregates of interest in the pertinent application to which it was designed. Naturally, a software system usually has more than one programmer assigned and includes more than one application. This means there are usually many different subschemas for each schema.

The following are a few of the many reasons subschemas are used:

- Subschemas provide different views of the data to the user and the programmer, who do not need to know all the data contained in the entire database.
- Subschemas enhance security factors and prohibit data compromise.
- Subschemas aid the DBA while assuring data integrity.

Each data item included in the subschema will be assigned a location in the **user working area (UWA)**. The UWA is conceptually a loading and unloading zone, where all data provided by the DBMS in response to a CALL for data is delivered. It is also where all data to be picked up by the DBMS must be placed.

Schema Data Definition Language (DDL)

The schema data definition language (DDL) is used for describing a database, which may be shared by many programs written in many languages. This description is in terms of the names and characteristics of the data items, data aggregates, records, areas, and sets included in the database, and the relationships that exist and must be maintained between occurrences of those elements in the database.

• **Data item.** A data item is an occurrence of the smallest unit of named data. It is represented in a database by a value.

• **Data aggregate.** A data aggregate is an occurrence of a named collection of data items within a record. There are two kinds—vectors and repeating groups. A vector is a one-dimensional sequence of data items, all of which have identical characteristics. A **repeating group** is a collection of data that occurs a number of times within a record occurrence. The

collection may consist of data items, vectors, and repeating groups.

• **Record.** A record is an occurrence of a named collection of zero, one, or more data items or data aggregates. This collection is specified in the schema DDL by means of a record entry. Each record entry in the schema for a database determines a type of record, of which there may be an arbitrary number of record occurrences (records) in the database. For example, there would be one occurrence of a PAYROLL-RECORD type of record for each employee. A **database key** is a unique value that identifies a record in the database to a run unit (program(s)). The value is made available to the run unit when a record is selected or stored and maybe used by the run unit to reselect the same record.

• **Set.** A set is an occurrence of a named collection of records. The collection is specified in the schema DDL by means of a set entry. Each set entry in the schema for a database determines a type of set, of which there may be an arbitrary number of set occurrences (sets) in the database. Each type of set specified in the schema may have one type of record declared as its owner type of record, and one or more types of records declared as its member type of record. Each set occurrence (set) must contain one occurrence of its defined **owner type of record** and may contain an arbitrary number of occurrences of each of its defined **member type of record** types. For example, if a set type QUALIFICATIONS was defined as having owner record type EMPLOYEE and member record types JOB and SKILL, each occurrence of set type QUALIFICATIONS must contain one occurrence of record type EMPLOYEE, and may contain an arbitrary number of occurrences of record types JOB and SKILL.

• **Area.** An area is a named collection of records that need not preserve owner/member relationships. An area may contain occurrences of one or more record types, and a record type may have occurrences in more than one area. A particular record is assigned to a single area and may not migrate between areas.

• **Database.** A database consists of all the records, sets, and areas that are controlled by a specific schema. If a facility has multiple databases, there must be a separate schema for each database. Furthermore, the content of each database is assumed to be independent.

• **Program.** A program is a set or group of instructions in a host language such as COBOL or

FORTRAN. For the purpose of this chapter, a **run unit** is an execution of one or more programs.

Data Manipulation Languages (DMLs)

A data manipulation language (DML) is a language used to cause data to be transferred between a run unit and the database. A DML is not a complete language by itself. It is called a **query language** by some manufacturers. It relies on a host language to provide a framework for it and to provide the procedural capabilities required to manipulate data.

DBMS Events

To depict DBMS events, we selected the READ function. The sequence depicted in figure 3-15 provides a conceptual example of an application

program of a particular software system reading a record. It is intended as a conceptual training aid for instructional purposes only.

The numbered arrows in figure 3-15 trace a call for data by application Program 1 of System A. (Calls for data by other programs maybe handled concurrently by the DBMS, but this is not depicted in the figure.) The following events (numbered to correspond with figure 3-15) take place, depending on the software system in use, when a program attempts to read a record:

1. DML Program 1 of System A makes a call for data from Database (A) to the DBMS.

2. The DBMS analyzes the call and supplements the arguments provided in the call itself with information provided by the schema for Database (A), and the subschema referenced by Program 1.

3. The DBMS obtains the subschema used for System A and retrieves the description of the data in question.

4. The DBMS examines the database physical description and keys the actual physical record to read.

5. On the basis of the call for its services and the information obtained from the schema and subschema, the DBMS requests physical I/O operations, as required to execute the call, from the operating system.

6. The operating system (OS) interacts with the storage media containing the database.

7. The operating system then delivers the requested data from the actual database to the system buffers.

8. The DBMS transfers data, as required to fulfill the call, between the system buffers and the user work area (UWA) of Program 1, which originated the call. Any required data transformations between the representation of the data as it appears in the database (as declared in the schema) and the representation of the data as it appears in a program's UWA (as declared by the subschema) are handled by the DBMS.

The DBMS provides status information to program 1 based on the outcome of its call, for example, error indications. The data in Program 1's UWA may be manipulated as required, using the facilities in the host language. The system buffers are shared by all programs serviced by the DBMS. Remember, programs interact with the system buffers entirely through the DBMS.

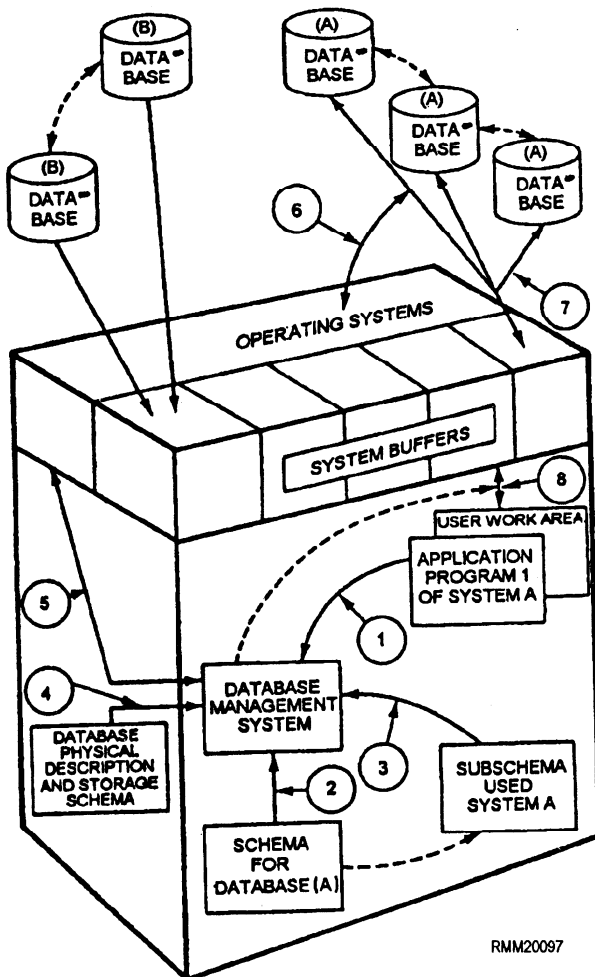

Figure 3-15.—A conceptual view of the events that take place when an application program reads a record in a system interfaced with a DBMS.

Schema DDL and Hardware

A schema DDL entry does not include references to a physical device or media space. Thus, a schema written using a DDL is a description of a database that is not affected by the devices or media used to store the data. The database may, therefore, be stored on any combination of storage media that is supported in a particular DBMS. Because of their sequential nature, some devices, such as magnetic tape, may not take full advantage of the facilities included in a DDL. Such devices are not precluded, however, and may be perfectly adequate for some of the data.

Chances are the DDL you are using will follow the guidelines created by the Conference on Data Systems Languages (CODASYL) and their subcommittee, Data Base Task Group (DBTG). These guidelines have influenced the development of database systems, particularly those for the larger computer systems.

Because of space limitations, the format specifications for a DML and a schema DDL are not presented. The syntax rules for a data description language are similar to those for COBOL and are too technically extensive to include in this chapter. For example, a DDL has a character set, words (programmer supplied), reserved words, key words, names, literal and nonnumeric literal formatting, and many other qualification rules.

Schema/Subschema Data Conversion

Since data description in the subschema is host language oriented, the syntax used in the subschema to describe the characteristics of data items may differ from that in the schema or storage schema. This means that data types that turn out to have the same representation in a given implementation may be described differently in the schema and storage schema than in the subschema. Also, there maybe data types defined in the subschema that have characteristics and representations different from those of any schema type, and vice versa. However, any data item description is eligible for inclusion in a subschema for a particular host language subschema data description entry if one of the following conditions is satisfied in the implementation involved:

- The data item has the same representation both in the database and in the UWA in that implementation,
- A conversion procedure has been provided by the implementor, or

- A conversion procedure has been provided by the database administrator.

The implementor is responsible for defining the correspondence between the schema data types and specifications and the sub schema data types and specifications, in terms of the representation of these respective data types in the implementation. An example of a correspondence that might be established by an implementor would be correspondence between coded arithmetic data in the schema and COMPUTATIONAL data in the COBOL subschema.

The implementor might provide special conversion procedures in addition to those in the DBMS for implementing the conversion rules. An example of a case where the implementor might provide a special conversion procedure would be in the interface between the DBMS and database procedures written in particular host languages. If the DBMS supplies a standard parameter list to database procedures, the representation of some of the parameter values might not match that of any data type in a particular host language. In this case, the implementor might wish to provide a standard conversion procedure to allow the host language to correctly access such values.

Developers of host language database facilities may provide rules defining the intended correspondence between data types allowed in their host language subschema DDL and the data types in the schema DDL. Such rules may be specified directly, naming characteristics of subschema data types so that they can be matched with the characteristics of schema data types. Different host languages may define their rules for intended data type correspondence in terms of the closest schema equivalents; for example, FORTRAN referring to schema TYPE specifications and COBOL referring to schema PICTURE specifications. In this case, the conversion rules specified as part of the schema DDL may be used in determining appropriate conversions involving data types not explicitly mentioned in the host language's defined rules. For example, the COBOL database facility might specify the intended correspondence between its subschema PICTURE specifications and schema PICTURE specifications. With the correspondence between schema and subschema PICTURES established, subschema PICTURE specifications may be interpreted as if they were schema PICTURE specifications. The schema DDL defined conversion rules (which define conversions between schema PICTURES and other schema data types) can then be used to determine appropriate

conversions between subschema PICTURES and any schema data type.

Schema DDL and DML

The relationship between a schema DDL and a DML is the relationship between declaration and procedure. The DDL declarations impose a discipline over the executable code and are to some extent substitutes for procedures written in the DML and the host language.

To specify the relationship between DDL declarations and DML commands, a set of basic data manipulation functions must be defined that is independent of the DML and the host language. Specific commands provided by a particular DML must be resolved into those basic functions. The resolution is defined by the implementor of the DML.

The basic data manipulation functions assumed in these specifications include the functions required to:

- Select records
- Present records to the run unit
- Add new records and relationships
- Change existing records and relationships
- Remove existing records and relationships

Schema and Storage Schema

The concept of separate schema and storage schema allows the separation of the logical description of the entire database from the storage description of the same. This concept is significant from the following points of view:

1. A database administrator may design a schema structure consisting of logical record relationships that sensibly match the totality of applications under implementation or likely to be implemented.
2. Efficiency considerations are separated from the logical description by specifying the storage environment and schema to storage schema mappings in the storage schema. Tuning may be carried out by changing the storage schema without alteration to the schema, subschemas, and programs.

The storage schema describes the representation of stored data in device independent terms. The database may, therefore, be stored on any combination of storage media that is supported by a particular implementation.

The database administrator may allocate media and devices with differing characteristics to suit the command's operational requirements, without alteration to the storage schema.

Database Management System Selection

When selecting a DBMS, the primary consideration should be to select a technology that will support the long-term DBMS needs. The work of identifying the needs of the command should be done in a very careful and thorough manner. The ultimate goal is to make the best choice for the command.

One of the best ways of identifying the needs of the command is to conduct interviews with the users. The results of the interviews will identify areas of concern to them, such as:

- How fast can data be accessed?
- How easy is it to retrieve and manipulate the data?
- How fast and easy is it to develop quality applications?
- Will the redundancy of data be reduced?
- Will it provide for the management and accurate identity of all the data elements?

Once the needs of the command have been identified, it is time to prepare the presentation for management. A first step in the preparation of the presentation is to describe how the needs of the command will be addressed by the DBMS. Develop specific examples to illustrate how each item identified would be handled in the database environment.

After receiving permission from management to continue, you can start the selection process. Since all DBMS software is not the same, you must look at the quality of the product and the ability of the vendor to continue to enhance the product in the future. All of the decisions should be based on the features currently available or in a beta testing environment. The goal is not to find the perfect DBMS, but to identify and recommend the best of those available that will meet the command's needs.

This selection criteria applies whether the DBMS is going to be used on a mainframe computer or a microcomputer system. However, the microcomputer system has a few added concerns that must be met. The most important of these concerns are:

- The capability of receiving downloaded data from a mainframe or another microcomputer
- The ability to be used on a network
- The ability to enable quick and easy setup of screen formats
- The ability to handle a maximum number of records, fields, tables, and so on, and the size of each
- The ability of the software to accept files in multiple formats and to transport files and records out to other microcomputer packages

LOGICAL STRUCTURE OF A DATABASE MANAGEMENT SYSTEM

To decide on the logical structure to use with a DBMS, you will need to first perform a comprehensive review of the data. Determine what data is needed, where the data comes from, and how the data will be used. Look at the reports needed. Find out what transactions and displays are most appropriate for collecting and manipulating the data. At this point, you can determine what programs and queries will need to be developed and decide on the best organization for the data.

The programmer will be the one to decide the organization of the database and to define the physical structures of the database management system. Programs to process the transactions and to generate the anticipated management information and decision support reports are mapped out, using the pseudocode and flowcharts. Once the programs are mapped out, they are written, tested, and implemented, creating the database management system.

SUMMARY

As a communications specialist, you need to know a lot more about computers than just how to operate them. You must have a good working knowledge of computer software. You should be able to explain and demonstrate how to use systems and applications software to both communications specialists and end-user personnel. You will need to interact with the users to determine their requirements and needs. We covered how to determine system software and hardware requirements and the importance of calculating memory requirements. We discussed the parts of a database management system (DBMS) and the selection process for a DBMS, including those for personal computers.

APPENDIX I

GLOSSARY

A

ABORT— Procedure for terminating a program when a mistake, malfunction, or error occurs.

Ada— A high-level programming language designed by the Department of Defense.

ADDRESSING— Locating a required piece of data by specific techniques.

ARITHMETIC-LOGIC UNIT— The part of the cpu that contains the logic capability and performs all the arithmetic functions (addition, subtraction, multiplication, and division).

ARTIFICIAL INTELLIGENCE— The capability of a machine to perform human-like intelligence functions, such as learning, adapting, reasoning, and self-correction.

ASSEMBLER— A computer program that translates assembly language programs into machine language (object) programs.

B

BASIC (Beginners All-Purpose Symbolic Instruction Code)— A high-level, general-purpose programming language used primarily on microcomputers.

BIT MAPPING— A data structure that describes a bit image being held in computer storage.

BUBBLE MEMORY— Method by which information is stored as magnetized dots (bubbles) that rest on a thin film of semiconductor material.

C

C++— An object-oriented version of the C programming language.

CACHE MEMORY— A faster memory in which parts of the information in the main (slower) memory or disk are copied.

CARRIER PACKAGE— The portion of the microprocessor chip that plugs into the motherboard.

CERTIFIER— The piece of equipment that is used to certify magnetic tape and check for errors.

COBOL (Common Business Oriented Language)— A high-level programming language designed for business-type applications.

COMPILER— A program that translates a source program written in a high-level programming language into machine language.

CONTROL MEMORY— RAM consisting of addressable storage registers, primarily used in mini- and mainframe computers.

D

DEGAUSSER— Device used to erase information from magnetically recorded media, such as a floppy disk or magnetic tape.

DIAGNOSTIC LIGHT-EMITTING DIODES— Indicator lights used to help isolate a hardware failure.

DIAGNOSTIC ROUTINE— Routine designed to locate a malfunction in the central processing unit or a peripheral device.

DISTRIBUTED SYSTEM— A computer system designed to operate as a communications network with all its terminals linked to a remotely located central processing unit.

DUPLEX— Pertaining to a communications system or equipment capable of transmission in both directions.

E

EXTERNAL DIAGNOSTICS— Diagnostics that can be run from a peripheral device.

F

FILE FRAGMENTATION— Files that are split into many noncontiguous areas on the disk.

FINITE— To have limits, an end, or a last number.

FIVE-PIN CONNECTOR— A connector that has five pins, usually used to connect a keyboard to the CPU.

FORTRAN (FORmula TRANslator)— A high--level programming language for scientific and mathematical applications.

H

HARD-SECTORED— Wedge-shaped storage division on a floppy disk from time of manufacture.

HIERARCHICAL DIRECTORY— A term used to refer to the organizational method of arranging files either in a DOS tree structure or in the file-and-folder method.

HUB— The center part of the tape reel that attaches to the tape drive.

HYPERTEXT— A document retrieval network having till-text files and dynamic indexes for links among documents.

HYPOTHERMAGRAPH— A piece of equipment that is used to record the temperature and humidity in a computer room.

I

INSTRUCTION AND CONTROL— The portion of the control section that includes the combinational and sequential circuits that make up the decision-making and memory-type functions.

INTEGRATED CIRCUIT— A miniaturized chip in which semiconductor components and other such technology combine the functions of a number of conventional components (such as transistors, resistors, capacitors, and diodes).

INTERNAL DIAGNOSTICS— Diagnostics that are run when the computer is started.

IPL (Initial Program Load)— A set of instructions that cause other instructions (the operating system) to be loaded into the main memory of the computer. This must be done each time the computer is turned on.

J

JULIAN DATE— Form of calendar representation within a computer system, indicating the year and the number of elapsed days in the year.

L

LETTER-QUALITY MODE— The mode that produces high--quality printed output from a printer.

LIBRARIAN— Person responsible for the safekeeping of all computer files, such as diskettes, disk packs, and magnetic tapes.

LOCAL-AREA NETWORK— A network that normally operates within a well-defined and generally self-enclosed area. The communication stations or terminals are linked by cable.

M

MAGNETIC CORE STORAGE— System of storage in which data is represented in binary form by means of directional flow of magnetic fields in tiny, doughnut-shaped arrays of magnetic cores.

MAGNETIC DOMAINS— The data that is stored by changing the polarity of the magnetized dots (bubbles).

MAINFRAME COMPUTERS— This term is usually used to designate large-scale computer systems, although the precise definition of mainframe is the cpu and the control elements of any computer system.

MATRIX— Orderly array of symbols by rows and columns.

MINICOMPUTERS— Midsize computers that are smaller than large-scale systems but with the same components. They are less expensive and have less strict environmental requirements.

MODEM— A device that converts data from digital to analog format for transmission on analog transmission lines, and also converts data in analog format to digital format for computer processing.

MULTIPLE-FILE DIRECTORIES— An option of the operating system that allows for several files to be contained in a directory.

N

NONVOLATILE STORAGE— Storage medium that retains its data in the absence of power.

O

OXIDE— A ferrous material that can be magnetized; also, the recording side of the magnetic tape (dull side).

P

PARALLEL PROCESSING— Handling all the elements of a word or message simultaneously.

PASCAL— High-level structured programming language that has gained wide acceptance as a tool for both applications programming and system development.

PENTIUM CHIP— A processor chip that can execute many instructions at the rate of two instructions per clock cycle.

PERIPHERAL EQUIPMENT— Equipment used for data entry, storage, or retrieval, but which is not part of the central processing unit. Peripherals include crt displays, terminals, printers, and mass storage (tape, disk, and drum) devices.

PHOTOELECTRIC CELL— A mechanism that when activated by a light source emits an electrical impulse.

Q

QUERY— To make a request for information from a database system.

R

RECONCILING— Refers to the correcting of processing discrepancies.

RELATIONAL DATABASE— A database organization scheme that treats files as tables of data in which the rows represent fixed-length records and columns represent fields.

RIGID— Refers to the hard metal platters (usually constructed of aluminum or glass) that comprise a hard disk.

S

SCHEMA— Structure for organizing knowledge relative to context or expectations.

SCRATCHING MAGNETIC MEDIA— Making the magnetic media available to the computer operator for reuse.

SCSI ADAPTER— A general purpose parallel interface designed for connecting one or more computers and one or more peripherals. A total of 8 devices may be connected to one bus.

SEMICONDUCTOR— A crystalline substance that conducts electricity when it is “doped” with chemical impurities.

SERIAL— Pertaining to the sequential occurrence of two or more related activities in a single device.

SILICON CHIP— Tiny portion of a silicon wafer with thousands of electronic components and circuit patterns etched on its surface.

SIMPLEX— A mode of data transmission in which data can travel in only one direction on the line. When a terminal is connected to such a circuit, it can be used to either receive or send data to the cpu but not do both.

SINGLE-FILE DIRECTORIES— An option of the operating system that allows for only one file to be contained in a directory.

SOFT-SECTORED— Method of marking sectors or sections on a disk by using information written on the disk.

SPECIAL FUNCTION KEY— Key on a keyboard to control a mechanical function, initiate a specific computer operation, or transmit a signal that would otherwise require multiple key strokes.

STAND-ALONE— Self-contained computer system that can work independently, not connected to or under the control of another computer system.

STRIPPING— The removing of the first 100 feet of the magnetic tape. This is the portion that becomes contaminated and causes the most errors.

SUBSCHEMA— Logical organization of data required for a particular program.

SURGE PROTECTOR— Device that protects electrical equipment from being damaged by short surges of high voltage by filtering them out.

T

TIMING— The regulation of the flow of signals that control the operation of the computer.

TREE STRUCTURED DIRECTORY— A disk containing a root directory and several subdirectories.

TWENTY-FIVE PIN SERIAL CONNECTOR— A serial connector that has twenty-five pins, usually used for connecting a printer or monitor to the CPU.

U

UNIX— An operating system that has many high-level utility programs; it is capable of running a number of jobs at once.

UNSTRUCTURED DIRECTORY— A disk with only one directory contained on it.

V

VIRUS— A computer program which can wreak havoc on a system, either by destroying data or simply changing and slowing up the processing of the system.

APPENDIX II

GLOSSARY OF ACRONYMS AND ABBREVIATIONS

A

ABEND— Abnormal end of job.

ALCS— Automated library control system.

ALU— Arithmetic/Logic unit.

ATLC— Automated tape library control.

C

CAD— Computer-aided design

CMOS— Complementary metal oxide semiconductor.

CODASYL— Conference on data systems languages.

COOP— Continuity of operations.

CPU— Central processing unit.

D

DASDI— Direct access storage device initialization.

DBMS— Database management system.

DBTG— Database task group.

DDL— Data definition language.

DML— Data manipulation language.

DOS— Disk operating system.

DTP— Desktop publishing.

E

EPROM— Erasable programmable read-only memory.

I

IC— Integrated circuits.

IPL— Initial program loading.

L

LAN— Local--area network.

LQ— Letter quality.

LSI— Large-scale integration.

M

MODEM— Modulator-demodulator.

P

PROM— Programmable read-only memory.

Q

QWERTY— Refers to the letter sequence QWERTY on the keyboard.

R

RAM— Random-access memory.

ROM— Read-only memory.

S

SOP— Standard operating procedure.

SYSRES— System resident.

U

UWA— User work area.

V

VLSI— Very-large-scale integration.

W

WORM— Write once, read many.

WYSIWYG— What you see is what you get.

APPENDIX III

REFERENCES USED TO DEVELOP THIS TRAMAN

NOTE: The following references were current at the time this TRAMAN was published, but you should be sure you have the current editions.

American National Dictionary for Information Processing Systems, Federal Information Processing Standards (FIPS) Publication 11-3, U.S. Department of Commerce, National Bureau of Standards, Washington, DC, 1991.

Banks, Michael, *The Modem Reference*, Second Edition, Brady Publishing, New York, NY, 1991.

Cannon, Don L., Gerald Luecke, *Understanding Microprocessors*, Howard W. Sams and Co., Indianapolis, IN, 1984.

Mueller, Scott, *Upgrading and Repairing PCs*, Fifth Edition, Que® Corporation, Indianapolis, IN, 1995.

Norton, Peter, and Robert Jourdian, *The Hard Disk Companion*, Simon&Schuster, Inc., New York, NY, 1988.

O'Leary, Timothy and Linda, *Microcomputing*, Annual Edition 1994-1995, McGraw-Hill, Inc., New York, NY, 1994.

Prasad, Nallur, Jeffrey Savit, *IBM Mainframes Architecture and Design*, Second Edition, McGraw-Hill, Inc., New York, NY, 1994.

Simon, Alan R., *The Computer Professional's Survival Guide*, McGraw Hill, Inc., New York, NY, 1992.

Spencer, Donald D., Ph. D., *Computer Dictionary*, Fourth Edition, Camelot Publishing, Co., Ormond Beach, FL, 1993.

Wang, W. E., Joe Kraynak, *The First Book of Personal Computing*, Second Edition, SAMS, Prentice Hall Computer Publishing, Carmel, IN, 1990.

INDEX

- A**
- AIS service requests, 2-8
- Applications software, 3-2
- Arithmetic-logic unit, 1-2, 1-3
- Auxiliary storage, 1-6

- B**
- Bit mapping, 1-16

- C**
- Cables, 1-28
- Computer output, 2-2
- Console operations, 2-2
 - booting the system, 2-4
 - computer diagnostics, 2-4
 - console keyboards, 2-3
 - configuration changes, 2-3
 - powering up the system, 2-4
- Control keys, 1-17
- Control panel, 1-22
- Control unit, 1-3

- D**
- Data management, 3-1
- Data transmission methods, 1-9
 - parallel, 1-9
 - serial, 1-9
- Database management systems (DBMS), 3-21
 - data manipulation languages (DMLs), 3-24
 - DBMS events, 3-24
 - schema, 3-22
 - schema data definition language (DDL), 3-23
 - subschema, 3-23
- Database management system selection, 3-26
- Database organization methods, 3-12
 - hierarchical, 3-13
 - list, 3-13
 - network, 3-13
 - relational, 3-14
- Diagnostic/troubleshooting, 1-26
- Diskettes, 1-19
 - care, 2-29
- Documentation, 1-24,2-6
- Duplex, 1-9
 - fill-duplex, 1-9
 - half-duplex, 1-9

- E**
- External labels, 2-11
 - nonpermanent, 2-12
 - permanent, 2-12

- F**
- File and disk management, 2-26
- File fragmentation, 2-34
- File organization, 3-20
 - direct, 3-20
 - indexed sequential, 3-20
 - sequential, 3-20
- Floppies, 1-19

- H**
- Hard disks, 1-20
- Help aides, 1-25
- High-level languages, 3-3
 - ADA, 3-3
 - BASIC, 3-3
 - C++, 3-3

High-level languages—Continued

COBOL, 3-3

FORTRAN, 3-3

PASCAL, 3-3

Hypothermagraph, 2-2

I

Input/output (I/O) channels, 1-9

duplex, 1-9

simplex, 1-9

Input/output devices, 1-14

CD-ROM drive, 1-23

disk drives, 1-18

keyboards, 1-16, 1-28

modems, 1-24

monitors, 1-14, 1-27

mouse, 1-23

optical scanner, 1-23

printers, 1-21, 1-28

switch boxes, 1-24

tape drive, 1-23

I/O and program specifications, 3-20

J

Jobs, 2-5

canceling, 2-6

displaying, 2-5

monitoring, 2-8

restarting, 2-5

starting, 2-5

L

Labels, 2-10

external, 2-11

internal, 2-13

Library environment, 2-22

Library functions, 2-8

care and handling, 2-14, 2-16

cleaning and recertifying, 2-17, 2-19

degaussing, 2-20

destruction, 2-20

disaster/off-site backup, 2-13

labeling magnetic media, 2-10

receipt of magnetic media, 2-10

releasing magnetic media, 2-21

shipment, 2-14

storage, 2-21

Loading and unloading tapes, 2-31

paper forms, 2-32

tapes, 2-31

M

Magnetic disk, 2-16

care and handling, 2-16

cleaning and recertifying, 2-19

Magnetic media administrative duties, 2-24

Magnetic tape, 2-14

care and handling, 2-14

cleaning and recertifying, 2-17

Main memory, 1-3

Management of classified media, 2-23

Memory classifications, 1-5

erasable programmable read-only memory (EPROM), 1-6

programmable read-only memory (PROM), 1-6

random-access memory (RAM), 1-6

read-only memory (ROM), 1-6

Memory types, 1-4

bubble storage, 1-5

magnetic core storage, 1-4

semiconductor storage, 1-4

Messages, 2-4

program-generated, 2-5

system-generated, 2-4

Microprocessor chip, 1-13

Modems, 1-10

Motherboard, 1-12

N

Naming files, 2-26

O

Operating environment, 2-2

P

Peripheral devices, 1-6

- bar-code readers, 1-7
- cathode-ray tube (CRT) terminals, 1-8
- computer consoles, 1-8
- floppy disk drive units, 1-8
- key-to-online data entry terminals, 1-7
- magnetic disk drive units, 1-8
- magnetic ink character readers, 1-7
- magnetic tape units, 1-7
- plotters, 1-9
- printers, 1-8
- scanners, 1-7

Power requirements, 1-26

Primary storage, 1-3

Programming languages, 3-2

- assembly languages, 3-3
- high-level languages, 3-3
- machine languages, 3-2

R

Resolution, 1-15

S

Secondary storage, 1-6

Shift operations, 2-7

Software, 3-3

- database, 3-11
- desktop publishing, 3-15
- Software—Continued
 - spreadsheet, 3-9
 - utilities, 3-17
 - word processing, 3-7
- Software installation, 3-3
 - application, 3-3
 - operating system, 3-3
- Software packages, 3-5
- Special function keys, 1-17
- Specialized processors, 1-14
- Storage area, 1-3
 - input, 1-3
 - output, 1-3
 - program, 1-3
 - working, 1-3
- Storage capacity, 1-19
- Surge protector, 1-27
- System care, 2-30
- System configuration, 1-28
- System software, 3-2
 - assemblers and compilers, 3-2
 - operating systems, 3-2
 - utilities, 3-2
- System unit, 1-11, 1-27

T

Tape retention, 2-26

Trouble reports, 2-1

Troubleshooting, 2-34

U

User requirements, 3-19

- hardware, 3-19
- memory, 3-19
- software, 3-19

Users, 3-5

User/owner manuals, 1-25

Utilities, 3-17

backup, 3-18

desktop organization, 3-18

DOS shells, 3-18

file maintenance, 3-18

Utilities—Continued

file management, 3-18

keyboard enhancement, 3-17

printer, 3-18

virus, 2-8, 3-18

*U.S. Government Printing Office: 1998 - 633-154/60100

RADIOMAN TRAINING SERIES

MODULE 2 - COMPUTER SYSTEMS

NAVEDTRA 12846

Prepared by the Naval Education and Training Professional Development and Technology Center (NETPDTC), Pensacola, Florida

Congratulations! By enrolling in this course, you have demonstrated a desire to improve yourself and the Navy. Remember, however, this self-study course is only one part of the total Navy training program. Practical experience, schools, selected reading and your desire to succeed are also necessary to successfully round out a fully meaningful training program. You have taken an important step in self-improvement. Keep up the good work.

HOW TO COMPLETE THIS COURSE SUCCESSFULLY

ERRATA : If an errata comes with this course, make all indicated changes or corrections before you start any assignment . Do not change or correct the associated text or assignments in any other way.

TEXTBOOK ASSIGNMENTS: The text pages that you are to study are listed at the beginning of each assignment . Study these pages carefully before attempting to answer the questions in the course. Pay close attention to tables and illustrations because they contain information that will help you understand the text. Read the learning objectives provided at the beginning of each chapter or topic in the text and/or preceding each set of questions in the course. Learning objectives state what you should be able to do after studying the material. Answering the questions correctly helps you accomplish the objectives .

SELECTING YOUR ANSWERS: After studying the associated text, you should be ready to answer the questions in the assignment. Read each question carefully, then select the BEST answer. Be sure to select your answer from the subject matter in the text. You may refer freely to the text and seek advice and

information from others on problems that may arise in the course. However, the answers must be the result of your own work and decisions. You are prohibited from referring to or copying the answers of others and from giving answers to anyone else taking the same course. Failure to follow these rules can result in suspension from the course and disciplinary action.

ANSWER SHEETS: You must use answer sheets designed for this course (NETPMSA Form 1430/5, Stock Ordering Number 0502-LP-216-0100) . Use the answer sheets provided by Educational Services Officer (ESO) or you may reproduce the one in the' back of this course booklet.

SUBMITTING COMPLETED ANSWER SHEETS: As a minimum, you should complete at least one assignment per month. Failure to meet this requirement could result in disenrollment from the course. As you complete each assignment , submit the completed answer sheet to your ESO for grading. You may submit more than one answer sheet at a time.

GRADING : Your ESO will grade each answer sheet and notify you of any incorrect answers. The passing score for each assignment is 3.2. If you receive less than 3.2 on any assignment, your ESO will list the questions you answered incorrectly

and give you an answer sheet marked "RESUBMIT." You must redo the assignment and complete the RESUBMIT answer sheet. The maximum score you can receive for a resubmitted assignment is 3.2.

COURSE COMPLETION: After you have submitted all the answer sheets and have earned at least 3.2 on each assignment, your command should give you credit for this course by making the appropriate entry in your service record.

NAVAL RESERVE RETIREMENT CREDIT: If you are a member of the Naval Reserve, you will receive retirement points if you are authorized to receive them under current directives governing retirement of Naval Reserve personnel. For Naval Reserve retirement, this course is evaluated at 5 points. (Refer to BUPERSINST 1001.39 for more information about retirement points.)

STUDENT QUESTIONS: If you have questions concerning the administration of this course, consult your ESO. If you have questions on course content, you may contact NETPDTC at:

DSN: 922-1501
Commercial: (904) 452-1501
FAX: 922-1819
INTERNET:
n311.products@smtp.cnet.navy.mil

COURSE OBJECTIVES: In completing this nonresident training course, you will demonstrate a knowledge of the subject matter by correctly answering questions on the following subjects:

Computer Hardware Startup, Computer Center Operations, and Data Management.

Naval courses may include several types of questions--multiple-choice, true-false, matching, etc. The questions are not grouped by type but by subject matter. They are presented in the same general sequence as the textbook material upon which they are based. This presentation is designed to preserve continuity of thought, permitting step-by-step development of ideas. Not all courses use all of the types of questions available. You can readily identify the type of each question, and the action required, by reviewing of the samples given below.

MULTIPLE-CHOICE QUESTIONS

Each question contains several alternative answers, one of which is the best answer to the question. Select the best alternative, and blacken the appropriate box on the answer sheet.

SAMPLE

- s-1. The first U.S. Navy nuclear-powered vessel was what type of ship?
1. Carrier
 2. Submarine
 3. Destroyer
 4. Cruiser

Indicate in this way on your answer sheet:

	1	2	3	4	
	T	F			
s-1	<input type="checkbox"/>	<input checked="" type="checkbox"/>	<input type="checkbox"/>	<input type="checkbox"/>	---

TRUE-FALSE QUESTIONS

Mark each statement true or false as indicated below. If any part of the statement is false, the entire statement is false. Make your decision, and blacken the appropriate box on the answer sheet.

SAMPLE

- s-2. Shock will never be serious enough to cause death.
1. True
 2. False

Indicate in this way on your answer sheet:

	1	2	3	4	
	T	F			
s-2	<input type="checkbox"/>	<input checked="" type="checkbox"/>	<input type="checkbox"/>	<input type="checkbox"/>	---

Each set of questions consists of two columns, each listing words, phrases or sentences. Your task is to select the item in column B which is the best match for the item in column A. Items in column B may be used once, more than once, or not at all. Specific instructions are given with each set of questions. Select the numbers identifying the answers and blacken the appropriate boxes on your answer sheet.

SAMPLE

In answering questions s-3 through s-6, SELECT from column B the department where the shipboard officer in column A functions. Responses may be used once, more than once, or not at all.

- | | |
|------------|---------------|
| A. OFFICER | B. DEPARTMENT |
|------------|---------------|

- | | |
|-------------------------------|---------------------------|
| s-3. Damage Control Assistant | 1. Operations Department |
| s-4. CIC Officer | 2. Engineering Department |
| s-5. Disbursing Officer | 3. Supply Department |
| s-6. Communications Officer | 4. Navigation Department |

Indicate in this way on your answer sheet:

	1	2	3	4	
	T	F			
s-3	<input type="checkbox"/>	<input checked="" type="checkbox"/>	<input type="checkbox"/>	<input type="checkbox"/>	---
s-4	<input checked="" type="checkbox"/>	<input type="checkbox"/>	<input type="checkbox"/>	<input type="checkbox"/>	---
s-5	<input type="checkbox"/>	<input type="checkbox"/>	<input checked="" type="checkbox"/>	<input type="checkbox"/>	---
s-6	<input checked="" type="checkbox"/>	<input type="checkbox"/>	<input type="checkbox"/>	<input type="checkbox"/>	---

ASSIGNMENT 1

Textbook Assignment: "Computer Hardware Startup," chapter 1, pages 1-1 through 1-25.

- 1-1. The central processing unit of a digital computer is made up of a central control section and work areas that are needed to perform calculations and manipulate data. What are the names of the sections within the CPU?
1. Control, internal storage, and arithmetic-logic
 2. Control, working storage, and programming storage
 3. Internal storage, arithmetic-logic, and working-storage
 4. Arithmetic-logic, input/output storage, and internal storage
- 1-2. Within the CPU, what section maintains order and directs the flow of operations and data?
1. Logic
 2. Control
 3. Program storage
 4. Internal storage
- 1-3. Within the CPU, the internal storage section normally contains which of the following storage areas?
1. Input and output only
 2. Output and program only
 3. Input, program, and working only
 4. Input, output, program, and working
- 1-4. What type of memory allows you to read data from or write data into it just by giving the computer the address of the location where the data is stored or is to be stored?
1. ROM
 2. RAM
 3. PROM
 4. EPROM
- 1-5. Most computers can permanently store often used instructions, such as those used to boot-strap the computer, in memory. What type of memory makes this possible?
1. Permanent
 2. Read-only
 3. Inaccessible
 4. Programmable
- 1-6. What type of storage (memory) allows you to enter any program you desire, but once the memory has been written into, it can never be altered or changed?
1. ROM
 2. RAM
 3. PROM
 4. EPROM

- 1-7. Which of the following types of storage is normally outside the main body of the computer and is used to store programs and data for future use?
1. Map storage
 2. Hyper storage
 3. Secondary storage
 4. Peripheral storage
- 1-8. Anytime an input or output device is under the direct control of the CPU, we say the device is in what mode?
1. Online
 2. Offline
 3. Stand-by
 4. Parallel
- 1-9. Which of the following components is NOT considered an input/output (I/O) device?
1. Computer terminal
 2. Scanners
 3. Floppy disks
 4. Magnetic tape unit
- 1-10. Whether an I/O channel is input only, output only, or both input and output is determined by what person or primary factor?
1. The systems analyst
 2. The maintenance programmer
 3. The design of the CPU itself
 4. The specific type of peripheral device
- 1-11. An I/O channel that is capable of communicating in both directions but in only one direction at a time is what type of channel?
1. Half-duplex
 2. Full-duplex
 3. Half-simplex
 4. Simplex
- 1-12. Under full-duplex I/O channel operations, communications are possible in which of the following directions?
1. From the computer to the terminal only
 2. From the terminal to the computer only
 3. In both directions simultaneously
 4. In both directions, one direction at a time
- 1-13. When data is transmitted over a communications channel in a serial fashion, the data is sent or received in which of the following forms?
1. Bits
 2. Words
 3. Records
 4. Characters
- 1-14. Which of the following devices is used to convert a digital signal produced by your terminal to an audio signal suitable for transmission over a communication line?
1. A line conditioner
 2. A signal generator
 3. A modulator-demodulator
 4. An analog-to-digital simulator

1-15. What microcomputer unit processes the data, performs arithmetic and logic functions, and maintains control of the system?

1. RAM
2. System unit
3. Display unit
4. Hard disk drive

1-16. The disk controller board, video board, and input/output boards are plugged into what board?

1. Memory
2. System
3. Mother
4. Serial/parallel

1-17. Microprocessor chips contain what three types of circuitry?

1. Memory, control logic, and instruction decoding
2. Memory, instruction decoding, and arithmetic-processing
3. Operating system, control logic, and arithmetic-processing
4. Control logic, instruction decoding, and arithmetic-processing

1-18. The system board (mother board) contains which of the following types of chips?

1. RAM and ROM only
2. RAM, ROM, and I/O integrated chips only
3. I/O integrated circuit chips and microprocessor chip(s) only
4. RAM, ROM, I/O integrated chips, and microprocessor chip(s)

1-19. Compared with a computer that processes 8 bits at a time, a computer that handles 32 bits at a time has which of the following advantages?

1. Processes program instructions faster
2. Can accommodate a larger primary memory
3. Both 1 and 2 above
4. Can accommodate a modem

IN ANSWERING QUESTIONS 1-20 THROUGH 1-22, SELECT THE DESCRIPTION IN COLUMN B THAT MATCHES THE MICROCHIP LISTED IN COLUMN A.

	<u>A. CHIPS</u>	<u>B. DESCRIPTIONS</u>
1-20.	8086	1. 8-bit
1-21.	8088	2. 16-bit
1-22.	386DX	3. 32-bit
		4. Hybrid

- 1-23. What type of chip is the 80287?
1. RAM
 2. DOS
 3. I/O circuit
 4. Math coprocessor
- 1-24. Which of the following terms is NOT used interchangeably with the term monitor?
1. Display
 2. System unit
 3. Display device
 4. Cathode-ray tube
- 1-25. Most color monitors are of the RGB type. What does RGB mean?
1. Red-green-blue
 2. Red-gold-blue
 3. Raster gauge beam
 4. Registered global beam
- 1-26. Depending on the amount of RAM available, color monitors can display what range of colors?
1. 8 to 256
 2. 16 to 256
 3. 8 to 16,000,000
 4. 16 to 16,000,000
- 1-27. Most monitors will have an LED indicator light. What does LED mean?
1. Light-emitting diode
 2. Light-enhancing diode
 3. Low-emitting device
 4. Low-enhancing device
- 1-28. What characteristic determines the sharpness of the monitor screen image?
1. Color
 2. Resolution
 3. Refraction
 4. Screen size
- 1-29. The number of dots or pixels per square inch of screen measures what characteristic?
1. Color
 2. Refraction
 3. Resolution
 4. Screen size
- 1-30. A screen with a resolution of 1280 by 1024 has what total number of pixels?
1. 1, 024
 2. 1,280
 3. 2,304
 4. 1,310,720
- 1-31. By what means are characters created on the screen?
1. Dot-matrix
 2. Dot mapping
 3. Line drawings
 4. Opaque images
- 1-32. To individually control each dot or pixel on a display screen, what technique can be used?
1. Dot display
 2. Bit display
 3. Dot mapping
 4. Bit mapping

1-33. Having a display device that can automatically switch to any standard graphics card allows you to take which of the following actions?

1. Upgrade the graphics board without upgrading the display unit
2. Use any graphics package regardless of operating system
3. Perform system and display diagnostics more rapidly
4. Each of the above

1-34. What is the function of the keyboard?

1. To receive output from the microcomputer
2. To input data into the microcomputer only
3. To input programs into the microcomputer only
4. To input data and programs into the microcomputer

1-35. In addition to alphabetic characters, numbers, and special characters, keyboards have what other types of keys?

1. Control only
2. Function only
3. Control and function
4. Operation

1-36. What key usually stops the execution of an operation or function?

1. Escape
2. Delete
3. Return
4. Control

1-37. Keys can be combined to perform special functions. For example, pressing the CTRL, ALT, and DEL keys at the same time on most IBM compatible personal computer systems would have what result?

1. Reboot the operating system
2. Load a new applications program
3. Display a help screen
4. Store the file displayed on the screen

1-38. To tell the computer you have entered data or instructions and are ready to have them processed, you should press what key(s)?

1. Tab only
2. Ctrl and Tab
3. Ctrl and Alt
4. Enter/return

1-39. Function keys F1-F10 are specifically designed for what purpose?

1. To provide standard information to all programs
2. To control cursor placement on the screen
3. To be defined by each program for its own use
4. To allow changing the size of the characters displayed on the screen

- 1-40. What are the functions of the left and right arrow keys?
1. To move the cursor one position left or right, respectively
 2. To move the cursor one line up or down, respectively
 3. To insert a character to the left or right of the position of the cursor, respectively
 4. To delete the character to the left or right of the cursor, respectively
- 1-41. Which of the following types of keys are examples of control keys?
1. F1 through F10
 2. Print screen, delete, and insert
 3. Numbers and special characters
 4. Alternate, space bar, and enter/return
- 1-42. Which of the following types of keys are examples of special function keys?
1. Cursor control
 2. Tab and control
 3. Letters and numbers
 4. Space bar and back space
- 1-43. Which of the following properties is NOT a characteristic of a disk?
1. Flat
 2. Round
 3. Direct access
 4. Sequential access
- 1-44. Diskettes are also known by which of the following terms?
1. Floppy disk
 2. Read-only disk
 3. Write-only disk
 4. Hard disk
- 1-45. Diskettes come in which of the following sizes, in inches?
1. 3 and 5
 2. 3 1/4 and 5
 3. 3 and 5 1/4
 4. 3 1/2 and 5 1/4
- 1-46. The index hole on a diskette serves which of the following purposes, if any?
1. Marks the first sector of the diskette
 2. Indicates the front side of the diskette
 3. Indicates the back side of the diskette
 4. None
- 1-47. When software controls sector timing of diskettes, (a) what sector type is being used, and (b) which of the following numbers of timing holes are required on the diskette?
1. (a) Hard-sectored
(b) One only
 2. (a) Hard-sectored
(b) Several
 3. (a) Soft-sectored
(b) One only
 4. (a) Soft-sectored
(b) Several

- 1-48. What is the purpose of a formatter program, routine, or command?
1. To sector a soft-sectored diskette
 2. To create file labels on a diskette
 3. To establish a naming pattern for writing files on a diskette
 4. To set up a routine to be used to read a diskette that already contains files
- 1-49. A diskette that can be written on both sides and can hold 512 bytes of information in each sector is what type of diskette?
1. Dual-sided, single-density
 2. Dual-sided, double-density
 3. Double-sided, single-density
 4. Double-sided, double-density
- 1-50. You want to prevent data from being written on a diskette. What should you usually do to the write-protect notch if you are using a (a) 5 1/4-inch diskette and a (b) 3 1/2-inch diskette?
1. (a) Cover it
(b) uncover it
 2. (a) Cover it
(b) uncover it
 3. (a) Uncover it
(b) cover it
 4. (a) Uncover it
(b) uncover it
- 1-51. Rigid metal platters contained in a small sealed unit either within the system unit or external to it are called what type of disk drive?
1. Colt
 2. Winchester only
 3. Hard disk only
 4. Winchester or hard disk
- 1-52. Speed, large storage capacities, and convenience are all advantages of which of the following storage media?
1. Diskettes
 2. Hard disks
 3. Paper tape
 4. Magnetic tapes
- 1-53. Printers used with microcomputers usually have which of the following speeds and print characters in what manner?
1. Low speed, one character at a time
 2. Low speed, one line at a time
 3. High speed, one character at a time
 4. High speed, one line at a time
- 1-54. Which of the following types of nonimpact printers can be used for both printing and plotting?
1. Laser
 2. Ink jet
 3. Electrostatic
 4. Electrosensitive

- 1-55. Control panels allow you to select various settings on a printer. What is the purpose of a form-feed button?
1. To eject paper from the printer
 2. To advance the paper to the top of the next form
 3. To allow you to select reprinted forms
 4. To advance the paper 1 1/2 inches
- 1-56. Before a printer can print, the indicator lights must be in which of the following conditions?
1. The power light on, the online light off, and the error light off
 2. The power light on, the offline light on, and the error light on
 3. The power light on, the online light on, and the error light off
 4. The power light on, the offline light on, and the error light off
- 1-57. To freehand sketch or to select items from menus on a display screen, you use what device?
1. Cat
 2. Mouse
 3. Modem
 4. Optical scanner
- 1-58. CD-ROM uses a technology called WORM. What does WORM mean?
1. Write or read many
 2. Write once, read many
 3. Write or read memory
 4. Write once, read memory
- 1-59. A cable that allows devices to communicate without modems and phone lines is called a
1. convert cable
 2. phone cable
 3. null modem cable
 4. connector cable
- 1-60. To find out how to install or configure a piece of hardware, you should use what reference source?
1. User/owner's manual
 2. Diagnostics manual
 3. Training manual
 4. Textbook
- 1-61. Which of the following sections is NOT contained in the manuals that come with a system or the software?
1. Reference
 2. Error messages
 3. Troubleshooting
 4. Standard operating procedures

1-62. You should look at the headings in the table of contents and browse the appendices, glossary, and index of a manual for which of the following reasons?

1. To get an idea of what information the manual contains only
2. To see how the information is organized only
3. To get an idea of what information the manual contains and how it is organized
4. To decide whether to buy additional copies

1-63. Online tutorials that come with software packages usually have which of the following purposes?

1. To teach all the commands of the software
2. To give you an overview of what the software can do and how it works
3. To drill you in keying the correct information for specific applications
4. To help you memorize all the functions and special commands

1-64. Keyboard templates and reference cards are useful because they provide which of the following information?

1. Detailed instructions about each feature
2. Identification of features and associated keystrokes
3. Keyboard schematic with a detailed description of each key and all its functions
4. Keyboard schematic with the ASCII coding associated with each key

1-65. In-house user manuals have which of the following functions?

1. To implement command policy only
2. To implement command procedures only
3. To implement command policy and procedures
4. To implement security regulations only

ASSIGNMENT 2

Textbook Assignment: "Computer Hardware Startup (continued)," chapter 1, pages 1-26 through 1-29; "Computer Center Operations," chapter 2, pages 2-1 through 2-35; "Data Management," chapter 3, pages 3-1 through 3-6.

- 2-1. Which of the following devices, if any, gets its power supply from the system unit rather than through its own power line cable?
1. Printer
 2. Keyboard
 3. Monitor
 4. None
- 2-2. High voltage can overload and literally burn up the computer's internal components. To avoid high voltage peaks, you should use what device?
1. Mouse
 2. Fuse box
 3. Surge protector
 4. Gender changer
- 2-3. What device has a cable with a twenty-five pin serial connector to connect it to the system unit?
1. Monitor
 2. Keyboard
 3. Printer
 4. Surge protector
- 2-4. Which of the following types of devices can usually operate in either a serial or a parallel mode?
1. Keyboards
 2. Monitors
 3. Printers
 4. Surge protectors
- 2-5. What is the criteria for submitting a trouble report?
1. There is a problem with hardware that you cannot correct
 2. There is a problem with software that you cannot correct
 3. Both 1 and 2 above
 4. The system is completely down
- 2-6. Computer rooms preset temperatures to prevent equipment failures. Regardless of temperature requirements, which of the following temperature ranges is most often maintained in computer rooms?
1. 60°F - 65°F
 2. 65°F - 70°F
 3. 70°F - 75°F
 4. 75°F - 80°F
- 2-7. What instrument is used to monitor both temperature and humidity in a computer space?
1. Hygrometer
 2. Barometer
 3. Thermometer
 4. Hypothermograph
- 2-8. What type of distinctive function keys, provided by the manufacturer, provide faster and easier performance of routine functions?
1. Special
 2. Command
 3. Programmable
 4. Atypical

- 2-9. When powering up a computer you should power up the CPU first, then each piece of equipment individually for which of the following reasons?
1. To save time
 2. To save power
 3. To prevent a surge of power
 4. To verify all the indicator lights are working
- 2-10. As a computer console operator, you normally have to reboot (IPL) the computer system after each of the following conditions except which one?
1. The system has lost power
 2. The system has gone into a wait state
 3. The system is shut down for repairs
 4. The system is disabled due to a system crash
- 2-11. Some mainframe computers use a disk to store their operating system. This disk is known by which of the following names?
1. DISKMAIN
 2. MAINSYS
 3. PACSYS
 4. SYSRES
- 2-12. What are the two types of computer diagnostics?
1. Internal and external
 2. Internal and booted
 3. External and peripheral
 4. External and selected
- 2-13. As a computer console operator, you are responsible for responding to messages from the computer. Basically, you are concerned with what two types of messages?
1. Program and control
 2. User and applications
 3. System and conditional
 4. Operating system and program generated
- 2-14. As a computer console operator, you can determine if a job is active, stopped, terminated, or waiting for printer by performing which of the following console functions?
1. Initiating job log
 2. Displaying job status
 3. Querying job queue
 4. Displaying master scheduler
- 2-15. Normally, the programmer determines the points in a program where a job can be restarted without having to rerun the entire job. These points are known by what term?
1. Program checks
 2. Checkpoints
 3. Branchpoints
 4. Cutoff points
- 2-16. When a program is cancelled or terminates abnormally, it is said to have
1. ABENDED
 2. ABANDONED
 3. ERROR STOPPED
 4. JOB HALTED/STOPPED

- 2-17. When a program abnormally terminates, you will normally be required to dump the contents of storage for which of the following reasons?
1. To save space on the storage media
 2. To allow for reconstruction of the input data
 3. To help the programmer analyze the program
 4. To clear out the problem area that caused the abnormal termination
- 2-18. What is/are the main reason(s) for relieving a shift 15 to 30 minutes early?
1. Get acquainted with the jobs running
 2. Provide constancy between shifts
 3. Provide continuity between operators
 4. All of the above
- 2-19. If a job terminates before going to a normal EOJ, you, as the I/O control clerk, may be required to collect which of the following data/information?
1. Output data and memory dump only
 2. Input data and SCL statements only
 3. Input data, output data, and memory dump
 4. Output data, console printout, and SCL statements
- 2-20. What makes up a basic virus?
1. A malicious program segment that leaves no obvious signs of its presence
 2. Complex instructions that have been designed to stop your computer system from booting up
 3. A malicious program segment that creates obvious signs of its presence
 4. Complex instructions that cause the peripheral devices to log on and off by themselves
- 2-21. Magnetic tape must be acclimated to the atmosphere in which it will be used for what minimum period of time?
1. 6 hours
 2. 12 hours
 3. 18 hours
 4. 24 hours
- 2-22. A media librarian is NOT expected to perform which of the following tasks?
1. Maintain off-site storage tapes and disks for disaster recovery
 2. Maintain control of data files, program files, and various types of microforms
 3. File all library materials in a neat, organized, and uniform manner
 4. Make necessary SCL program changes prior to releasing jobs from the library

- 2-23. What is the total number of 90-day extensions that may be granted before the tape is copied to another tape?
1. One
 2. Two
 3. Three
 4. Four
- 2-24. What person is responsible for updating fire-fighting instructions and ensuring fire-fighting equipment is maintained in the magnetic media library?
1. Media librarian
 2. Local fire marshal
 3. Damage control petty officer
 4. Computer operations supervisor
- 2-25. As media librarian, you have just removed a new tape from the shipping container. Which of the following factors or actions ensures that nothing is internally wrong with the tape?
1. The protective covering is still on the tape
 2. The warranty of the manufacturer is in effect
 3. Verification of the tape with a tape cleaner/certifier
 4. Visual inspection of the shipping container, looking for physical damage
- 2-26. What are the two types of labels used for magnetic media?
1. Internal and EOF
 2. Internal and external
 3. External and media
 4. External and BOF
- 2-27. As media librarian, you are NOT responsible for the initial preparation of which of the following tape labels?
1. Save
 2. Usage
 3. Certification
 4. Identification
- 2-28. Which of the following labels remains on a magnetic tape throughout its life cycle?
1. Save
 2. Usage
 3. Program
 4. Identification
- 2-29. On magnetic tape, what is the purpose of the usage label?
1. It indicates how often a tape is to be certified
 2. It helps to identify what has been previously written on the media
 3. It contains information that helps to identify the job or task number
 4. It indicates the number of times a tape has been read from or written to
- 2-30. When using internal labeling, how many blocks of information, if any, are written immediately after the BOT marker?
1. Five
 2. Two
 3. Six
 4. None

- 2-31. Which of the following is a good tape handling practice?
1. Store magnetic tape in a horizontal position
 2. Stack tapes with wrap-around straps in stacks of 20
 3. Carry magnetic tape by the center hub, never the flanges
 4. Using both hands, mount tape by applying an even amount of pressure to the outer flange
- 2-32. Whenever you are retrieving, storing, or handling a disk pack, you should always carry it in which of the following ways?
1. By the handle located on the top cover
 2. By the handle located on the bottom cover
 3. By placing both hands on the bottom cover
 4. Under your arm, so it will not get away from you
- 2-33. When you are working with magnetic tape, the greatest number of tape errors are normally found in what area of the tape?
1. Within the feet
 2. Within the
 3. In the middle of the tape
 4. On the edges of the tape
- 2-34. A new tape should be cleaned (a) a minimum of how many times, and (b) for what reason?
1. (a) One
(b) to relieve tape packing
 2. (a) One
(b) to help prevent head wear
 3. (a) Two
(b) to relieve tape packing
 4. (a) Two
(b) to help prevent head wear
- 2-35. When you are cleaning a tape, (a) what is used to remove protrusions from the oxide surface, and (b) what is the maximum percentage of tape errors that are removed?
1. (a) Knives
(b) 75%
 2. (a) Wiping assemblies
(b) 75%
 3. (a) Knives
(b) 90%
 4. (a) Wiping assemblies
(b) 90%
- 2-36. Soft data checks are also called what type of errors?
1. Permanent
 2. Temporary
 3. Hard parity
 4. Head-to-disk contact

- 2-37. What action does the degaussing of magnetic media accomplish?
1. Sorts out individual bits
 2. Rearranges all alphabetic and numeric characters
 3. Magnetically saturates the oxide coating and rearranges all 0 and 1 bits
 4. Demagnetizes the media and then replaces EOT and BOT markers with up-to-date labels for reuse
- 2-38. What guidelines, if any, do you use to destroy magnetic tape and diskettes?
1. Local SOPS
 2. OPNAVINST 5530.14
 3. SECNAVINST 5233.1
 4. None
- 2-39. Most AIS installations have incorporated or are capable of installing an automated tape library control (ATLC) system. Which of the following processes takes place in an ATLC system?
1. Save labels are automatically scanned by an optical reader
 2. Storage, handling, and retrieval of magnetic media are done automatically
 3. Tape/disk files are automatically saved, retained, and scratched, based on purge dates
 4. Information needed to build an ATLC master record is automatically extracted from the media's internal label
- 2-40. Under an ATLC system, what report indicates the tapes that are to be scratched or released?
1. The library maintenance report
 2. The media to be released report
 3. The user/programmer report
 4. The applications report
- 2-41. The diskette should be inserted in a horizontal diskette drive with (a) the label and (b) the recording window facing in which of the following directions?
1. (a) Up
(b) toward the drive door
 2. (a) Up
(b) away from the drive door
 3. (a) Down
(b) toward the drive door
 4. (a) Down
(b) away from the drive door
- 2-42. What is the extension of a file named DIAG-A.89?
1. DIAG
 2. A.89
 3. 89
 4. A
- 2-43. When you display a tree-structured directory on a monitor screen, what notation identifies subdirectories?
1. <DIR>
 2. <B/S>
 3. <BDIR/S>
 4. SUB as an extension

- 2-44. What command is used to instruct DOS to create a directory?
1. CD
 2. CHDIR
 3. DIR
 4. MKDIR
- 2-45. To move through a tree-structured directory, you must issue commands that use what name?
1. Branch name
 2. Trunk name
 3. Path name
 4. Leaf name
- 2-46. You run the risk of losing data and programs stored on disk if you do not take which of the following actions?
1. Make backup copies
 2. Enter security codes in the file name
 3. Assign a volume number and name to each disk
 4. Use subdirectories to store similar data and programs
- 2-47. Which of the following actions, if any, can you take to help prevent data loss and extend the life of floppy disk drives?
1. Perform diagnostic routines periodically to see if there are any problems
 2. Clean floppy disk drives with a head cleaning diskette
 3. Clean the floppy disk drives with a cleaning solution on a soft cloth
 4. None
- 2-48. When you load or unload a tape from a tape drive, which of the following conditions should you look for?
1. Reel warpage
 2. Tape protruding
 3. Irregular winding
 4. All of the above
- 2-49. Assume you have mounted a tape on tape unit 2 and notice that during the loading phase the tape is wobbling. Which of the following conditions could cause this problem?
1. The tape tension is uneven
 2. The drive capstans are not properly aligned
 3. The file protect ring is not completely inserted
 4. The volume of air in the vacuum columns is low
- 2-50. When you adjust the tractors on a printer, it is good practice to keep which of the following tractors in one permanent location?
1. Upper tractors
 2. Lower tractors
 3. Left-hand tractors
 4. Right-hand tractors
- 2-51. On a printer, the paper thickness control knob has a direct effect on which of the following printer functions?
1. Forms stacking
 2. Quality of print
 3. Alignment of preprinted forms
 4. Line-by-line movement of paper

2-52. Your system will probably provide a read disk test, a keyboard test, and a power-up test. These types tests are characterized by what term?

1. Offline routines
2. Diagnostic routines
3. Operator maintenance
4. Corrective maintenance

2-53. Software that is specifically designed to coordinate the capabilities of the computer itself is called what type of software?

1. Systems
2. Computer
3. Scheduling
4. Operations

2-54. Programs that are designed to solve individual user problems are called what type of programs?

1. CDA
2. General
3. Privileged
4. Applications

2-55. When you write a program, which of the programming language categories listed below would be the most time consuming?

1. COBOL
2. FORTRAN
3. Machine
4. Assembly

2-56. There are a whole host of high-level programming languages. Which of the following languages was designed with the professional programmer in mind?

1. Ada®
2. C++
3. COBOL
4. FORTRAN

NOTE : Ada is a registered trademark of the U.S. Department of Defense.

2-57. All microcomputer systems will have at least what type of software?

1. A window program
2. An operating system
3. A word processing package
4. A data base management system

2-58. Which of the following types of information must you provide to an applications software package when you install it on a microcomputer system?

1. Microcomputer configuration information
2. Examples of the work that will be performed
3. Lists of outputs you want on a scheduled basis
4. All of the above

2-59. To make a microcomputer system easier for the user to start each day, you should take what action?

1. Give the user a written list of specific instructions to follow
2. Set the system to automatically boot when the user turns on the power
3. Go to each system each morning and boot the system for the user
4. Make arrangements for one person in each functional area to boot all the systems each day

- 2-60. Before turning the power off on a microcomputer system, the user should take which of the following actions?
1. Save his/her work
 2. Exit the program to return to the operating system
 3. Park the read/write heads if using a hard drive
 4. Deenergize the system
- 2-61. Packaged software does NOT include which of the following software?
1. Database
 2. Word processing
 3. Job control
 4. Spreadsheet
- 2-62. Regardless of the software package you are using, it is NOT mandatory that you be capable of executing which of the following operations?
1. Access and execute the software
 2. Save files
 3. Delete files
 4. Run diagnostics
- 2-63. To perform file management functions effectively, you must know which of the following facts about files?
1. How they are set up and coded
 2. How they are named
 3. How they are backed up
 4. All of the above
- 2-64. When you are learning how to use a software package, you should NOT take which of the following actions?
1. Take the tutorial/study the learning section
 2. Create a test file and practice on it
 3. Practice on the master data file
 4. Make mistakes on purpose to see how the software handles operator/user errors
- 2-65. Commands composed of words and/or characters predefined by the software to perform specific tasks are what type of commands?
1. Direct
 2. Indirect
 3. Execute
 4. Job
- 2-66. Function keys have which of the following purposes?
1. To perform user defined functions only
 2. To perform commonly used commands without the user having to type the command
 3. To provide user status information only
 4. To enter data and program information

ASSIGNMENT 3

Textbook Assignment: "Data Management (continued)," chapter 3, pages 3-6 through 3-27.

- 3-1. When you are learning a new software package, what method of interfacing with the software is usually the easiest?
1. Menu
 2. Direct commands
 3. Function keys
 4. Programs/macros
- 3-2. Use of what feature(s) enables you to enter and save a series of keystrokes for later use?
1. Function keys
 2. System commands
 3. Job languages
 4. Macro capability
- 3-3. Macros can be developed and stored to perform which of the following types of tasks?
1. Repetitive only
 2. Complex only
 3. Awkward only
 4. Repetitive, complex, and awkward
- 3-4. What type of software package is designed primarily to work with documents?
1. Word processing
 2. Spreadsheet
 3. Graphics
 4. Database
- 3-5. What is the usual method of entering a document?
1. Type it on a keyboard
 2. Receive it over a network
 3. Input it through a scanner
 4. Import it from a desktop publishing program
- 3-6. Once entered, a document is normally stored as a data file in what way, if at all?
1. In RAM
 2. In ROM
 3. On a secondary storage medium
 4. None; documents are only printed, not stored
- 3-7. You are using a word processing program and want to add new material to a document. What mode of operation should you use?
1. New
 2. Add
 3. Insert
 4. Typeover
- 3-8. What feature of word processing enables you to continue typing without regard for where a line ends?
1. Word wrap
 2. Hyphenation
 3. End around
 4. Automatic return

- 3-9. To underline or center material, you should use what feature?
1. Cursor movement key
 2. Direct command
 3. Function key
 4. Macro
- 3-10. Usually, a dictionary is included with which of the following software?
1. Database
 2. Spreadsheet
 3. Word processing
 4. Desktop publishing
- 3-11. What type of software package works in columns and rows?
1. Database
 2. Spreadsheet
 3. Graphics
 4. Desktop publishing

	A	B	C	D
1	<u>ITEM</u>	<u>QUANTITY</u>	<u>COST</u>	<u>TOTAL\$</u>
2	Tapes	10	27.50	275.00
3	Disks	4	350.00	1400.00

Figure 3A

IN ANSWERING QUESTIONS 3-12 THROUGH 3-16, REFER TO FIGURE 3A.

- 3-12. What total number of data cells are shown?
1. 7
 2. 12
 3. 3
 4. 4
- 3-13. What value is shown in data cell B3?
1. 27.50
 2. 10
 3. 350.00
 4. 4

- 3-14. The values in the total column are calculated by the software by the user specifying a formula to perform what calculation, if any?
1. Column B times column C
 2. Column B plus column C
 3. Column C squared
 4. None
- 3-15. If you need to change the quantity of tapes and recalculate the cost, which data cells would you have to change from the keyboard?
1. B2 only
 2. B2 and C2 only
 3. B2 and D2 only
 4. B2 , C2, and D2
- 3-16. In the spreadsheet, (a) what term is used to describe the entries in column A, and (b) what type of data does column A contain?
1. (a) Labels
(b) numeric
 2. (a) Labels
(b) nonnumeric
 3. (a) Values
(b) numeric
 4. (a) Values
(b) nonnumeric

- 3-17. Which of the following names is/are also used to describe a spreadsheet?
1. Array only
 2. Matrix only
 3. Worksheet only
 4. Array, matrix, and worksheet

- 3-18. What type of software packages work primarily with records, fields, indexes, pointers, and keys?
1. Graphics
 2. Database
 3. Spreadsheet
 4. Word processing
- 3-19. To access records in a database in a sequence other than the sequence in which they are stored, you can use which of the following techniques?
1. Indexes
 2. Pointers
 3. Directories
 4. Key searches
- 3-20. List databases use what technique to link records?
1. Indexes
 2. Pointers
 3. Catalogs
 4. Directories
- 3-21. What type(s) of database structure link(s) related data elements by using superior-subordinate relationships?
1. Network only
 2. Hierarchical only
 3. Hierarchical and network
 4. Relational
- 3-22. What type of database structure enables the user to establish relationships when requesting information rather than requiring relationships be established at the time the structure is defined?
1. List
 2. Network
 3. Relational
 4. Hierarchical
- 3-23. With database software, what name is given to the type of language used to retrieve information from a database?
1. Query
 2. System
 3. Information
 4. Report generator
- 3-24. When you want to produce a high quality printed document with a variety of type sizes and styles, what type of software package would be best to use?
1. Word processing
 2. Desktop publishing
 3. Graphics
 4. Database
- 3-25. When you want to use desktop publishing software to process a document you created with word processing software, you will have to take what action?
1. Import the document file
 2. Rekeystroke the document
 3. Reformat the document file using a stand-alone utility program
 4. Translate the document file using a stand-alone utility program
- 3-26. Which of the following is NOT a function of desktop publishing software?
1. Composition
 2. Calculations
 3. Graphics
 4. Layout

- 3-27. Layout involves which of the following tasks?
1. Arranging text only
 2. Drawing borders only
 3. Incorporating illustrations only
 4. Arranging text, drawing borders, and incorporating illustrations
- 3-28. The space added between lines of material is known by what term?
1. Letter spacing
 2. Gutter spacing
 3. Clipping
 4. Leading
- 3-29. You can expect to find which of the following capabilities relating to graphics in a desktop publishing program?
1. Resizing only
 2. Importing only
 3. Color layering only
 4. Resizing, importing, and color layering
- 3-30. At a minimum, to effectively use desktop publishing software requires which of the following processors?
1. A 286 16-bit
 2. A 386 16-bit
 3. A 486 16-bit
 4. A Pentium 32-bit
- 3-31. The monitor to use with desktop publishing software should have (a) what resolution and (b) at least what size screen?
1. (a) High (b) 13-inch
 2. (a) High (b) 19-inch
 3. (a) Low (b) 13-inch
 4. (a) Low (b) 19-inch
- 3-32. What type of printer is best to use with desktop publishing?
1. Daisy wheel
 2. Dot-matrix
 3. Laser
 4. Band
- 3-33. Software utilities can NOT
1. enhance your computer's capabilities
 2. fill some of the voids left by operating systems and applications software
 3. replace the need for application software to perform tasks like word processing and database
 4. make your computer more efficient
- 3-34. Software utilities can be categorized into which of the following groups?
1. File maintenance and file management only
 2. Keyboard enhancers, DOS shell, and backup utilities only
 3. Desktop organizers, printer utilities, and virus utilities only
 4. File management, file maintenance, keyboard enhancers, DOS shell, backup utilities, desktop organizers, printer utilities, and virus utilities
- 3-35. What type of utility usually includes a calculator, notepad, phone directory, and appointment book?
1. File management
 2. File maintenance
 3. Desktop organizer
 4. Printer

- 3-36. File compression routines are often a feature of backup utilities. They have which of the following advantages?
1. Make data easier to read
 2. Allow more data to be placed on a diskette
 3. Require fewer data files for data storage
 4. Each of the above
- 3-37. File management utilities perform which of the following functions?
1. Manipulate files only
 2. Manipulate directories only
 3. Manipulate files and directories
 4. Provide file recovery
- 3-38. File maintenance utilities are NOT designed to perform which of the following tasks?
1. Encrypt data
 2. Repair low-level format damage on hard disks
 3. Control access to resources and files
 4. Organize files and set file attributes
- 3-39. What person is the primary source in determining the input data and output material?
1. User
 2. Programmer
 3. I/O control clerk
 4. Technical administrator
- 3-40. How a file will be accessed by the program is determined at which of the following times?
1. When the DBMS is selected
 2. During the creation of the schema
 3. During the creation of the subschema
 4. When the file is downloaded
- 3-41. Which of the following is the most commonly used file organization method?
1. Sequential
 2. Indexed sequential
 3. Direct
- 3-42. Of the following features of a DBMS, which one, if any, is more important than the others?
1. Easy access to the data
 2. Storage and maintenance of large volumes of data
 3. Capability for sharing the data resources
 4. None; all are equally important
- 3-43. In a DBMS environment, users do not want to share their data with other users of the database.
1. True
 2. False
- 3-44. Technical and nontechnical DBMS users need different views of data.
1. True
 2. False

- 3-45. A conventional computer system has few application programs or systems using different databases and files.
1. True
 2. False
- 3-46. Which of the following defines a DBMS schema?
1. The actual data in the database framework
 2. The software description of the operating system
 3. An overall logical database description or framework
 4. A data aggregate of owner-type records
- 3-47. Which of the following items enhances security factors and helps prohibit data compromise?
1. A schema
 2. A subschema
 3. A subroutine
 4. A data converter
- 3-48. All data provided by the DBMS in response to a CALL for data is delivered to what is conceptually a loading and unloading zone called a
1. system buffer
 2. I/O control area
 3. user working area
 4. DBMS waiting buffer
- 3-49. A data item can be described as an occurrence of which of the following elements?
1. A bit in a database
 2. The largest unit of named data
 3. The smallest unit of named data
 4. A byte in a database
- 3-50. A data aggregate is an occurrence of a named collection of data items within a
1. byte
 2. file
 3. record
 4. system
- 3-51. A vector is which of the following (a) sequences of data items that have which of the following (b) characteristics?
1. (a) One-dimensional
(b) different
 2. (a) One-dimensional
(b) identical
 3. (a) Two-dimensional
(b) different
 4. (a) Two-dimensional
(b) identical
- 3-52. Which of the following is a unique value that identifies a record in the database to a run unit?
1. A sort key
 2. A search key
 3. An actual key
 4. A database key
- 3-53. An occurrence of a named collection of records is called a
1. key
 2. set
 3. mark
 4. keyword
- 3-54. Each set occurrence must contain what minimum number of occurrences if it is defined as an owner type of record?
1. One
 2. Two
 3. Three
 4. Four

- 3-55. A named collection of records that need not preserve owner/member relationships is called a/an
1. set
 2. area
 3. data item
 4. database key
- 3-56. A database consists of all of the following items controlled by a specific schema except which one?
1. Sets
 2. Areas
 3. Files
 4. Records
- 3-57. The data manipulation language relies on which of the following language types to provide the procedural capabilities required to manipulate data?
1. Host
 2. Query
 3. Application
 4. DDL
- 3-58. After the database physical description has been examined, which of the following items keys the actual physical record to be read?
1. DDL
 2. DBMS
 3. The object program
 4. The console operator
- 3-59. When data has been requested by a DBMS, to which of the following areas does the operating system deliver the requested data from the database?
1. User work area (UWA)
 2. System buffers
 3. DBMS
 4. DMS
- 3-60. After the operating system has transferred data to the system buffer area, where does the DBMS deliver the data to be used by a source program?
1. To a system work disk
 2. To a system work tape
 3. To the user work area (UWA)
 4. To system buffer areas 1 and 2
- 3-61. A schema data definition language (DDL) entry includes references to a physical device or media space.
1. True
 2. False
- 3-62. Which of the following items is/are contained in a DDL?
1. Literal formatting only
 2. Key words only
 3. Reserved words only
 4. Literal formatting, key words, and reserved words
- 3-63. To specify the relationship between DDL declarations and DML commands, a set of basic data manipulation functions must be defined that is independent of which of the following languages?
1. DML only
 2. Host language only
 3. DML and the host language
 4. DDL

3-64. When selecting a DBMS, the primary consideration should be to select a technology that will meet which of the following criteria?

1. Be the lowest cost
2. Be the easiest to use
3. Require the shortest implementation time
4. Support the long-term DBMS needs

3-65. When a DBMS is selected for a microcomputer system, which of the following is/are (an) important additional concern(s)?

1. Capability of receiving downloaded data
2. Ability to be used on a network
3. Ability to enable quick and easy screen formats
4. All of the above

STUDENT COMMENT SHEET

THIS FORM MAY BE USED TO SUGGEST IMPROVEMENTS, REPORT COURSE ERRORS, OR TO REQUEST HELP IF YOU HAVE DIFFICULTY COMPLETING THE COURSE.

NOTE: IF YOU HAVE NO COMMENTS, YOU DO NOT HAVE TO SUBMIT THIS FORM.

Date _____

FROM:

RATE/RANK/GRADE, NAME (FIRST, M.I., LAST)

STREET ADDRESS, APT #

CITY, STATE, ZIP CODE

DSN: _____

Commercial: _____

FAX: _____

INTERNET: _____

To: COMMANDING OFFICER
NETPDTC CODE N311
6490 SAUFLEY FIELD RD
PENSACOLA FL 32509-5237

Subj: RADIOMAN TRAINING SERIES, MODULE 2 - COMPUTER SYSTEMS, NAVEDTRA 12846

1. The following comments are hereby submitted:

PRIVACY ACT STATEMENT

UNDER AUTHORITY OF TITLE 5, USC 301, INFORMATION REGARDING YOUR MILITARY STATUS IS REQUESTED TO ASSIST IN PROCESSING YOUR COMMENTS AND IN PREPARING A REPLY. THIS INFORMATION WILL NOT BE DIVULGED WITHOUT WRITTEN AUTHORIZATION TO ANYONE OTHER THAN THOSE WITHIN DOD FOR OFFICIAL USE IN DETERMINING PERFORMANCE.

..... (Fold along dotted line)

..... (Fold along dotted line)

DEPARTMENT OF THE NAVY

COMMANDING OFFICER
NETPDTC CODE N311
6490 SAUFLEY FIELD RD
PENSACOLA FL 32509-5237

OFFICIAL BUSINESS

**COMMANDING OFFICER
NETPDTC CODE N311
6490 SAUFLEY FIELD RD
PENSACOLA FL 32509-5237**

PRINT OR TYPE

TITLE _____ NAVEDTRA _____

NAME _____ ADDRESS _____
Last First Middle Street/Ship/Unit/Division, etc.

City or FPO _____ State _____ Zip _____

RANK/RATE _____ SSN _____ DESIGNATOR _____ ASSIGNMENT NO. _____ DATE SUBMITTED _____

USN USNR ACTIVE INACTIVE OTHER (Specify) _____

SCORE

	1	2	3	4	
	T	F			
1	<input type="checkbox"/>	<input type="checkbox"/>	<input type="checkbox"/>	<input type="checkbox"/>	_____
2	<input type="checkbox"/>	<input type="checkbox"/>	<input type="checkbox"/>	<input type="checkbox"/>	_____
3	<input type="checkbox"/>	<input type="checkbox"/>	<input type="checkbox"/>	<input type="checkbox"/>	_____
4	<input type="checkbox"/>	<input type="checkbox"/>	<input type="checkbox"/>	<input type="checkbox"/>	_____
5	<input type="checkbox"/>	<input type="checkbox"/>	<input type="checkbox"/>	<input type="checkbox"/>	_____
6	<input type="checkbox"/>	<input type="checkbox"/>	<input type="checkbox"/>	<input type="checkbox"/>	_____
7	<input type="checkbox"/>	<input type="checkbox"/>	<input type="checkbox"/>	<input type="checkbox"/>	_____
8	<input type="checkbox"/>	<input type="checkbox"/>	<input type="checkbox"/>	<input type="checkbox"/>	_____
9	<input type="checkbox"/>	<input type="checkbox"/>	<input type="checkbox"/>	<input type="checkbox"/>	_____
10	<input type="checkbox"/>	<input type="checkbox"/>	<input type="checkbox"/>	<input type="checkbox"/>	_____
11	<input type="checkbox"/>	<input type="checkbox"/>	<input type="checkbox"/>	<input type="checkbox"/>	_____
12	<input type="checkbox"/>	<input type="checkbox"/>	<input type="checkbox"/>	<input type="checkbox"/>	_____
13	<input type="checkbox"/>	<input type="checkbox"/>	<input type="checkbox"/>	<input type="checkbox"/>	_____
14	<input type="checkbox"/>	<input type="checkbox"/>	<input type="checkbox"/>	<input type="checkbox"/>	_____
15	<input type="checkbox"/>	<input type="checkbox"/>	<input type="checkbox"/>	<input type="checkbox"/>	_____
16	<input type="checkbox"/>	<input type="checkbox"/>	<input type="checkbox"/>	<input type="checkbox"/>	_____
17	<input type="checkbox"/>	<input type="checkbox"/>	<input type="checkbox"/>	<input type="checkbox"/>	_____
18	<input type="checkbox"/>	<input type="checkbox"/>	<input type="checkbox"/>	<input type="checkbox"/>	_____
19	<input type="checkbox"/>	<input type="checkbox"/>	<input type="checkbox"/>	<input type="checkbox"/>	_____
20	<input type="checkbox"/>	<input type="checkbox"/>	<input type="checkbox"/>	<input type="checkbox"/>	_____
21	<input type="checkbox"/>	<input type="checkbox"/>	<input type="checkbox"/>	<input type="checkbox"/>	_____
22	<input type="checkbox"/>	<input type="checkbox"/>	<input type="checkbox"/>	<input type="checkbox"/>	_____
23	<input type="checkbox"/>	<input type="checkbox"/>	<input type="checkbox"/>	<input type="checkbox"/>	_____
24	<input type="checkbox"/>	<input type="checkbox"/>	<input type="checkbox"/>	<input type="checkbox"/>	_____
25	<input type="checkbox"/>	<input type="checkbox"/>	<input type="checkbox"/>	<input type="checkbox"/>	_____

	1	2	3	4	
	T	F			
26	<input type="checkbox"/>	<input type="checkbox"/>	<input type="checkbox"/>	<input type="checkbox"/>	_____
27	<input type="checkbox"/>	<input type="checkbox"/>	<input type="checkbox"/>	<input type="checkbox"/>	_____
28	<input type="checkbox"/>	<input type="checkbox"/>	<input type="checkbox"/>	<input type="checkbox"/>	_____
29	<input type="checkbox"/>	<input type="checkbox"/>	<input type="checkbox"/>	<input type="checkbox"/>	_____
30	<input type="checkbox"/>	<input type="checkbox"/>	<input type="checkbox"/>	<input type="checkbox"/>	_____
31	<input type="checkbox"/>	<input type="checkbox"/>	<input type="checkbox"/>	<input type="checkbox"/>	_____
32	<input type="checkbox"/>	<input type="checkbox"/>	<input type="checkbox"/>	<input type="checkbox"/>	_____
33	<input type="checkbox"/>	<input type="checkbox"/>	<input type="checkbox"/>	<input type="checkbox"/>	_____
34	<input type="checkbox"/>	<input type="checkbox"/>	<input type="checkbox"/>	<input type="checkbox"/>	_____
35	<input type="checkbox"/>	<input type="checkbox"/>	<input type="checkbox"/>	<input type="checkbox"/>	_____
36	<input type="checkbox"/>	<input type="checkbox"/>	<input type="checkbox"/>	<input type="checkbox"/>	_____
37	<input type="checkbox"/>	<input type="checkbox"/>	<input type="checkbox"/>	<input type="checkbox"/>	_____
38	<input type="checkbox"/>	<input type="checkbox"/>	<input type="checkbox"/>	<input type="checkbox"/>	_____
39	<input type="checkbox"/>	<input type="checkbox"/>	<input type="checkbox"/>	<input type="checkbox"/>	_____
40	<input type="checkbox"/>	<input type="checkbox"/>	<input type="checkbox"/>	<input type="checkbox"/>	_____
41	<input type="checkbox"/>	<input type="checkbox"/>	<input type="checkbox"/>	<input type="checkbox"/>	_____
42	<input type="checkbox"/>	<input type="checkbox"/>	<input type="checkbox"/>	<input type="checkbox"/>	_____
43	<input type="checkbox"/>	<input type="checkbox"/>	<input type="checkbox"/>	<input type="checkbox"/>	_____
44	<input type="checkbox"/>	<input type="checkbox"/>	<input type="checkbox"/>	<input type="checkbox"/>	_____
45	<input type="checkbox"/>	<input type="checkbox"/>	<input type="checkbox"/>	<input type="checkbox"/>	_____
46	<input type="checkbox"/>	<input type="checkbox"/>	<input type="checkbox"/>	<input type="checkbox"/>	_____
47	<input type="checkbox"/>	<input type="checkbox"/>	<input type="checkbox"/>	<input type="checkbox"/>	_____
48	<input type="checkbox"/>	<input type="checkbox"/>	<input type="checkbox"/>	<input type="checkbox"/>	_____
49	<input type="checkbox"/>	<input type="checkbox"/>	<input type="checkbox"/>	<input type="checkbox"/>	_____
50	<input type="checkbox"/>	<input type="checkbox"/>	<input type="checkbox"/>	<input type="checkbox"/>	_____

	1	2	3	4	
	T	F			
51	<input type="checkbox"/>	<input type="checkbox"/>	<input type="checkbox"/>	<input type="checkbox"/>	_____
52	<input type="checkbox"/>	<input type="checkbox"/>	<input type="checkbox"/>	<input type="checkbox"/>	_____
53	<input type="checkbox"/>	<input type="checkbox"/>	<input type="checkbox"/>	<input type="checkbox"/>	_____
54	<input type="checkbox"/>	<input type="checkbox"/>	<input type="checkbox"/>	<input type="checkbox"/>	_____
55	<input type="checkbox"/>	<input type="checkbox"/>	<input type="checkbox"/>	<input type="checkbox"/>	_____
56	<input type="checkbox"/>	<input type="checkbox"/>	<input type="checkbox"/>	<input type="checkbox"/>	_____
57	<input type="checkbox"/>	<input type="checkbox"/>	<input type="checkbox"/>	<input type="checkbox"/>	_____
58	<input type="checkbox"/>	<input type="checkbox"/>	<input type="checkbox"/>	<input type="checkbox"/>	_____
59	<input type="checkbox"/>	<input type="checkbox"/>	<input type="checkbox"/>	<input type="checkbox"/>	_____
60	<input type="checkbox"/>	<input type="checkbox"/>	<input type="checkbox"/>	<input type="checkbox"/>	_____
61	<input type="checkbox"/>	<input type="checkbox"/>	<input type="checkbox"/>	<input type="checkbox"/>	_____
62	<input type="checkbox"/>	<input type="checkbox"/>	<input type="checkbox"/>	<input type="checkbox"/>	_____
63	<input type="checkbox"/>	<input type="checkbox"/>	<input type="checkbox"/>	<input type="checkbox"/>	_____
64	<input type="checkbox"/>	<input type="checkbox"/>	<input type="checkbox"/>	<input type="checkbox"/>	_____
65	<input type="checkbox"/>	<input type="checkbox"/>	<input type="checkbox"/>	<input type="checkbox"/>	_____
66	<input type="checkbox"/>	<input type="checkbox"/>	<input type="checkbox"/>	<input type="checkbox"/>	_____
67	<input type="checkbox"/>	<input type="checkbox"/>	<input type="checkbox"/>	<input type="checkbox"/>	_____
68	<input type="checkbox"/>	<input type="checkbox"/>	<input type="checkbox"/>	<input type="checkbox"/>	_____
69	<input type="checkbox"/>	<input type="checkbox"/>	<input type="checkbox"/>	<input type="checkbox"/>	_____
70	<input type="checkbox"/>	<input type="checkbox"/>	<input type="checkbox"/>	<input type="checkbox"/>	_____
71	<input type="checkbox"/>	<input type="checkbox"/>	<input type="checkbox"/>	<input type="checkbox"/>	_____
72	<input type="checkbox"/>	<input type="checkbox"/>	<input type="checkbox"/>	<input type="checkbox"/>	_____
73	<input type="checkbox"/>	<input type="checkbox"/>	<input type="checkbox"/>	<input type="checkbox"/>	_____
74	<input type="checkbox"/>	<input type="checkbox"/>	<input type="checkbox"/>	<input type="checkbox"/>	_____
75	<input type="checkbox"/>	<input type="checkbox"/>	<input type="checkbox"/>	<input type="checkbox"/>	_____

