

## CHAPTER 6

## EVALUATION TECHNIQUES AND MEASUREMENTS

## 6.1 COMPATIBILITY EVALUATION TECHNIQUES

The Department of Defense, in its Directive 3222.3, has established a formal Electromagnetic Compatibility Program which includes the collection and establishment for a library of spectrum signatures among its provisions. A library of such spectrum signatures is maintained at the ECAC. OPNAVINST 2410.17 outlines naval responsibility for the collection and submission of spectrum signatures. MIL-STD-449 establishes the uniform measuring techniques to be used for such collections. Pertinent details regarding ECAC and the services provided are identified in paragraph 1.5.

6.1.1 General Considerations

In the planning and installation of C-E equipment at a new site, or in the addition of equipments to an existing site, the achievement of system compatibility is a required goal. The implementation of a formal EMC program to attain that goal will generally seek the answers to such questions as:

- o What are the effects of adding new sources of potential interference to an existing site?
- o What are the effects of changing operating schedules or operating frequencies of equipment within a site?
- o What are the potential interference problems within the site?
- o What are the causes of observed interference?
- o What solutions to interference problems are possible, and what is their effectiveness?

The answers to these and other related questions may be found through the establishment of an interference analysis or prediction process within the overall compatibility program.

The fundamental concept of the prediction process is to determine whether one or more sources within an electromagnetic environment generate emissions capable of producing interference at each susceptible equipment. To accomplish this, one must:

- o Identify the equipment and subsystem classes based on intended installation.
- o Identify ancillary or auxiliary equipment and subsystems which support and are used in the intended installation.
- o Identify ancillary or support equipment or subsystems which are not physically located in critical areas in the intended installation.
- o Identify equipment or subsystems used for general military needs which are not associated with a specific system.
- o Identify facilities equipment and subsystems installed in buildings or at sites.
- o Define or characterize the signals produced by the source(s).

- o Determine the effects on the signals during transmission from the source to the susceptible or victim equipment.
- o Define or characterize the susceptibility properties of the "victim" equipment.
- o Determine whether the signals present at the susceptible equipment create interference.
- o Request ECAC services in accordance with procedures stated in paragraph 1.5.

A prediction model is required to determine whether the signals present at the susceptible equipment create interference, i.e., a set of concepts, defined by mathematical formulas or procedures, by means of which the prediction is made. Many types of such interference prediction models may be found in the literature, each oriented toward different aspects of prediction, e.g., models for predicting antenna to antenna interference, cable coupling interference, case radiation interference, etc. Once the model has been selected, it may be implemented either by the use of manual calculations, charts, nomograms, etc., or by the use of computer techniques, depending on the nature and complexity of the model.

The characterizations of the source, transmission effects, and victim susceptibility must be determined. These characterizations serve as the input functions to the prediction model. In general, the characterization, or modeling, of these effects is a formidable task. The characteristics of transmitters, receivers and antennas, for example, must be modeled for a large number of equipments. Transmission effects must include the modeling of the many modes of radio propagation or other coupling phenomena, as applicable, and include such factors as site effects, obstructions, overhead powerlines, mobile equipment, etc. To confine the problem within reasonable bounds, certain simplifying assumptions are usually made during the equipment modeling process. These are outlined in following sections.

The basic input functions to the prediction process are generally represented by amplitude levels of either power, voltage or current as a function of time or frequency. In either representation, the input model must reflect the random nature of many of these functions with respect to such equipment parameters as equipment class or type number, tuned frequency, load impedances, etc. Thus, each of the input functions is obtained statistically through a combination of measurement and calculation, and is defined in terms of probability distributions which are either time independent or time dependent.

The indication of interference obtained by insertion of the input functions into the prediction model should be related to system or equipment performance requirements in order to achieve a more meaningful measure of compatibility. This requires the defining of objective degradation criteria.

A detailed model and prediction technique which demonstrates some of the concepts discussed above may be found in RADC-TR-66-1, Interference Notebook.

In those cases where the required statistical data is not available or cannot be adequately measured, an alternate prediction model is outlined in this chapter. The intent is to provide field engineering and installation personnel with a feasible and practical prediction model. Although the following is specifically detailed and outlined for EMI predictions, aspects of the techniques are applicable to RADHAZ predictions also.

## 6.2 BASIC PREDICTION TECHNIQUE

The basic prediction technique outlined herein makes use of the ON-AXIS, FREE SPACE, FAR FIELD transmission equation expanded to accommodate such additional factors as receiver noise level, losses due to obscured propagation, polarization misalignment, off-axis antenna orientation, interference level scoring criteria, and transmitter spurious modulation or sideband energy existing at frequencies lying in the passband of a receiver. An interference-to-noise ratio (I/N) is calculated, and then related to the operational receiver signal-to-noise ratio (S/N) to obtain a time-variant signal-to-interference ratio (S/I) at the receiver output. This S/I ratio is interpreted through the use of scoring tables which reflect the susceptibility of different types of reception to varying degrees of EMI.

The following one-way transmission equation applies for optimum conditions as stated,

$$P_D = \frac{P_t G_t}{4\pi R^2} \text{ watts/m}^2 \quad (6-1)$$

where:

$P_D$  = power density (watts/m<sup>2</sup>)

$P_t$  = transmitted power (watts)

$G_t$  = rated on-axis transmitter antenna gain

$R$  = distance between transmitter and receiver (meters)

Since equation 6-1 represents power density and is based on optimum conditions only, some of the characteristics of the receiving equipment and other modifying factors are now introduced:

$$I/N = \frac{P_{tr} G_t A_r B_r}{4\pi R^2 L_p H L_t L_r N} \quad (6-2)$$

where:

$I$  = the potential interfering power (in watts) existing at the receiver input terminals.

$P_{tr}$  = transmitter output power existing within the 3dB bandwidth of the potentially interfered receiver (in watts/megahertz).

$G_t$  = rated on-axis transmitter antenna gain (numeric).

$A_r$  = effective aperture of the receiver antenna (in meters squared).

$L_p$  = loss factor to account for possible polarization differences between the receiving antenna and the arriving wave (numeric).

$H$  = propagation correction factor for other than free space or line-of-sight conditions (numeric).

$L_t$  = transmitter antenna output transmission line loss (numeric).

$L_r$  = receiver antenna input transmission line loss (numeric).

$N$  = receiver internal noise power within its 3 dB bandwidth referred to the input terminals (in watts).

$B_r$  = receiver bandwidth at 3 dB points (in megahertz).

Equation 6-2 provides the relationship of the transmitted interference power as referenced to the noise level of the receivers. The values computed using this equation are dimensionless. However, for ease of computation, it is desirable to have the values of each of the parameters in the right-hand side of the equation be in commonly used terms. For example, in normal practice the values of distance are usually given in statute miles, and the gain of the receiving antennas are generally given in terms of a ratio (dB above an isotropic radiator) rather than by

effective aperture. Therefore, equation 6-2 is further modified to permit the use of the more common values of the equation parameters. To do this, however, a constant of proportionality must be developed, so that the computed I/N values will remain a dimensionless ratio. Performing the indicated changes, therefore, equation 6-3 results:

$$I/N = \frac{K P_{tr} G_t G_r B_r}{R L_p H L_t L_r f_r^2 N} \tag{6-3}$$

where:

- P<sub>tr</sub> is in watts/MHz
- G<sub>t</sub>G<sub>r</sub> is antenna gain power ratios
- B<sub>r</sub> is in MHz
- R is in statute miles
- L<sub>p</sub>L<sub>t</sub>L<sub>r</sub> are power ratios
- f<sub>r</sub> is in MHz
- N is in mW
- K is a constant of proportionality

Since the signal-to-interference ratio (S/I) is a more direct measure of a given receiver-transmitter interference situation, it is generally used for predicting interference. To obtain the S/I for a given situation, the I/N ratio from Equation 6-3 is related to the receiver operational (not threshold) signal-to-noise ratio. This is done as follows:

$$(S/N)_{dB} - (IN)_{dB} = (S/I)_{dB} \tag{6-4}$$

Equations 6-3 and 6-4 represent the basic prediction technique which is portrayed on the EMI Prediction Calculation sheet (figure 6-1). Using these equations, a measure of potential interference between a given transmitter-receiver pair can be calculated. It is desirable to use measured data for each of the parameters in these equations which are represented on the EMI Prediction Calculation sheet. These measured data not only include the discrete equipment characteristics such as antenna gain, receiver sensitivity, etc., but also transmitter Effective Radiated Power (ERP) and power densities existing at a proposed or installed receiver location. To enable field personnel to efficiently use these measured data, Equation 6-3 is divided into the basic elements of an interference situation; transmitter, propagation, and receiver.

Once the basic EMI prediction and analysis tools are derived, it is necessary to define the overall prediction method in further detail. Thus, other supporting forms have been developed to document both the nominal and operational characteristics of the C-E equipments; document relative location plan and profile maps of the transmitter/receiver pairs; and record reasons for the elimination of certain transmitter/receiver pairs from a detailed EMI calculation.

### 6.3 C-E EQUIPMENT DATA DOCUMENTATION

The basic equipment data required to perform an interference analysis of a particular site complex include two basic types: (1) C-E equipment characteristics, and (2) environmental data. These classifications are presently used by the Department of Defense Compatibility Program. In the DOD Program, the C-E equipment characteristics have been termed spectrum signatures (MIL-STD-449).



1			TX _____
2			RX _____
3			CODE _____
4			DATE OF FORM _____

**EMI PREDICTION CALCULATION**

5	Transmitter (TX) _____	Receiver (RX) _____
6	TX Site _____	RX Site _____ Separation _____ mi
7	TX Frequency ( $f_t$ ) _____ MHz	RX Frequency ( $f_r$ ) _____ MHz
8	Frequency of Interference ( $f_i$ ) _____ MHz	( $f_i$ ) is _____ function of ( $f_t$ )
9	TX Antenna Polarization _____	RX Antenna Polarization _____

NO. ENTRIES		COLUMN
		A    B    C    D
		+dB -dB +dB -dB

<b>1. TRANSMITTER</b>		
1.1 TX Power (Fill in radar TX or communications TX section)		
10	1.1.1 Fundamental Cochannel Interference ( $f_r = f_t$ )	
	1.1.1.1 $[10 \log P_t] + 30$	<input type="checkbox"/> <input checked="" type="checkbox"/>
11	1.1.2 Fundamental Adjacent-Channel Interference	
12	1.1.2.1 $[10 \log P_t] + 30$	<input type="checkbox"/> <input checked="" type="checkbox"/>
	1.1.2.2 $-40 \log (\pi \tau \Delta f_{\text{MHz}})$ see fig. 6-13	<input checked="" type="checkbox"/> <input type="checkbox"/>
13	1.1.2.3 $-20 \log K$	<input type="checkbox"/> <input checked="" type="checkbox"/>
14	1.1.3 Harmonic Cochannel Interference ( $f_r = nf_t$ )	
15	1.1.3.1 $[10 \log P_t] + 30$	<input type="checkbox"/> <input checked="" type="checkbox"/>
	-dB down from $f_o$ refer to table 6-5	<input checked="" type="checkbox"/> <input type="checkbox"/>
16	1.1.4 Harmonic Adjacent-Channel Interference	
17	1.1.4.1 $[10 \log P_t] + 30$	<input type="checkbox"/> <input checked="" type="checkbox"/>
18	1.1.4.2 -dB down from $f_o$	<input checked="" type="checkbox"/> <input type="checkbox"/>
19	1.1.4.3 $-40 \log (\pi \tau \Delta f_{\text{MHz}})$	<input type="checkbox"/> <input checked="" type="checkbox"/>
20	1.1.4.4 $-20 \log K$	<input type="checkbox"/> <input checked="" type="checkbox"/>
21	1.1.5 Fundamental Cochannel Interference ( $f_r = f_t$ )	
	1.1.5.1 $[10 \log P_t] + 30$	<input type="checkbox"/> <input checked="" type="checkbox"/>
22	1.1.6 Harmonic Cochannel Interference ( $f_r = nf_t$ )	
	1.1.6.1 $[10 \log P_t] + 30$	<input type="checkbox"/> <input checked="" type="checkbox"/>
	-dB down from $f_o$	<input checked="" type="checkbox"/> <input type="checkbox"/>
23	1.2 TX Transmission Line Loss: $L_t(\text{dB})$ see fig. 6-14, 6-15	<input checked="" type="checkbox"/> <input type="checkbox"/>
24	1.3 TX Antenna Gain: $G_r(\text{dB})$	<input type="checkbox"/> <input checked="" type="checkbox"/>
25	1.3.1 Loss due to off axis pointing at RX	<input checked="" type="checkbox"/> <input type="checkbox"/>
26	1.3.2 Loss due to near field effect	<input checked="" type="checkbox"/> <input type="checkbox"/>
27	1.4 Subtotal Line 1.1.1 through Line 1.3.2 Column A	<input type="checkbox"/> <input checked="" type="checkbox"/>

Radar TX  
 Comm TX

AIAF 233

Figure 6-1. EMI Prediction Calculation Sheet (1 of 3)

28	1.5 Subtotal, Line 1.1.1 through Line 1.3.2, Column B	<input type="checkbox"/>	<input type="checkbox"/>	<input type="checkbox"/>	<input type="checkbox"/>
29	1.6 Total [Line 1.4] - [Line 1.5] - Effective Radiated Power (dBm)	<input type="checkbox"/>	<input type="checkbox"/>	<input type="checkbox"/>	<input type="checkbox"/>
<b>2. PROPAGATION</b>					
	2.1 Constant	<input type="checkbox"/>	<input type="checkbox"/>	<input type="checkbox"/>	<input type="checkbox"/>
30	2.2 Wave Spreading, TX-RX Distance: $-20 \log R_{mi}$ (see fig 6-25)	<input type="checkbox"/>	75.1	<input type="checkbox"/>	<input type="checkbox"/>
31	2.3 Reflection Field (see fig 6-26)	<input type="checkbox"/>	<input type="checkbox"/>	<input type="checkbox"/>	<input type="checkbox"/>
32	2.4 Diffraction Field	<input type="checkbox"/>	<input type="checkbox"/>	<input type="checkbox"/>	<input type="checkbox"/>
33	2.5 Scatter Field	<input type="checkbox"/>	<input type="checkbox"/>	<input type="checkbox"/>	<input type="checkbox"/>
34	2.6 Subtotal: Line 2.1 through 2.5, Column A	<input type="checkbox"/>	<input type="checkbox"/>	<input type="checkbox"/>	<input type="checkbox"/>
35	2.7 Subtotal: Line 2.1 through 2.5, Column B	<input type="checkbox"/>	<input type="checkbox"/>	<input type="checkbox"/>	<input type="checkbox"/>
36	2.8 Total: [Line 2.6] - [Line 2.7]	<input type="checkbox"/>	<input type="checkbox"/>	<input type="checkbox"/>	<input type="checkbox"/>
37	2.9 Power Density Existing at RX in $\text{dBm/m}^2/\text{MHz}$ Line 1.6 + 2.8	<input type="checkbox"/>	<input type="checkbox"/>	<input type="checkbox"/>	<input type="checkbox"/>
<b>3. RECEIVER</b>					
38	3.1 Loss due to Polarization Mismatch (Refer to table 6-9) Fill in 3.2 if known; if not, fill in 3.2.1 through 3.2.3.2	<input type="checkbox"/>	<input type="checkbox"/>	<input type="checkbox"/>	<input type="checkbox"/>
39	3.2 RX Effective Area: $10 \log A_r$	<input type="checkbox"/>	<input type="checkbox"/>	<input type="checkbox"/>	<input type="checkbox"/>
	3.2.1 Constant	<input type="checkbox"/>	38.6	<input type="checkbox"/>	<input type="checkbox"/>
40	3.2.2 RX Frequency; $-20 \log f_{\text{MHz}}$ (see fig 6-34)	<input type="checkbox"/>	<input type="checkbox"/>	<input type="checkbox"/>	<input type="checkbox"/>
41	3.2.3 RX Antenna Gain: $G_r$ (dB)	<input type="checkbox"/>	<input type="checkbox"/>	<input type="checkbox"/>	<input type="checkbox"/>
42	3.2.3.1 Loss due to off axis pointing at TX:	<input type="checkbox"/>	<input type="checkbox"/>	<input type="checkbox"/>	<input type="checkbox"/>
43	3.2.3.2 Loss due to near field effect	<input type="checkbox"/>	<input type="checkbox"/>	<input type="checkbox"/>	<input type="checkbox"/>
44	3.3 RX Transmission Line Loss: $L_R$ (dB) (see figs. 6-14, 6-15)	<input type="checkbox"/>	<input type="checkbox"/>	<input type="checkbox"/>	<input type="checkbox"/>
45	3.4 Subtotal: Line 3.1 through 3.3, column A	<input type="checkbox"/>	<input type="checkbox"/>	<input type="checkbox"/>	<input type="checkbox"/>
46	3.5 Subtotal: Line 3.1 through 3.3, column B	<input type="checkbox"/>	<input type="checkbox"/>	<input type="checkbox"/>	<input type="checkbox"/>
47	3.6 Total: [Line 3.4] - [Line 3.5]	<input type="checkbox"/>	<input type="checkbox"/>	<input type="checkbox"/>	<input type="checkbox"/>
48	3.7 Received Interference Power: Line 2.9 + (Line 3.6) dBm	<input type="checkbox"/>	<input type="checkbox"/>	<input type="checkbox"/>	<input type="checkbox"/>
49	3.8 RX Bandwidth (BW) (Fill in only if one of the following situations exists)	<input type="checkbox"/>	<input type="checkbox"/>	<input type="checkbox"/>	<input type="checkbox"/>
	3.8.1 Fundamental Cochannel Interference Where $BW_{RX} < \frac{2}{T}$	<input type="checkbox"/>	<input type="checkbox"/>	<input type="checkbox"/>	<input type="checkbox"/>
	3.8.1.1 $10 \log (0.5 \tau BW_{RX})$ MHz	<input type="checkbox"/>	<input type="checkbox"/>	<input type="checkbox"/>	<input type="checkbox"/>
50	3.8.2 Fundamental Adjacent Channel Interference	<input type="checkbox"/>	<input type="checkbox"/>	<input type="checkbox"/>	<input type="checkbox"/>
	3.8.2.1 $10 \log (BW_{RX})$ MHz	<input type="checkbox"/>	<input type="checkbox"/>	<input type="checkbox"/>	<input type="checkbox"/>
51	3.8.3 Harmonic Cochannel Interference Where $BW_{RX} < \frac{2}{T}$	<input type="checkbox"/>	<input type="checkbox"/>	<input type="checkbox"/>	<input type="checkbox"/>
	3.8.3.1 $10 \log (0.5 \tau BW_{RX})$	<input type="checkbox"/>	<input type="checkbox"/>	<input type="checkbox"/>	<input type="checkbox"/>
52	3.8.4 Harmonic Adjacent Channel Interference	<input type="checkbox"/>	<input type="checkbox"/>	<input type="checkbox"/>	<input type="checkbox"/>
	3.8.4.1 $10 \log (BW_{RX})$ MHz	<input type="checkbox"/>	<input type="checkbox"/>	<input type="checkbox"/>	<input type="checkbox"/>
53	3.8.5 $10 \log (BW_{RX})$ MHz	<input type="checkbox"/>	<input type="checkbox"/>	<input type="checkbox"/>	<input type="checkbox"/>
54	3.8.6 $-10 \log (BW_{TX})$ MHz	<input type="checkbox"/>	<input type="checkbox"/>	<input type="checkbox"/>	<input type="checkbox"/>
55	3.9 RX Sensitivity in Units of -dBm: N dBm	<input type="checkbox"/>	<input type="checkbox"/>	<input type="checkbox"/>	<input type="checkbox"/>
56	3.10 Subtotal: Lines 3.8 through 3.9, column A	<input type="checkbox"/>	<input type="checkbox"/>	<input type="checkbox"/>	<input type="checkbox"/>

AIAF 233

Figure 6 - 1. EMI Prediction Calculation Sheet ( 2 of 3 )

57	3.11 Subtotal: Lines 3.8 through 3.9, column B	
58	3.12 Total: [Line 3.10] - [Line 3.11] = Adjusted RX Threshold	
<b>4. PREDICTED INTERFERENCE LEVEL</b>		
59	4.1 I/N Ratio, Total of Line 3.7 + Line 3.12	
60	4.2 Assumed or Known RX (S/N) dB Ratio	
	4.3 Predicted S/I Ratio	
61	4.3.1 For $I/N > 0$ dB; $(S/I)_{dB} = (S/N)_{dB} - (I/N)_{dB}$ : Line 4.2 - Line 4.1	
	4.3.2 For $I/N \leq 0$ dB; $(S/I)_{dB} = (S/N)_{dB}$ No Interference Exists	

AIAF 233

Figure 6 - 1. EMI Prediction Calculation Sheet ( 3 of 3 )

Environmental data also can be termed local operations characteristics. To differentiate between the concept of environmental data and spectrum signature, refer to figure 6-2. The environmental or local operations data refer to those characteristics, such as antenna height or orientation, which may be unique to a particular physical equipment site, but are not unique to a particular class or type of equipment which may operate in various site complexes. In addition to the basic equipment and environmental data, it is necessary to know the signal complex under study. A C-E equipment census is made which yields the total number and deployment of C-E equipments in the complex.

6.3.1 C-E Equipment Characteristics

The nominal equipment characteristics required for interference prediction have been formulated for radar and communications equipment. These characteristics are shown on separate data sheets for Radar (figure 6-3) and Communications Equipments (figures 6-4 to 6-6). Three separate forms are shown for the communications equipments since, often, different antenna systems are used. In the case of a system such as the AN/GRC-27 which includes transmitter, receiver and antennas, the forms can be combined.

The characteristics listed on the forms (figures 6-3, 6-4, 6-5, and 6-6) are all that are required to perform the manual prediction. However additional detailed characteristics may be used in performing a comprehensive interference prediction and analysis of a given situation. For example, in a first order prediction, carrier stability is not an important or necessary consideration. However, when considering the time variant or long term duration of an interference situation, this must be taken into consideration. A prediction may be made where the ultimate or final recommendation is to use frequency reassignment. In other words, operate transmitter "A" at 2700 MHz and operate receiver "B" at 2725 MHz. If transmitter "A" were the AN/FPS-6, this recommendation would soon be negated by the appearance of interference in a relatively short time. In this particular case, the AN/FPS-6 is known to drift considerably over specified periods of time.

Information to assist in completing the principal characteristics data sheets is provided in Table 6-1 for radar equipment and in Table 6-2 for communications equipments.

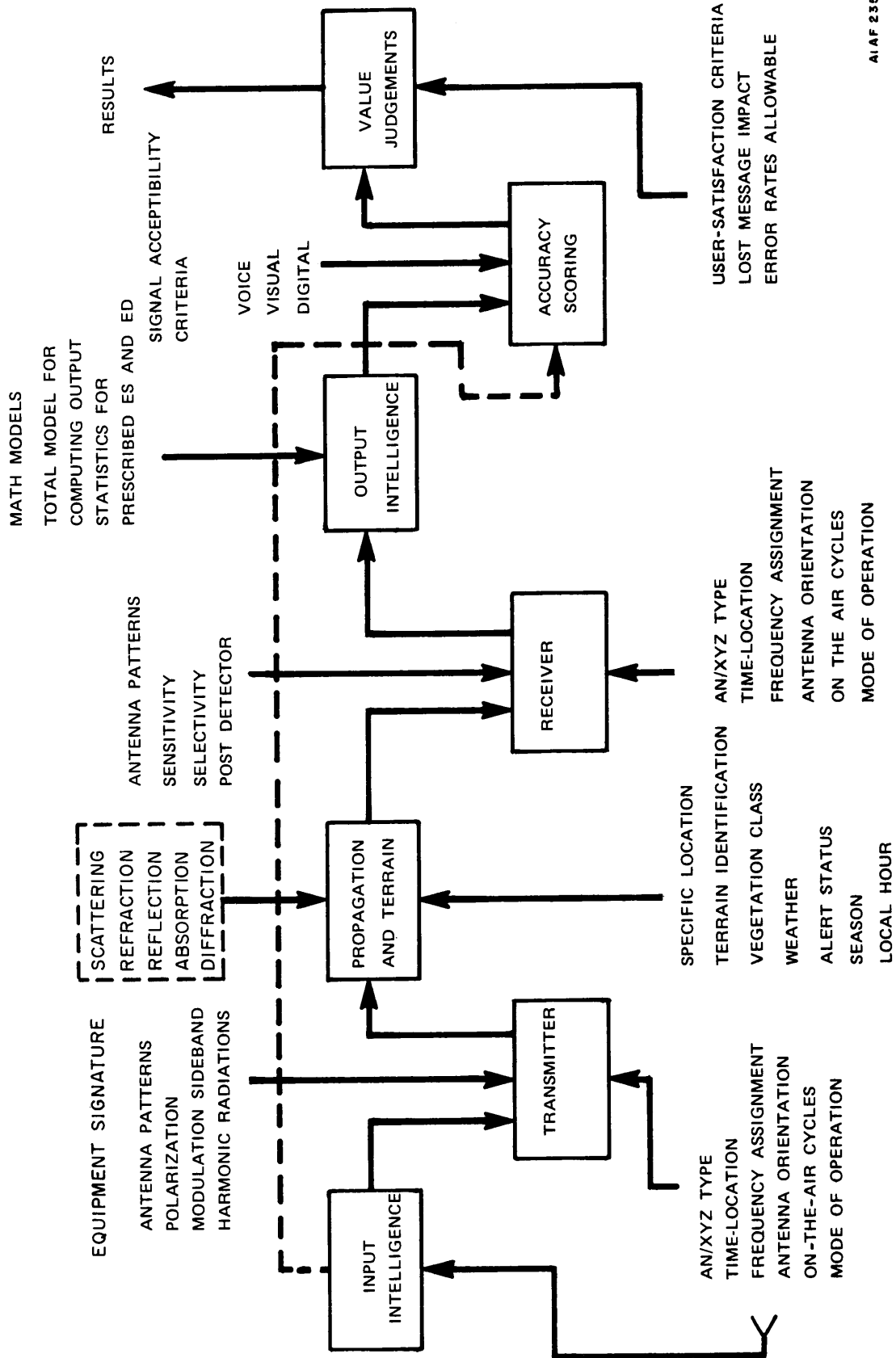

AIAF 235

Figure 6 - 2. Factors Involved in a Single Transmitter / Receiver Interference Prediction

RADAR _____	
<b>Transmitter</b>	
Frequency Range _____ MHz to _____ MHz ; Peak Power _____ kW	
Pulse Width _____ $\mu$ sec PRR _____ pps Pulse-shape factor _____	
<b>Receiver</b>	
Sensitivity _____ -dBm; Bandwidth(3dB) _____ MHz	
Operational S/N _____ dB	
Antenna _____ Type (describe) _____	
Gain _____ dB	Scan Rate _____ r/min
Polarization _____	
Horizontal Beamwidth _____	Vertical Beamwidth _____
Remarks _____	
AIAF 239	

Figure 6 - 3. Radar Principal Equipment Characteristics Form

RECEIVERS	
Receiver _____	
Frequency Range _____ MHz to _____ MHz ; Sensitivity _____ dBm	
Bandwidth (3dB) _____ kHz ; Operational (S/N) _____ dB	
Type Emission Received _____	
Remarks _____	
AIAF 238	

Figure 6 - 4. Communications Principal Equipment Characteristics Form - Receivers

ANTENNAS	
Antenna _____	Type (describe) _____
Frequency Range _____ MHz to _____ MHz;	Gain _____ dB
Polarization _____	
Horizontal Pattern _____	Vertical Pattern _____
Remarks _____ _____	
AIAF 237	

Figure 6 - 5. Communications Principal Equipment Characteristics Form - Antennas

TRANSMITTERS	
Transmitter _____	
Frequency Range _____ MHz to _____ MHz;	Bandwidth _____ kHz
Carrier Power, PEP _____ kW;	
Emission Type _____	
Remarks _____ _____	
AIAF 236	

Figure 6 - 6. Communications Principal Equipment Characteristics Form - Transmitters

Table 6-1. Delineation of Radar Principal Characteristics Form

ENTRY	DESCRIPTOR	EXAMPLE
<b>Principal Characteristics</b>		
<u>Transmitter</u>		
Frequency range	Operating frequency range MHz	9000-10,000 MHz
Peak power	Peak power output in kW	10 <sup>4</sup> kW
Pulse width	Duration of a single pulse	6 μsec
PRR	No. of times/second one pulse is repeated	300 pps
Pulse shape factor	Ratio of rise time + fall time to pulse width	0.10
<u>Receiver</u>		
Sensitivity	Threshold noise power level (FKTB) in dBm	-110 dBm
Bandwidth (3dB)	3 dB bandwidth	6 kHz
Operational S/N	RCVR S/N in dB (power)	10 dB
<u>Antenna</u>		
Gain	Power gain relative to isotropic antenna in dB	40 dB
Horizontal beamwidth	Horizontal 3 dB beamwidth in degrees	3°
Vertical beamwidth	Vertical 3 dB beamwidth in degrees	20°
Scan rate	Revolutions per minute	6 r/min
Polarization	Horizontal, vertical, circular	Circular

Table 6-2. Delineation of Communications Principal Equipment Characteristics Form

ENTRY	DESCRIPTOR	EXAMPLE
<b>Principal Characteristics</b>		
<u>Receiver</u>		
Frequency range	Operating frequency range in MHz	220 to 480 MHz
Sensitivity	Threshold noise power level (FKTB) in dBm	90dBm
Bandwidth	3dB bandwidth in kHz	5 kHz
(S/N) operational	RX output S/N in dB (power)	10dB
Type emission rec.	Standard emission symbols	A 3
<u>Antenna</u>		
Gain	Power gain relative to isotropic antenna in dB	6dB
Frequency range	Operating frequency range in MHz	220 to 480 MHz
Polarization	Horizontal, vertical, circular	Vertical
Horizontal beamwidth	Horizontal 3 dB beam width in degrees	3°
Vertical beamwidth	Vertical 3 dB beam width in degrees	20°
<u>Transmitter</u>		
Frequency range	Operating frequency range in MHz	220 to 480 MHz
Carrier power	Power in kW	0.1
Emission type	Standard emission symbols	A3
Bandwidth	Emission 3 dB bandwidth in kHz	6 kHz

### 6.3.2 C-E Equipment Local Operation (Environmental Data)

Environmental data consists of those characteristics which uniquely identify a transmitter or receiver in a complex such as an air station. These characteristics include location, terrain considerations, operational duty cycles, etc. The Environmental Characteristics Form is shown in figure 6-7. The upper right hand corner of the form includes information to enable quick storage and retrieval of the particular completed environmental form. Refer to Table 6-3 for details relative to the entries on the form.

The layout of a Naval Shore Station is such that there are several equipments of the same type at a site. For example, at a VHF/UHF transmitter site, there might be six AN/URT-7 transmitters and five TV-6 transmitters. One copy of the form is required for the AN/URT-7 at the site and one copy for the TV-6 at the site. If an AN/URT-7 is also installed at another site, such as in the control tower, a second copy of the form should be completed to provide the environmental characteristics of the equipment at that site.

### 6.3.3 C-E Equipment Census

The simplest method for preparing a complete presentation of the environment or census is to complete the C-E Equipment Data Sheets, the Environmental Data Sheets, and then plot the location of each equipment on a contour map of the area. A contour map (contour intervals of 25 to 100 feet) is recommended because of the effects of terrain on the propagation of electromagnetic radiated signals. However, if the terrain is relatively smooth, as is the case with most stations, this type map is not necessary, however it is important that the relative location of the equipments be plotted. At most Naval Shore Stations, frequencies are assigned to functions, therefore, it is also desirable to have a list of the frequencies assigned to the station and their use.

## 6.4 PRELIMINARY SORTING

Analysis of a complex for EMI consists in viewing each receiver in turn to determine to what extent its optimum performance will be reduced by the environment. In those cases where the performance is reduced, it is necessary to identify the transmitters causing the degradation.

In a complex such as a shore station the large number of receivers requires that some sequence of examination of possible interference be developed. This order may be based on the priority of the circuit involved or on the basis of circuits which presently experience interference that should be reduced or eliminated.

Once this sequence has been established, the next step is to readily identify those transmitters on the station which will not interfere with the receiver under consideration, so that they may be eliminated from the detailed analysis.

This rapid identification or rapid culling of non-interfering transmitters is actually a very coarse form of the basic prediction technique incorporating transmitter-receiver frequency separation, effective radiated power, and the effects of terrain masking.

The rapid cull technique presented in the following paragraphs is a go/no-go method based, for the most part, on extremely pessimistic (i.e., interference prone) conditions. A basic form which can be used for recording the C-E equipment information with regard to each receiver is shown in figure 6-8.

### 6.4.1 Frequency Sorting

The simplest method for quickly eliminating transmitters which will not interfere with the receiver under study is to compare the receiver frequency with the frequencies being radiated by each transmitter within the complex. When certain relationships exist between the receiver frequency and the frequencies of a transmitter, the latter can be eliminated as a possible source of interference to the receiver. It is possible that signals in combination with other signals may cause interference but this type of interference (e.g., intermodulation) is beyond the scope of this manual technique.



Site \_\_\_\_\_  
 Equipment Nomen. \_\_\_\_\_  
 Code \_\_\_\_\_ Revision \_\_\_\_\_  
 Date of Form \_\_\_\_\_

ENVIRONMENTAL CHARACTERISTICS

<p><b>1. Equipment Operated By:</b>  <input type="checkbox"/> Army   <input type="checkbox"/> Air Force   <input type="checkbox"/> Other  <input type="checkbox"/> Navy   <input type="checkbox"/> Marine Corps</p>	<p><b>2. Organizational Unit Designation</b></p>	<p><b>8. Equipment Data</b>                  A. Nomenclature _____ B. Serial Number _____                  C. Other Identifying Information _____  <input type="checkbox"/> Transmitter   <input type="checkbox"/> Transmitter-receiver combination (e.g.) radar, beacon, transceiver, etc.  <input type="checkbox"/> Receiver                  D. List call sign, site number or station code if applicable _____                  9. Antenna Nomenclature or Type _____ IO. Antenna Height, Geometric center of antenna above site elevation _____ feet                  11. Antenna Horizontal Motion Rate, For scanning specify RPM and percent of time used                  Scanning Rate _____                  Percent of Time _____                  12. Antenna Orientation                  A. Elevation (Indicate angle of electrical axis of lowest beam, if fixed)   <input type="checkbox"/> Plus _____ degrees   <input type="checkbox"/> Minus _____ degrees                  B. (Mark either "Fixed" or "Scanning" and complete appropriate block)  <input type="checkbox"/> Fixed   <input type="checkbox"/> Omnidirectional  <input type="checkbox"/> Other (Specify Orientation) _____  <input type="checkbox"/> Scanning   From: _____ degrees   To: _____ degrees  <input type="checkbox"/> Height Finder   <input type="checkbox"/> Rotating (360°)  <input type="checkbox"/> Tracking   <input type="checkbox"/> Horizontal Sector Scanning                  13. Antenna Polarization   <input type="checkbox"/> Horizontal   <input type="checkbox"/> Vertical</p>
<p><b>EQUIPMENT LOCATION</b></p>		<p><b>6. For Frequency Moved Equipment Only</b>  <input type="checkbox"/> Shipborne (Indicate hull number)  <input type="checkbox"/> Airborne (Indicate aircraft type)  <input type="checkbox"/> Ground Based (Indicate unit)  <input type="checkbox"/> Other (Indicate what) _____</p>
<p><b>3. City/Base</b></p>	<p><b>4. State</b></p>	<p><b>7. Site Information (For fixed equipment only)</b>                  A. Elevation (In feet above mean sea level) _____ feet                  B. Latitude Degrees Min Sec  <input type="checkbox"/> North _____   <input type="checkbox"/> South _____                  C. Longitude  <input type="checkbox"/> East _____   <input type="checkbox"/> West _____                  D. Terrain (Mark applicable items)  <input type="checkbox"/> Dry Sand &amp; Rock   <input type="checkbox"/> Streets &amp; Bldgs.  <input type="checkbox"/> Grass and/or Farmland   <input type="checkbox"/> Swampland  <input type="checkbox"/> Wooded   <input type="checkbox"/> Water  <input type="checkbox"/> Other _____                  E. Source of Data  <input type="checkbox"/> Map   <input type="checkbox"/> Survey  <input type="checkbox"/> Other _____                  F. Screening Angle (For fixed equipment only) (Mark one for each elevation)                  Elevation Screened or Blanked                  Clear Angle   30°   20°   10°   5°   0°   -2°   Other                  Degrees (Reference true north)                  0   60   120   180   240   300   360                  30   90   150   210   270   330</p>

Figure 6 - 7. Environmental Characteristics Form ( 1 of 2 )

EQUIPMENT OPERATION																													
<p><b>14. EQUIPMENT OPERATIONAL DUTY CYCLE</b> (Mark One)</p> <p><input type="checkbox"/> Equipment ON THE AIR 24 hours a day, 7 days a week. (Skip to Item 15)</p> <p><input type="checkbox"/> Equipment off at all non-designated times. Fill in (a) through (d) below</p> <p>(a) Normal Operations                      Daylight _____ Night _____                      clear low visibility _____                      the air _____                      (b) Operations during alert conditions _____ %                      (c) <input type="checkbox"/> Yes, percent of time per week on _____ %  <input type="checkbox"/> Mark here if this equipment is used primarily as a spare or back up                      (d) Indicate any weekly, monthly or seasonal changes. Also, any long term scheduling _____</p>	<p><b>17. PRIMARY EQUIPMENT USAGE</b> (Mark One)</p> <p><input type="checkbox"/> Military Operations and Training</p> <p><input type="checkbox"/> Training Only</p> <p><input type="checkbox"/> Research and Development</p> <p><input type="checkbox"/> F A A</p> <p><input type="checkbox"/> Operation is necessary for air traffic control in high density air traffic regions</p> <p><input type="checkbox"/> Equipment operation is on a non-interference basis only</p>																												
<p><b>15. POWER (Transmitters only)</b> Indicate power normally transmitted. Also indicate whether peak, average, carrier or peak envelope power is recorded below</p> <p>Power (kW) Percent of time used (Mark One)</p> <table style="width:100%; border-collapse: collapse;"> <tr> <td style="width: 15%;">0-5</td> <td style="width: 15%;">6-50</td> <td style="width: 15%;">51-95</td> <td style="width: 15%;">96-100</td> </tr> <tr> <td><input type="checkbox"/></td> <td><input type="checkbox"/></td> <td><input type="checkbox"/></td> <td><input type="checkbox"/></td> </tr> <tr> <td><input type="checkbox"/></td> <td><input type="checkbox"/></td> <td><input type="checkbox"/></td> <td><input type="checkbox"/></td> </tr> <tr> <td><input type="checkbox"/></td> <td><input type="checkbox"/></td> <td><input type="checkbox"/></td> <td><input type="checkbox"/></td> </tr> </table>	0-5	6-50	51-95	96-100	<input type="checkbox"/>	<input type="checkbox"/>	<input type="checkbox"/>	<input type="checkbox"/>	<input type="checkbox"/>	<input type="checkbox"/>	<input type="checkbox"/>	<input type="checkbox"/>	<input type="checkbox"/>	<input type="checkbox"/>	<input type="checkbox"/>	<input type="checkbox"/>	<p><b>18. FOR PULSE EQUIPMENT ONLY</b></p> <p>Pulse Width PRR(pulse Pulse Width or PRR combination) (microsec.) per sec.)</p> <table style="width:100%; border-collapse: collapse;"> <tr> <td style="width: 15%;">0-5</td> <td style="width: 15%;">6-50</td> <td style="width: 15%;">51-95</td> <td style="width: 15%;">96-100</td> </tr> <tr> <td><input type="checkbox"/></td> <td><input type="checkbox"/></td> <td><input type="checkbox"/></td> <td><input type="checkbox"/></td> </tr> <tr> <td><input type="checkbox"/></td> <td><input type="checkbox"/></td> <td><input type="checkbox"/></td> <td><input type="checkbox"/></td> </tr> </table>	0-5	6-50	51-95	96-100	<input type="checkbox"/>	<input type="checkbox"/>	<input type="checkbox"/>	<input type="checkbox"/>	<input type="checkbox"/>	<input type="checkbox"/>	<input type="checkbox"/>	<input type="checkbox"/>
0-5	6-50	51-95	96-100																										
<input type="checkbox"/>	<input type="checkbox"/>	<input type="checkbox"/>	<input type="checkbox"/>																										
<input type="checkbox"/>	<input type="checkbox"/>	<input type="checkbox"/>	<input type="checkbox"/>																										
<input type="checkbox"/>	<input type="checkbox"/>	<input type="checkbox"/>	<input type="checkbox"/>																										
0-5	6-50	51-95	96-100																										
<input type="checkbox"/>	<input type="checkbox"/>	<input type="checkbox"/>	<input type="checkbox"/>																										
<input type="checkbox"/>	<input type="checkbox"/>	<input type="checkbox"/>	<input type="checkbox"/>																										
<p><b>16. WHERE EXACT FREQUENCIES are assigned or used, indicate those frequencies. In other cases, estimate normal (operating frequency or frequencies. If more than one frequency is used, indicate approximate percentage of total operating time each frequency or frequency band is used. (Describe any schedules not covered below in Item 20)</b></p> <p>Frequency ( Megahertz) Percent of time used (Mark One)</p> <table style="width:100%; border-collapse: collapse;"> <tr> <td style="width: 15%;">0-5</td> <td style="width: 15%;">6-50</td> <td style="width: 15%;">51-95</td> <td style="width: 15%;">96-100</td> </tr> <tr> <td><input type="checkbox"/></td> <td><input type="checkbox"/></td> <td><input type="checkbox"/></td> <td><input type="checkbox"/></td> </tr> <tr> <td><input type="checkbox"/></td> <td><input type="checkbox"/></td> <td><input type="checkbox"/></td> <td><input type="checkbox"/></td> </tr> </table>	0-5	6-50	51-95	96-100	<input type="checkbox"/>	<input type="checkbox"/>	<input type="checkbox"/>	<input type="checkbox"/>	<input type="checkbox"/>	<input type="checkbox"/>	<input type="checkbox"/>	<input type="checkbox"/>	<p><b>19. MODULATION TYPES (Percentage of total operating time per Modulation Type that this equipment uses)</b></p> <p>Modulation Type Percent of time used (mark one)</p> <table style="width:100%; border-collapse: collapse;"> <tr> <td style="width: 15%;">0-5</td> <td style="width: 15%;">6-50</td> <td style="width: 15%;">51-95</td> <td style="width: 15%;">96-100</td> </tr> <tr> <td><input type="checkbox"/></td> <td><input type="checkbox"/></td> <td><input type="checkbox"/></td> <td><input type="checkbox"/></td> </tr> <tr> <td><input type="checkbox"/></td> <td><input type="checkbox"/></td> <td><input type="checkbox"/></td> <td><input type="checkbox"/></td> </tr> </table>	0-5	6-50	51-95	96-100	<input type="checkbox"/>	<input type="checkbox"/>	<input type="checkbox"/>	<input type="checkbox"/>	<input type="checkbox"/>	<input type="checkbox"/>	<input type="checkbox"/>	<input type="checkbox"/>				
0-5	6-50	51-95	96-100																										
<input type="checkbox"/>	<input type="checkbox"/>	<input type="checkbox"/>	<input type="checkbox"/>																										
<input type="checkbox"/>	<input type="checkbox"/>	<input type="checkbox"/>	<input type="checkbox"/>																										
0-5	6-50	51-95	96-100																										
<input type="checkbox"/>	<input type="checkbox"/>	<input type="checkbox"/>	<input type="checkbox"/>																										
<input type="checkbox"/>	<input type="checkbox"/>	<input type="checkbox"/>	<input type="checkbox"/>																										
<p><b>20. PROVIDE ANY ADDITIONAL INFORMATION, OR REMARKS, THAT SHOULD BE CONSIDERED</b> (Use separate sheet if necessary)</p>																													
<p>NAME, GRADE OR RANK, TITLE AND ORGANIZATION OF PERSON COMPLETING THIS FORM.</p> <p>(NAME) _____ Grade or Rank _____</p> <p>(TITLE) _____</p> <p>(ORGANIZATION) _____</p>																													

AI AF 242

Figure 6 - 7. Environmental Characteristics Form ( 2-of 2 )

Table 6-3. Delineation of Environmental Characteristics Form

ENTRY	DESCRIPTOR	EXAMPLE
<ol style="list-style-type: none"> <li>1. Equipment operated by</li> <li>2. Organizational unit designation</li> <li>3. City/base</li> <li>4. State</li> <li>5. Equipment mobility</li> <li>6. For frequently moved equipment only</li> <li>7. Site information                             <ol style="list-style-type: none"> <li>a. Elevation</li> <li>b. Latitude</li> <li>c. Longitude</li> <li>d. Terrain</li> <li>e. Data source</li> <li>f. Screening angle</li> </ol> </li> <li>8. Equipment data                             <ol style="list-style-type: none"> <li>a. Nomenclature</li> <li>b. Serial number</li> <li>c. Other identifying information</li> <li>d. List all sign, site no., station code, if applies</li> </ol> </li> <li>9. Antenna nomenclature or type</li> <li>10. Antenna height</li> </ol>	<p>Cognizant operating service                      Specific operating group                      Name of nearest base and/or city</p> <p>Check one                      Check one</p> <p>Feet above mean sea level                      Degrees, minutes, seconds                      Degrees, minutes, seconds                      Type of terrain</p> <p>Check one                      Mark sector for each elevation</p> <p>AN or commercial designation                      Equipment serial number                      Check one</p> <p>Specify military or commercial designation                      Geometric center of antenna above local terrain to nearest foot</p>	<p>USN                      387th Recon. Sqdn                      Cherry Point, NAS,                      North Carolina                      Fixed                      Land based</p> <p>400 ft                      40°30'22"N.                      22°15'0.8" W.                      Water; rocks                      Map</p> <p>AN/FPS-3</p> <p>Site no. 93                      35 feet, 2.5 feet</p>

Table 6-3. Delineation of Environmental Characteristics Form (Continued)

ENTRY	DESCRIPTOR	EXAMPLE
11. Antenna horizontal motion rate  12. Antenna orientation a. Elevation b. Azimuth 13. Antenna polarization 14. Equipment operation duty cycle 15. Power (XMTR only)  16. Frequencies  17. Preliminary equip. usage 18. Pulse equipment  19. Modulation types 20. Remarks	<p>For scanning specify RPM and percent of time used</p> <p>Indicate angle of electrical axis of lowest beam if fixed                      Mark either "fixed" or "scanning" &amp; complete appropriate block                      Specify nominal polarization and alternate when applicable                      Mark one, and fill in (a) through (d) as appropriate                      Indicate power normally used and whether it is average, carrier or peak envelope power                      Give exact frequency where assigned and used; otherwise, normal operating frequency, + % of time                      Description of equipment use                      Pulse characteristics and percentage of use for each set of characteristics                      Type of modulation and percentage of use                      Provide any additional pertinent information or remarks                      (Name, grade, or rank, title and organization of person completing form)</p>	<p>S R. = 6 r/min % of time used = 22%</p> <p>5kW, 51-95%                      20kW, 6-50%                      30 MHz, 96-100%</p> <p>24 μ sec; 1000 pps; 96-100%                      22 μ sec; 224 pps; 0-6%                      FM; 51-95%</p> <p>Joe Smith, Ensign, USN                      Com. Engineers,</p>

Receiver \_\_\_\_\_  
Location \_\_\_\_\_  
Date of Form \_\_\_\_\_

**Rapid Cull Form**

No.	Nomenclature or Other Designation	Frequency MHz	Remarks
1			
2			
3			
4			
5			
6			
7			
8			
9			
10			
11			
12			
13			
14			
15			
16			
17			
18			
19			
20			

A1AF 240

Figure 6 - 8. Rapid Cull Form

The flow diagram shown in figure 6-9 can be used to quickly examine the frequency relationships and determine the transmitters that can be eliminated as potential sources of interference and those that should be retained for further analysis.

The procedure has been designed so that the calculations required for each step need only be made once for each receiver. These values can then be compared rapidly with the fundamental frequency of any number of transmitters without further calculations. The harmonics of each transmitter are taken into account in the receiver calculations.

In cases where a large number of equipments exist or time is at a premium, a very rapid first sorting may be desired. For this situation, the portion of the diagram contained in the dashed section should be eliminated. While the existence of certain frequency relationships within this portion may cause interference, the probability is much lower that interference will exist for these relationships than those in the remaining portion of the diagram. In performing this very rapid sorting operation, any transmitter for which the process leads into the dashed area may be eliminated as a possible source of interference.

In a complex such as a Naval Shore Station, transmitters are often operated on various frequencies depending on the particular requirement. For example, a certain transmitter may be used one day on a tactical frequency and the next day on a point-to-point frequency. Therefore, when examining possible sources of interference to a receiver, it is almost impossible to specify the operating frequency for each transmitter.

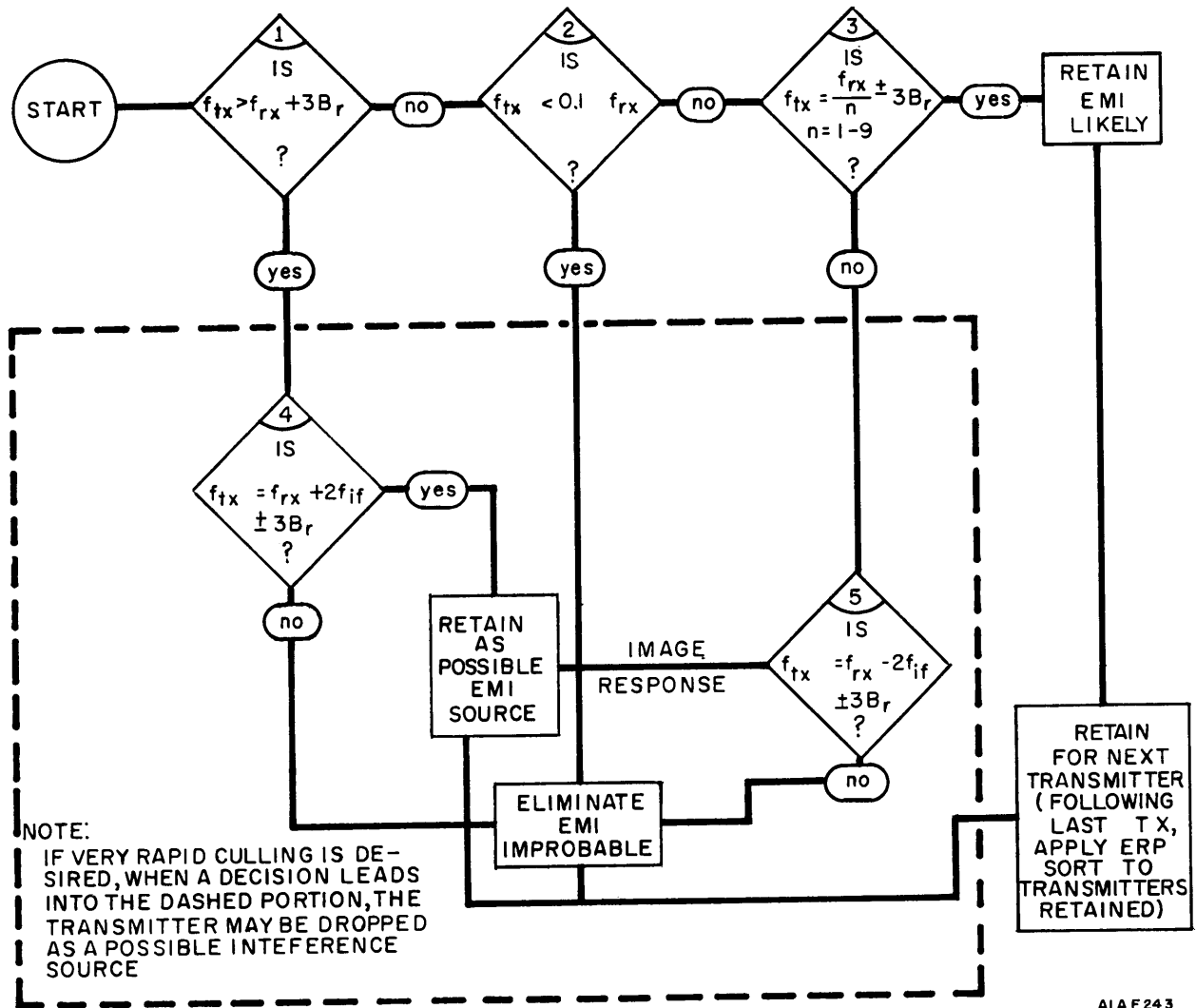

Figure 6 - 9. Flow Diagram for Rapid Frequency Sorting

The rapid frequency sort, with minor modifications, can be used to eliminate from further consideration transmitters that will not cause interference, no matter where within their frequency range they are operating.

The modifications are (refer to figure 6-9):

- (1) Substitute the lowest operating frequency of the transmitter  $f_{TX}$  in diamond (1)
- (2) Substitute the highest operating frequency for  $f_{TX}$  in diamond (2)
- (3) If any of the receiver frequency bands determined in diamond (3) fall within the transmitter frequency band, operation of the transmitter on these frequencies may cause interference.
- (4) For the more detailed frequency sort, it should be determined if any of the transmitter frequencies equal the  $f_{TX}$  values in diamonds (4) and (5), if so, operation on these frequencies may cause interference.

In addition to its use for eliminating transmitters from further analysis as interference sources, this flow diagram can be used to select frequency bands for a transmitter that will not interfere with any of the subject receivers. If sufficient frequency channels are available, this process will facilitate frequency assignments, such that the possibility of interference will be very small.

#### 6.4.2 Effective Radiated Power and Propagation Loss Sorting

In addition to the frequency sorting just discussed, additional surviving transmitters can be eliminated as potential sources of interference by considering the Effective Radiated Power (ERP) of the transmitter.

In order for a transmitter to interfere with the operation of a receiver, it must radiate a signal that will exceed a certain level at the receiver terminals. This level is determined by the strength of the desired signal, frequency of the signal, sensitivity of receiver, and many other considerations.

However, by calculating the transmitter signal strength at the receiver and assuming the receiver to be very sensitive, it is possible to eliminate transmitters because their radiated power is inadequate to cause interference to the receiver under study.

A nomogram (figure 6-10) has been prepared which can be used to rapidly eliminate those transmitters which will not cause interference. In order to use the nomogram, the required variables are:

- a. Transmitter power in dBm
- b. Sum of antenna gains for transmitter and receiver
- c. Path loss is a function of frequency and distance between transmitter and receiver. It can be obtained from figure 6-11.

To use the nomogram: (1) draw a line from the transmitter power on Line 1, through the gain value on Line 2 to Line 3; (2) draw a line from the intersection on Line 3 through the path loss value on Line 4 to Line 5; (3) if the final point lies below the criteria for the type receiver being considered it may be rejected as a possible source of interference.

The criteria has been set so that no transmitters which interfere with the receiver will be rejected.

#### 6.4.3 Geographic Sorting

Another method of eliminating probable non-interfering transmitters is based on an analysis of the terrain between the transmitters and the receiver under consideration. When it can be determined that the receiver is beyond the Radio-Line-Of-Site (RLOS) of a transmitter, the transmitter can be eliminated as a possible source of interference. The term Radio-Line-Of-Site (RLOS) refers to the unobstructed propagation path of electromagnetic

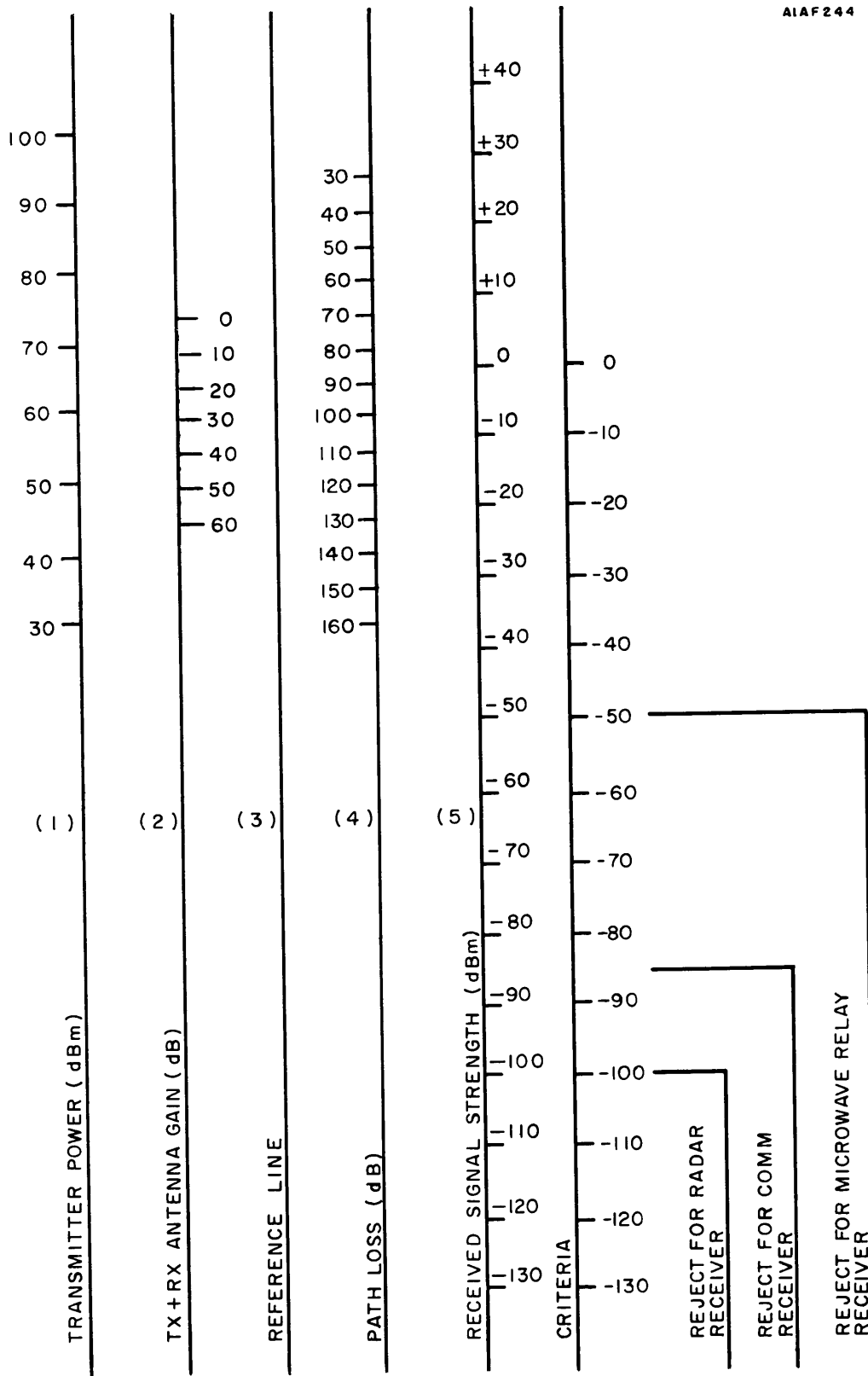

Figure 6 - 10. Nomogram for ERP Rapid Sorting



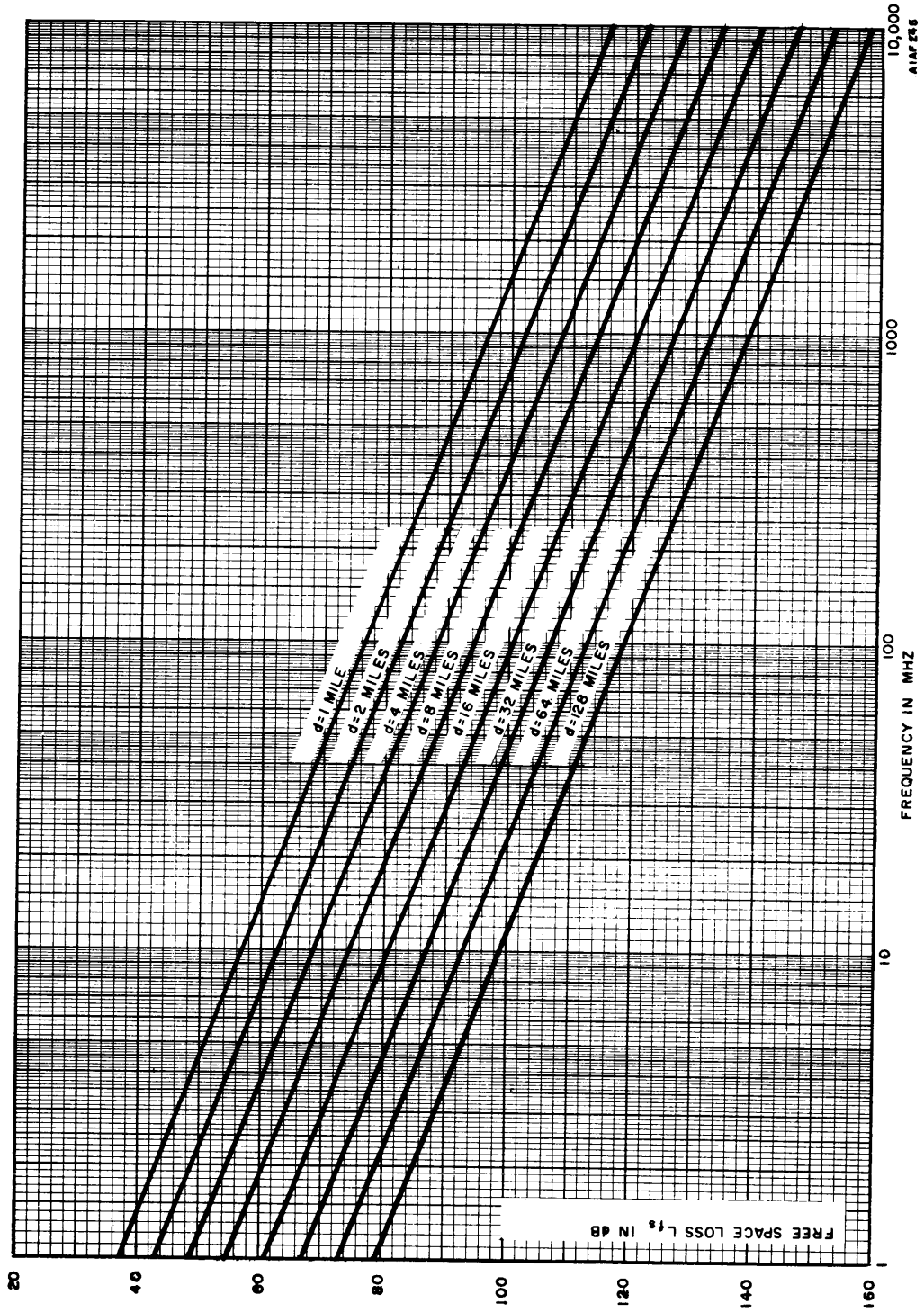

Figure 6 - 11. Free Space Propagation Loss

energy through the "standard atmosphere." The standard atmosphere is an atmosphere whose index of refraction varies linearly with height at a specific rate. The standard atmosphere is generally used for initial planning or site analysis since the composition and index of refraction of the actual atmosphere is a time-varying parameter, which is a function of season, temperature, moisture content, and other factors. It can be shown that the index of refraction for the standard atmosphere is such that if the curvature of the earth is represented as  $4/3$ 's its own radius (i.e.,  $4/3 \times 3960$  mi) the propagation rays emanating from an emitter, can be drawn as a straight line. Therefore, for convenience,  $4/3$  earth radius graph paper is used to analyze the propagation profiles involved in an interference analysis.

The RLOS for an emitter or radiated propagation over a smooth earth is limited by the point at which the ray is tangent to the earth. The region beyond this point (diffraction and/or scattering regions) is masked or obscured and receives little or no significant radiated power, insofar as geographical sorting is concerned.

In view of the short distances between equipments and the relatively flat terrain which is normally selected for a station, this method of sorting will have very limited application.

## 6.5 DISCRETE PREDICTION TECHNIQUES

Upon completion of the rapid sorting, the transmitters that have not been eliminated are considered likely sources of interference which require further analysis. Therefore, it is necessary to make a separate analysis of the relationships between each of these transmitters and the receiver under study.

This analysis consists of completing the calculation sheet whose entries cover transmitter, receiver, and propagation characteristics associated with each transmitter-receiver pair.

The EMI prediction formula readily lends itself to a ledger-sheet type of tabulation. Therefore, each of the variables is made an entry on the computation sheet shown in figure 6-1. Each of the entries in Columns "A" or "B" represents an operational condition associated with the potentially interfering transmitter-receiver pair being analyzed. Columns "C" and "D" are used either for totaling the values in Columns "A" and "B" or for inserting measured values of certain major parameters. Table 6-4 contains instructions identifying the data required for each line entry on the EMI prediction form. The table, together with the calculation sheet described herein and the referenced data sources, are all that is required to perform an EMI prediction calculation.

The top portion of the calculation sheet is simply a general information section, and as such, establishes the identity of the major elements of the particular prediction. Details of the individual sections are described in the following paragraphs.

### 6.5.1 Transmitter

This section presents the methods of calculating the effects of each of the transmitter system elements, i.e., transmitter power output, antenna gain and transmission line loss as they pertain to a potential interference situation. For the purposes of this report, transmitter systems have been arbitrarily classified as either radar or communications types.

The explanation of the individual transmitter entries is presented below.

#### o LINE 1.1, TX POWER (Fill in Radar TX or Communications TX Section)

This block of entries is used to calculate the amount of power being transmitted at the frequency of the interference. It is necessary to select and complete the appropriate portion of either the radar transmitter section or the communications transmitter section. The transmitter output power is a function of the transmitter frequency and quantitative description of the level, (i.e., watts, dBW, dBm). This information can be obtained from the manufacturer's specifications or operations manuals.

Table 6-4. Instructions for Making Entries in the EMI Prediction Calculation Sheet

REFERENCE ON CALCULATION SHEET LINE ENTRY AND SYMBOL	INSTRUCTIONS FOR DETERMINING DATA	DATA SOURCE
1. XMTR - identity 2. RCVR - identity 3. Code 4. Date of form 5. XMTR and RCVR 6. XMTR site and RCVR site  Separation - R	Standard AN nomenclature Standard AN nomenclature This prediction number Today's date Same as items 1 and 2 Sites of items 1 and 2	C-E characteristics data sheet C-E characteristics data sheet
7. XMTR frequency $f_t$ (MHz) RCVR frequency $f_r$ (MHz) 8. Frequency of interference $-f_i$ (MHz)          $f_i$ is _____ function of $f_t$	Distance between items 1 and 2 statute miles Operating frequency for item 1 Operating frequency for item 2 A. Calculate harmonics of $f_t$ - $2f_t, 3f_t, \dots, nf_t$ B. At each frequency of interest, determine the frequency spread for: (1) XMTR emission spectrum $f_t, 2f_t, 3f_t, \dots, nf_t$ (2) RCVR selectivity response - $f_r$ C. Determine whether (1) $f_r = f_t, 2f_t, 3f_t, \dots, nf_t$ (2) Any frequency in the spreads for XMTR [B(1)] falls in the spread for RCVR [B(2)]. The RCVR frequency that satisfies (1) or (2) is the item $f_i$ Determine from "C" above $f_i = f_t, 2f_t, 3f_t, \dots$ or $nf_t$ or $f_i = f_t \pm \Delta f, 2f_t \pm \Delta f, \dots$ or $nf_t \pm \Delta f$	Environmental characteristics form Environmental characteristics form C-E characteristics data sheet C-E characteristics data sheet Not applicable  C-E characteristics data sheet  N/A  N/A
9. XMTR antenna polarization RCVR antenna polarization	Horizontal, vertical, or other Horizontal, vertical, or other	C-E characteristics data sheet C-E characteristics data sheet
10. Fundamental cochannel interference	If $f_i = f_t$ (item 8), determine A. $P_t$ (watts) B. $(10 \log P_t) + 30$ (+dBm)	C-E characteristics data sheet N/A
11. Fundamental adjacent channel interference	If $f_i = f_t \pm \Delta f$ (item 8), determine $(10 \log P_t) + 30$ (+dBm) as in item 10	N/A
12. ( $\Delta f$ = off-center frequency - MHz)	Find $\tau$ = pulse width ( $\mu$ sec) Calculate $40 \log \pi \tau \Delta f$ (-dB) Find $T_r$ = pulse rise time ( $\mu$ sec) $T_f$ = pulse fall time ( $\mu$ sec) $T_r + T_f$ Calculate $k = \frac{T_r + T_f}{2\tau}$ and $20 \log k$ (-dB)	C-E characteristics data sheet N/A C-E characteristics if available C-E characteristics if available If $T_r$ and $T_f$ not available use $K = 0.1$
12. and 13. Alternate	For $\Delta f$ and selected $k$ (=0.1), read power correction (-dB) in Figure 6-13	

Table 6-4. Instructions for Entries in the EMI Prediction Calculation Sheet (Continued)

REFERENCE ON CALCULATION SHEET LINE ENTRY AND SYMBOL	INSTRUCTIONS FOR DETERMINING DATA	DATA SOURCE
14. Harmonic cochannel interference 15. dB down from $f_o$	A. $(10 \log P_t + 30)$ (+dBm) as in item 10 B. Value of n C. dB down due to harmonic roll-off for value of n	N/A N/A Characteristics sheet or Table 6-5
16. Harmonic adjacent channel interference	If $f_i = hf_t \pm \Delta f$ (item 8) determine	N/A
17. ( $\Delta f$ = off-center frequency MHz)	A. $(10 \log P_t) + 30$ (+dBm) as in item 10 B. dB down as in item 15C C. $40 \log \pi \Delta f$ (-dB) as in item 12 D. $20 \log K$ (-dB) as in item 13 Same as items 12 and 13 alternate	Same as item 15 C Same as item 12 Same as item 13 Figure 6-13
18. and 19 alternate		
20. Same as item 10 for a communication XMTR		
21. Same as item 14 for a communications XMTR		
22. Same as item 15 for a communications XMTR		
23. XMTR transmission line loss - $L_t$ (-dB)	Calculate $L = L\alpha$ where $L$ = total line length (in 100') $\alpha$ = attenuation/100' Add to $L$ other RF component losses, which are known or can be estimated, to obtain $L_t$ (-dB). If undeterminable, use $L_t = 2$ dB.	Figures 6-14, 6-15  N/A  N/A
24. XMTR antenna gain	Nominal gain (+dB)	C-E characteristics data sheet or figure 6-16 and 6-17
25. Loss due to off-axis pointing	Determine antenna beamwidth, $b^\circ$ Determine antenna misalignment between XMTR and RCVR in degrees and in number of antenna beamwidths. Determine loss (-dB)	C-E characteristics data sheet
26. Loss due to near field effect = $C_{FR}$ (-dB)	Determine Fresnel boundary distance ( $d_{min}$ ) If $R$ (item 6) $< d_{min}$ , calculate x and y Read $C_x$ and $C_y$ , page from figure 6-23. Find $C_{FR} = C_x + C_y$ (-dB)	Figure 6-22  Figure 6-23 N/A
27. Subtotal, column A	Add + dB in column A for XMTR	N/A
28. Subtotal, column B	Add -dB in column B for XMTR	N/A
29. Total, item 27 - item 28	Subtract to obtain ERP in dBm and enter in column C (+) or D(-)	
30. Wave spreading	For $R$ (item 6), determine loss (-dB)	Figure 6-25
31. Reflection field loss = A (-dB)	Calculate A (-dB) by using figure 6-26	Figure 6-26
32. Diffraction field loss = D (-dB)	N/A	N/A
33. Scatter field	N/A	N/A
34. Subtotal, column A	Add + dB in column A for propagation	N/A
35. Subtotal, column B	Add - dB in column B for propagation	N/A
36. Total, item 34 - item 35	Subtract to obtain propagation losses in dB and enter in column D(-)	N/A
37. Power density at RCVR, item 29 - item 36	Subtract to obtain power density at the RCVR site ( $\text{dBm}/\text{m}^2/\text{MHz}$ )	N/A
38. Loss due to polarization mismatch	Use item 9 to determine loss (dB)	Table 6-9
39. RCVR effective area	If $A_R$ is known, compute $10 \log A_R$ (dB)	
40. RCVR frequency	If $A_R$ is not known, read $20 \log f$ from figure 6-34(-dB)	Figure 6-34

Table 6-4. Instructions for Entries in the EMI Prediction Calculation Sheet (Continued)

REFERENCE ON CALCULATION SHEET LINE ENTRY AND SYMBOL	INSTRUCTIONS FOR DETERMINING DATA	DATA SOURCE
41. RCVR antenna gain 42. Loss due to off-axis pointing 43. Loss due to near field effect 44. RCVR transmission line loss - $L_R$ (-dB) 45. Subtotal, column A	Repeat item 24 for RCVR (+dB) Repeat item 25 for RCVR (-dB) Repeat item 26 for RCVR (-dB) Repeat item 23 for RCVR Add +dB column A for items 39-41 + 38.6 dB	Same as item 24 Same as item 25 Same as item 26 Same as item 23 N/A
46. Subtotal, column B	Add - dB in column B for items 38, 39, 40, 42, 43, and 44	N/A
47. Total, item 45 - item 46	Subtract to obtain RCVR transfer effect in and enter in column C (+) or D(-)	N/A
48. RCVR interference power, item 37 ± item 47	Add or subtract to obtain power at RCVR input terminals in dBm and enter in column C(+) or D(-)	N/A
49. Fundamental cochannel interference	If $BW_{RCVR} < \frac{2}{T}$ , calculate $10 \log (0.5 BW_{RCVR})$ (dB)	C-E characteristics data sheet
50. Fundamental adjacent channel interference	Calculate $10 \log (BW_{RCVR})$ (dB)	C-E characteristics data sheet
51. Harmonic cochannel interference	If $BW_{RCVR} < \frac{2}{T}$ , calculate $10 \log (0.5 BW_{RCVR})$ (dB)	C-E characteristics data sheet
52. Harmonic adjacent channel interference	Calculate $10 \log (BW_{RCVR})$ (dB)	C-E characteristics data sheet
53. $10 \log (BW_{RCVR})$	Same as item 50 (dB)	C-E characteristics data sheet
54. $10 \log (BW_{RCVR})$	Calculate for communications, XMTR (dB)	C-E characteristics data sheet
55. RCVR sensitivity (-dBm)	Determine from spec. data or calculate in accordance with figure 6-37	C-E characteristics data sheet
56. Subtotal, column A	Add + dB in column A for items 49-55	N/A
57. Subtotal, column B	Add - dB in column B for items 49-54	N/A
58. Total, item 56 - item 57	Subtract to obtain adjusted RCVR threshold and enter in column C(+dBm) or D (-dBm)	N/A
59. $\frac{I}{N}$ Ratio, item 48 + item 58 N	Add algebraically (watching all signs) to obtain effective interference power at RCVR input terminals referenced to adjusted RCVR threshold in dB and enter in column C(+) or D(-)	N/A
60. Assumed or known RCVR $\frac{S}{N}$ (+dB)	If RCVR $\frac{S}{N}$ is known, enter in column C.	C-E characteristics data sheet
	If RCVR $\frac{S}{N}$ is not known, estimate or calculate value using equation 27, and table 6-10	
61. Predicted $\frac{S}{I}$ , item 60 - item 59	If item 59 $> 0$ , subtract and enter in column C (+) or D(-)	N/A

o Radar Transmitters

o LINE 1.1.1, FUNDAMENTAL COCHANNEL INTERFERENCE ( $f_r = f_t$ )

The amount of power transmitted ( $P_t$ ) is assumed to be the full rated power of the radar unless known otherwise. For multibeam radars, this is the power delivered to the lower antenna beam. For example, if a one megawatt radar is being considered, Line 1.1.1.1 becomes  $(10 \log 1 \times 10^6) + 30 = 90$  dBm. Thus, for this case, the transmitted power level is 90 dBm.

o LINE 1.1.2, FUNDAMENTAL ADJACENT CHANNEL INTERFERENCE

In this case, the amount of power existing at some frequency adjacent to the carrier frequency becomes a function of the transmitter modulation side band power density distribution ( $P_{tr}$ ). The  $P_{tr}$  of a typical radar is shown in figure 6-12. This distribution is a function of the characteristics of the modulating pulse. The amount of power existing at a specific frequency within this distribution may be calculated by assuming that the full rated power exists (line 1.1.2.1) and then modifying this accordingly (lines 1.1.2.2 and 1.1.2.3).

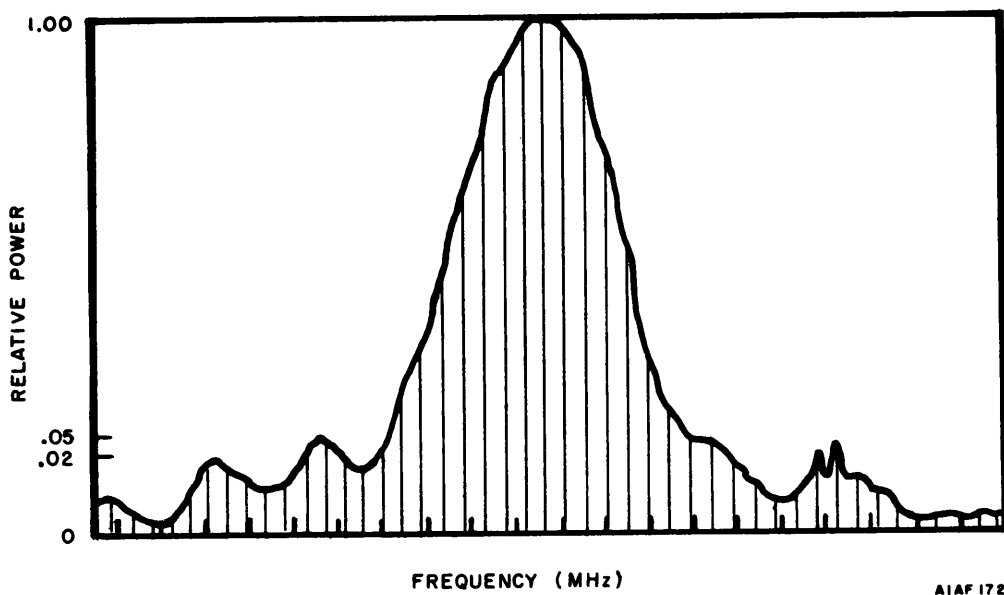

Figure 6 - 12. Sideband Power Density Distribution

o LINE 1.1.2.1,  $(10 \log P_t) + 30$  (See discussion of Line 1.1.1.1)

o LINES 1.1.2.2  $-40 \log (\pi\tau\Delta f_{\text{MHz}})$  and 1.1.2.3  $-20 \log K$

These entries represent the necessary modifying factors for transmitted power of a rectangular pulsed radar for case 1.1.2. Since in any real situation no pulse has zero rise time, these rectangular pulses resemble trapezoids. If K is now defined as representing the pulse shape, factor then  $P_{tr}$  for a pulsed radar may be stated as an equation, thusly:

$$10 \log P_{tr} = 10 \log P_t - 20 \log K - 40 \log \pi\tau\Delta f_{\text{MHz}} \tag{6-5}$$

where:

$$K = \frac{T_r + T_f}{2\tau} \text{ in similar units} \\ \text{e.g., msec, } \mu\text{sec, etc.}$$

When K cannot be determined for a selected radar, a value of 0.1 should be used. As can be seen, Lines 1.1.2.2 and 1.1.2.3 represent Equation 6-5 and should only be filled in if the radar transmitter in question is a trapezoidal pulse modulated radar. Figure 6-13 represents the distribution of the side bands for pulse modulation. The pulse can have a rectangular, trapezoidal, cosine or cosine squared shape. Consequently, for these pulse shapes,  $P_{tr}$  can be determined directly from figure 6-13 and inserted in Column B in lieu of Lines 1.1.2.2 and 1.1.2.3.

o LINES 1.1.3, HARMONIC COCHANNEL INTERFERENCE and 1.1.4, HARMONIC ADJACENT CHANNEL INTERFERENCE

These harmonic cases directly parallel their fundamental frequency counterparts with the exception that the additional dB suppression of the harmonic peak from the fundamental is added. While these harmonics can be modeled theoretically, their existence and level cannot be predicted with very much accuracy. Therefore, it is necessary to use empirical data for the radar harmonic emissions. This information may be obtained from the manufacturer or from manuals for the radar in question. Where specific harmonic levels are not available for a certain radar, the values shown in table 6-5 may be used.

Table 6-5. Harmonic Levels of Communications and Radar Equipment

RELATIVE TRANSMITTER POWER OUTPUT FROM COMMUNICATIONS EQUIPMENT AND ERP OF RADARS (IN UNITS OF dB BELOW FUNDAMENTAL)				
Harmonic Number	Communications			Radar
	AM	FM	SSB	
2	49	67	56	48
3	65	77	81	57
4	76	76	87	62
5	80	79	93	66
6	82	78	88	68
7	82	82	90	72
8	83	81	88	74
9	87	85	90	76
10	85	84	90	78

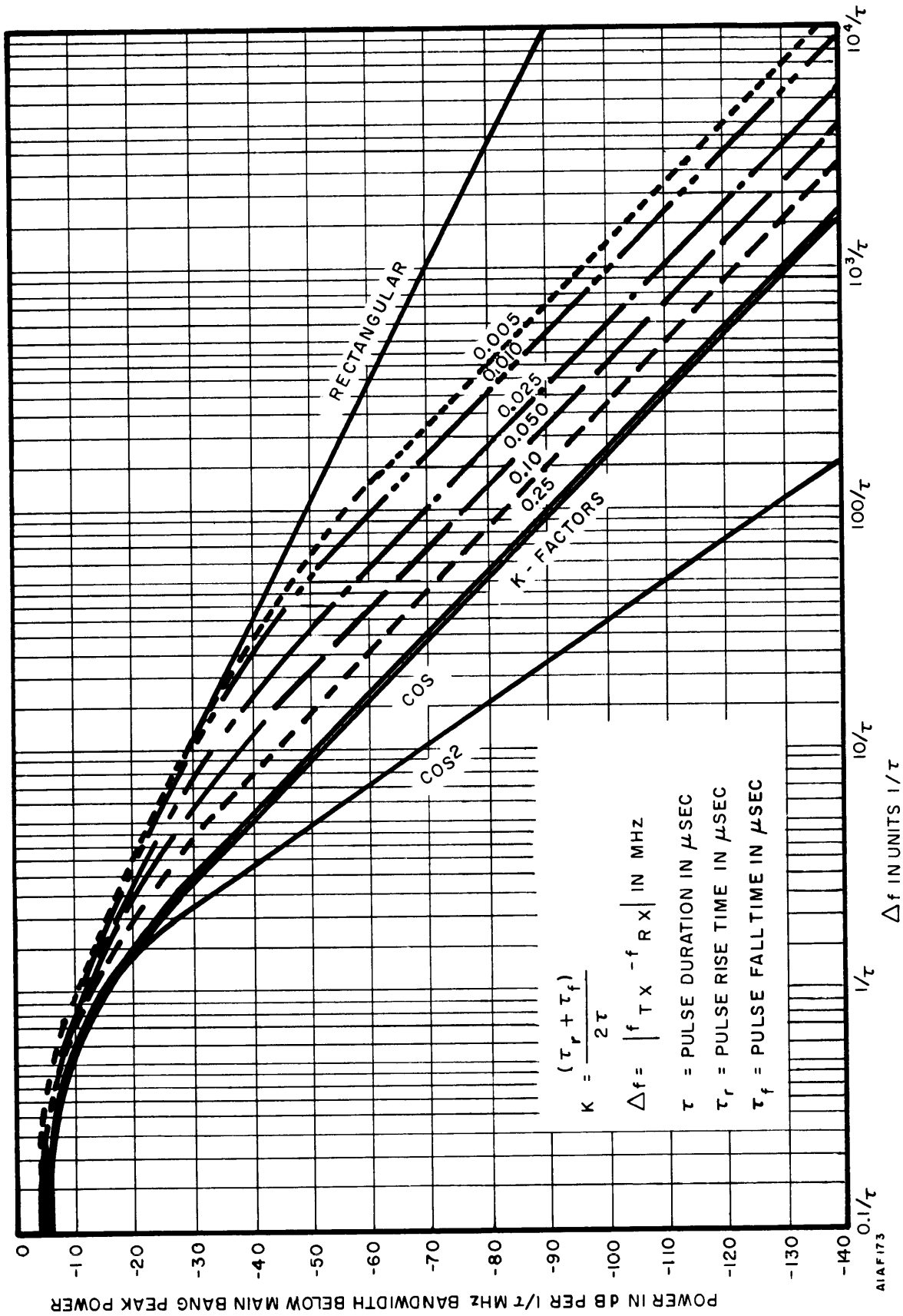

Figure 6 - 13. Transmitter Power Spectral Density vs. Off-Frequency Displacement for Pulse Modulated Signals



o Communications Transmitters

Interference from a communications transmitter is assumed to exist in this report only when one of the following two situations exists: (1) the communications transmitter and the subject receiver are operating at the same frequency, i.e., fundamental cochannel interference; or (2) the receiver is operating at a frequency which is a harmonic of the transmitter.

o LINE 1.1.5, FUNDAMENTAL COCHANNEL INTERFERENCE ( $f_r = f_t$ ) See discussion under 1.1.1

o LINE 1.1.6, HARMONIC COCHANNEL INTERFERENCE See discussion under 1.1.3

o LINE 1.2, TX TRANSMISSION LINE LOSS,  $L_t$  (dB)

Unless otherwise known, this entry is an engineering estimate based on the attenuation of the transmission line per unit length, the length of transmission line, the number of butt and/or flange joints, and the transmission loss of components such as rotary joints, (TR) switches and suppression filters. Figure 6-14 shows the attenuation in dB per 100 feet for various types of waveguides. Figure 6-15 shows the attenuation in dB per foot versus operating frequency for various types of RF cables. When the measured ERP is used as a basis for determining the transmitting power, the transmission line loss in Line 1.2 is set equal to zero, since it is already contained in the ERP.

o LINE 1.3, TX ANTENNA GAIN,  $G_t$  (dB)

This entry represents the transmitter directional antenna gain expressed in dB above isotropic. In a cochannel or adjacent channel situation where both the transmitting and the receiving antennas are located in the far field of each other, and where the antenna beams are pointing at each other (if applicable), the rated or nominal gain of each antenna applies. However, this optimum situation frequently does not prevail, such as: (1) in cases where one or both of the C-E equipments have scanning antennas, (2) where one of the equipments is a microwave relay link, (3) where the equipments are collocated at the same physical site, and (4) where the transmitting and receiving equipments operate at substantially different frequencies. Under these and other situations, the following gain correction factors have been included on the form shown in Figure 6-1 and are completed where applicable: off-axis antenna beam pointing losses, and near-field defocusing effects.

If the antenna gain is not available, it may be estimated by:

$$G_t = \frac{27,000}{\Theta_h \Theta_v} \quad (6-6)$$

where:

$G_t$  = the numerical gain of the antenna

$\Theta_h$  = horizontal beamwidth of the antenna in degrees

$\Theta_v$  = vertical beamwidth of the antenna in degrees

Equation 6-6 has been solved and plotted as a nomogram in Figure 6-16. If, however, the antenna beamwidths are not known, they may be determined by using equation:

$$\Theta^\circ = \frac{70\lambda}{d} \quad (6-7)$$

where:

$\lambda$  = the wavelength at the frequency at which the antenna is being operated

$d$  = the dimension of the antenna in the h or v direction, as applicable.

A-N TYPE	MATES WITH FLANGE Cover	MATE- RIAL	INTERNAL DIMENSIONS	RECOMMENDED OPERATING RANGE TE <sub>10</sub> MODE				CUTOFF		CALC ATTN		CALC MAX cw	
				Frequency kmc/sec	Wavelength Air cm	Wavelength Guide cm	Wavelength Guide in	Freq. KMHZ	Wave- length cm	Low Freq.	High Freq.	Low Freq.	High Freq.
RG 69/U RG 103/U	UG-417A/U UG-417A/U	Brass Alum.	6.500x3.250	1.12- 1.70	26.766-17.634	45.706-20.857	17.994-8.212	.908	33.020	.424 .269	.284 .178	11.9	17.2
RG 104/U RG 105/U	UG-435A/U UG-437A/U	Brass Alum.	4.300x2.150	1.70- 2.60	17.634-11.530	29.878-13.575	11.763-5.344	1.372	21.844	.788 .501	.516 .330	5.2	7.5
RG 112/U RG 113/U	UG-553/U UG-554/U	Brass Alum.	3.400x1.700	2.20- 3.30	13.626- 9.084	22.175-10.681	8.730-4.205	1.736	17.272	.877 .751	.572 .492	3.5	4.7
RG 48/U RG 75/U	UG-53/U UG-584/U	Brass Alum.	2.840x1.340	2.60- 3.95	11.530- 7.589	19.181- 8.924	7.552-3.513	2.078	14.427	1.48 .940	1.01 .641	2.2	3.2
RG 49/U RG 95/U	UG-149A/U UG-407/U	Brass Alum.	1.872x0.872	3.95- 5.85	7.589- 5.124	12.594- 6.083	4.958-2.395	3.152	9.510	2.79 1.77	1.93 1.22	1.4	2.0
RG 50/U RG 106/U	UG-344/U UG-441/U	Brass Alum.	1.372x0.622	5.85- 8.20	5.124- 3.656	7.560- 4.294	2.976-1.691	4.301	6.970	3.85 2.45	3.08 1.94	.56	.71
RG 51/U RG 68/U	UG-51/U UG-138/U	Brass Alum.	1.122x0.497	7.05-10.00	4.252- 2.998	6.385- 3.525	2.514-1.388	5.259	5.700	5.51 3.50	4.31 2.74	.35	.46
RG 52/U RG 67/U	UG-39/U UG-135/U	Brass Alum.	0.900x0.400	8.20-12.40	3.656- 2.418	6.088- 2.848	2.397-1.121	6.557	4.572	8.64 5.49	6.02 3.83	.20	.29
RG 91/U RG 107/U	UG-419/U UG-541/U	Brass Silver	0.622x0.311	12.40-18.00	2.418- 1.665	3.754- 1.960	1.478- .772	9.487	3.160	12.8 6.14	11.2 5.36	.12	.16
RG 53/U RG 121/U RG 66/U	UG-595/U UG-597/U UG-596/U	Brass Alum. Silver	0.420x0.170	18.00-26.50	1.665- 1.131	2.664- 1.334	1.049- .525	14.048	2.134 13.3	27.7 17.6 9.50	19.8 12.6 9.50	.043	.058
RG 96/U	UG-599/U	Silver	0.280x0.140	26.50-40.00	1.131- .749	1.866- .882	.735- .347	21.075	1.422	21.9	15.0	.022	.031
RG 97/U	UG-383/U	Silver	0.224x0.112	33.00-50.00	.909- .600	1.508- .705	.549- .278	26.342	1.138	31.0	20.9	.014	.020
RG 98/U	UG-385/U	Silver	0.148x0.074	50.00-75.00	.600- .400	.994- .472	.391- .186	39.864	.752	52.9	39.1	.0063	.0090
RG 99/U	UG-387/U	Silver	0.122x0.061	60.00-90.00	.500- .333	.844- .395	.332- .156	48.351	.620	93.3	52.2	.0042	.0063

AIAF279

Figure 6 - 14. Standard Waveguide Characteristics



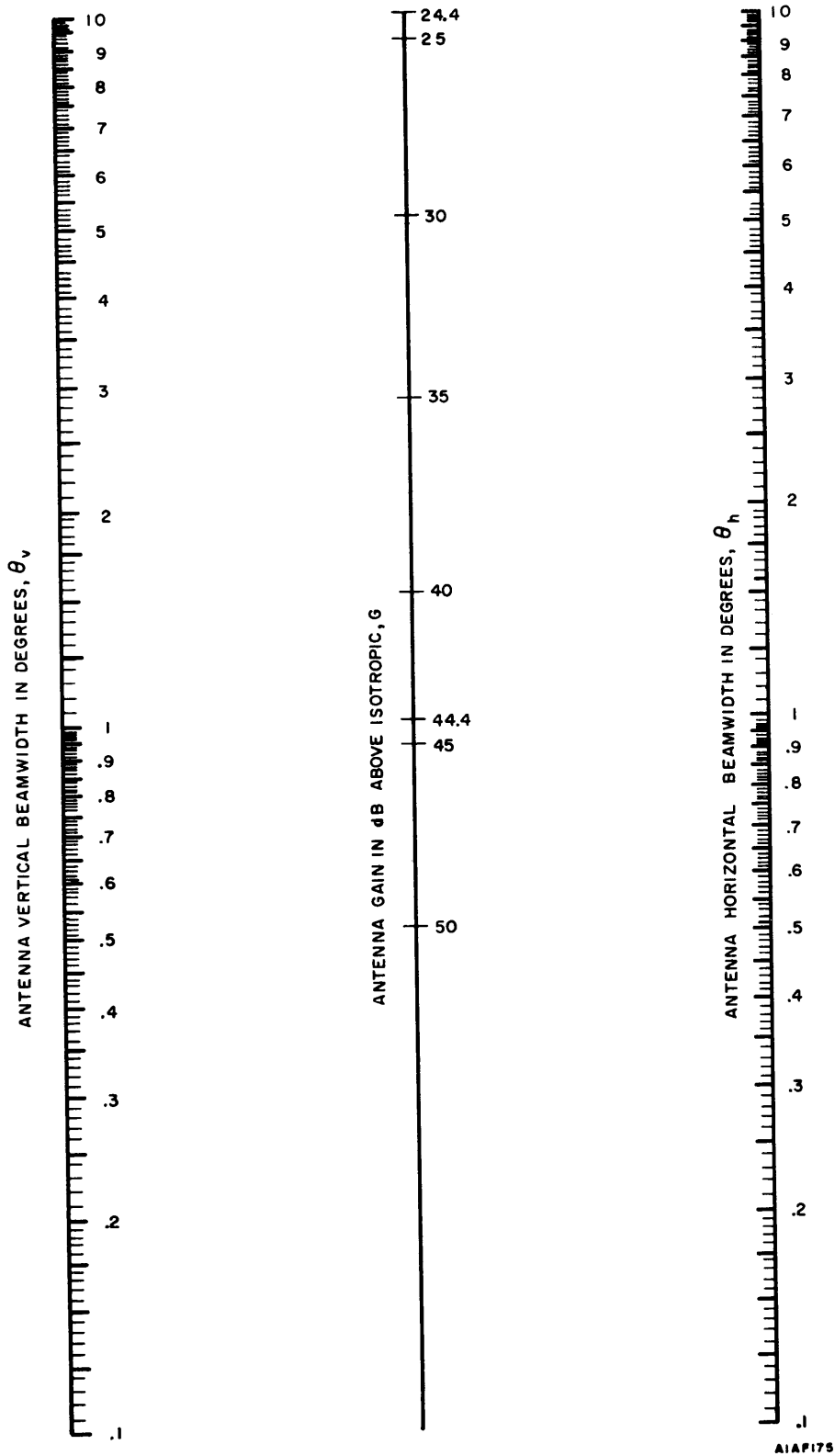

Figure 6 - 16. Nomogram for Determining Antenna Gain

Equation (6-7) has been plotted in Figure 6-17 as a nomogram.

o LINE 1.3.1, LOSS DUE TO OFF-AXIS POINTING AT RX

The case of two horizon scanning radar antennas is solved for the most pessimistic EMI situation, viz, the two antennas "looking at" each other or otherwise representing the angle of closest approach. If vertical misalignment of antenna exit or entry angle exists with the boresight axis and this value is greater than the one-half vertical beamwidth, obtain the correction from vertical pattern data. Consider the gain of either antenna to be 0 dB in any situation other than within a wedged sector representing twice the horizontal and vertical beamwidth, unless empirical data are otherwise available.

A somewhat different approach is required for the case of fixed antenna (non-scanning type) installations such as at microwave relay links. Since the first calculations are based on the most pessimistic situation, the orientation of a scanning radar antenna is chosen to give the minimum off-axis orientation with respect to the fixed antenna. The loss due to both horizontal and vertical off-axis pointing of the fixed antenna installation is obtained from published antenna polar plots or by assuming the loss from tables of nominal directional gain for different antenna types. If this is not available, then the gain corrections must be obtained by other methods, including choosing a known standard antenna type most closely resembling the one in question. The following discussion presents the methods for correcting for both horizontal and vertical off-axis antenna beam pointing.

o OFF-AXIS HORIZONTAL ANTENNA GAIN CORRECTION

While it is recommended that horizontal polar plot data corresponding to the specific antenna being analyzed be used, such data are not always available. For high gain antennas ( $G \geq 10$  dB) Figure 6-18 can be used to obtain an approximate correction for horizontal off-axis situations.

Since the completion of data of Figure 6-1 is based on the most pessimistic EMI situation, it is assumed that a scanning antenna is horizontally aligned with the other C-E equipment (emphasis on search and height finder radars) unless this situation cannot possibly prevail (e.g. tracking radar or telemetry). If the latter applies, the entry in the abscissa of Figure 6-18 is made at the off-axis angle in degrees corresponding to the number of horizontal beamwidths. The ordinate of Figure 6-18 thus corresponds to the resulting horizontal gain correction. If the off-axis angle is significant (e.g.,  $> 5$  beamwidths) the horizontal gain correction is such that the resulting antenna gain should not be less than -10 dB. In any event, the gain correction should not be such that an over-all antenna gain of less than -10 dB with reference to an isotropic radiator is realized. This value corresponds to a typical scatter level gain for scanning type antennas.

Where antennas used in microwave relay links are involved, specific horizontal polar plot data are usually available and should be used for off-axis horizontal gain corrections. For those situations where a substantial horizontal off-axis antenna pointing situation may exist, it is possible that the directional gain may be less than -10 dB. A lower limit of -25 dB above isotropic is assumed to apply.

o OFF-AXIS VERTICAL ANTENNA GAIN CORRECTION

The correction required for a vertical angle antenna beam misalignment between the transmitting and receiving pair involves calculations similar to that for horizontal, plus other considerations: corrections for the vertical angle displacement between antenna electrical pointing axis and tangent to the earth; corrections for separation distance between antennas resulting in corrections due to curvature of the earth; and corrections for difference in antenna elevations above mean sea level (MSL). These additional corrections result in an over-all vertical entry or exit angle correction that must be made for high gain antennas whose beams are not pointing at each other. The following discussion amplifies these considerations.

The vertical entry or exit angle  $\Phi$  between the antenna axis and the arriving or departing wave, may be computed with reference to Figures 6-19 and 6-20.

$$\Phi = \alpha + \beta + \gamma \quad (6-8)$$

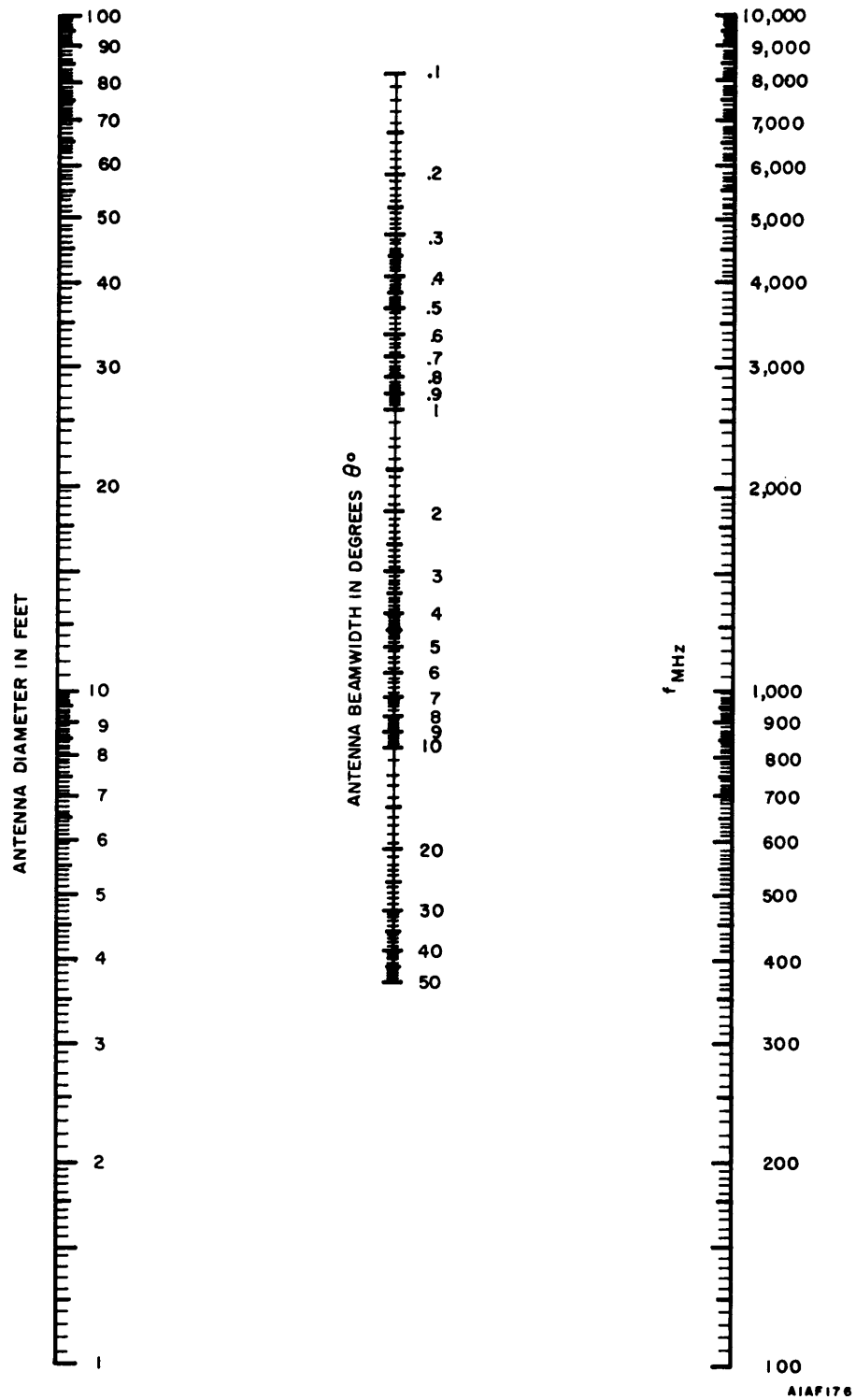

Figure 6 - 17. Nomogram for Determining Antenna Beamwidth

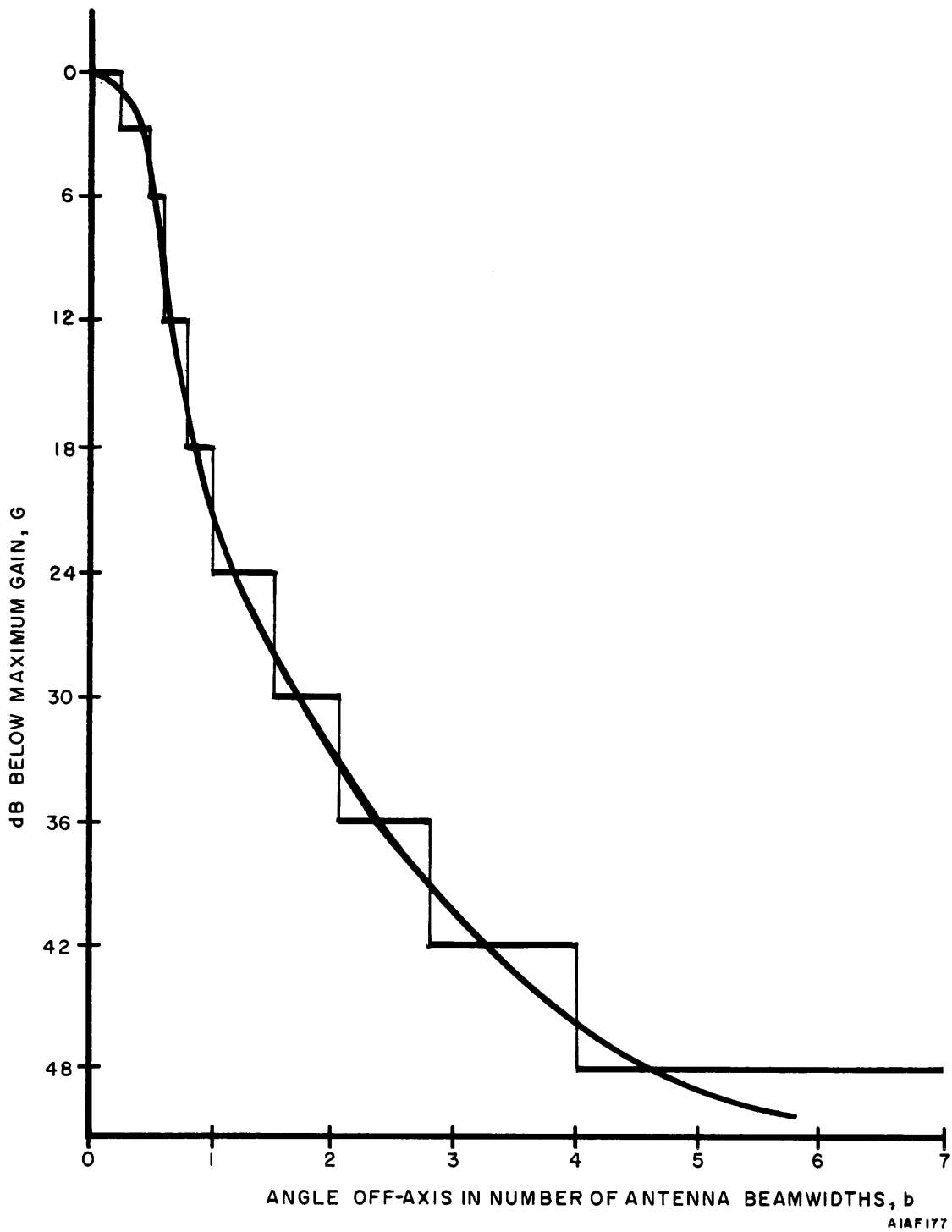

Figure 6 - 18. Envelope and Quantization of Typical High Gain Antenna Pattern

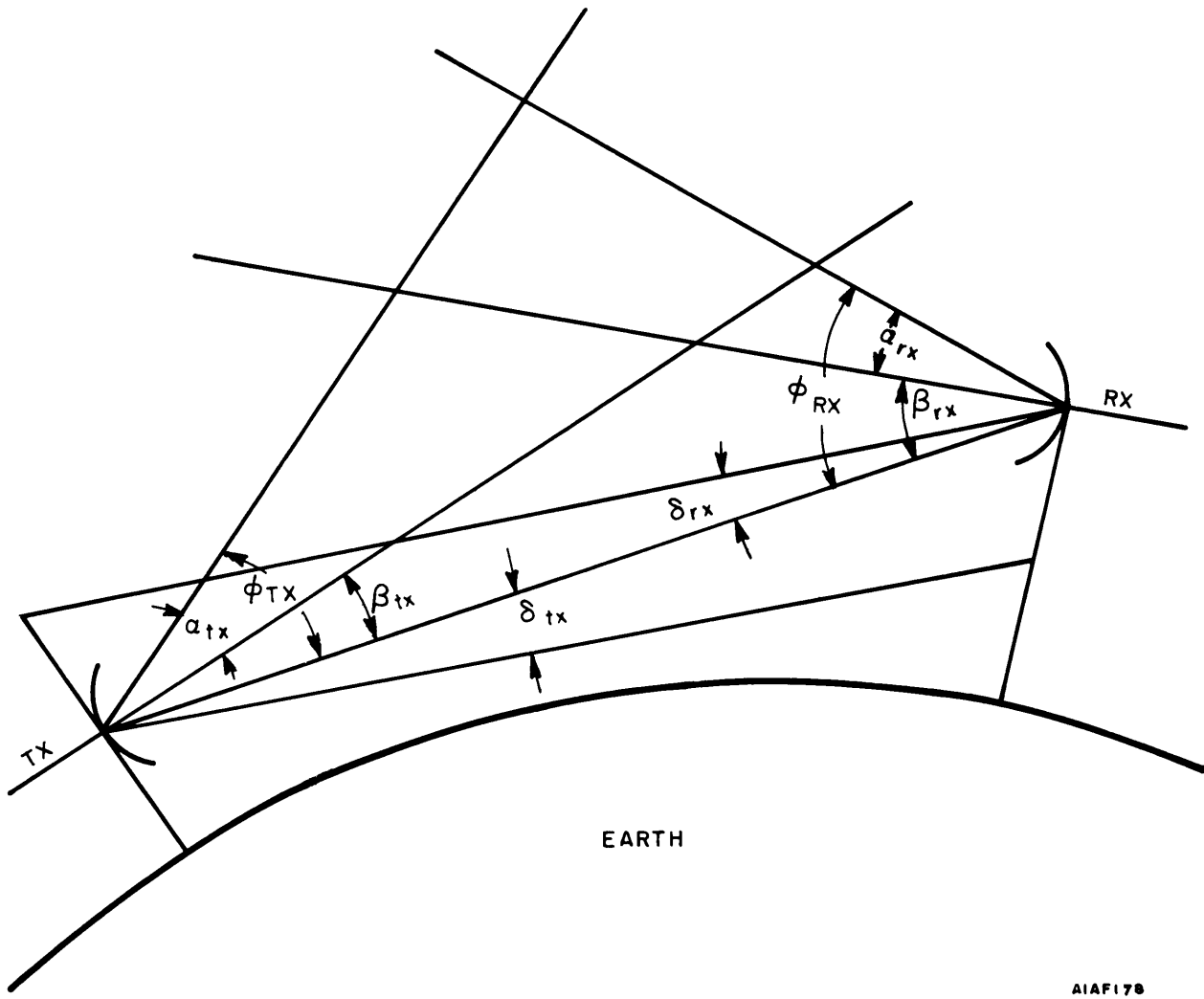

Figure 6 - 19. Exit and Entry Elevation Angle Situation Between TX-RX Pairs



where:

$\alpha$  = elevation angle between antenna axis and the tangent to the earth

$\beta$  = elevation angle due to curvature of the earth

$\gamma$  = elevation angle due to difference between TX-RX antenna elevations above MSL.

In terms of each of the above separate elevation angles,  $\Phi$  may be computed for either TX or RX.

$$\Phi_{TX} = \alpha_{TX} + 0.0073R_{mi} - 0.0109(h_{RX} - h_{TX})/R_{mi} \text{ degrees} \quad (6-9)$$

$$\Phi_{RX} = \alpha_{RX} + 0.0073R_{mi} + 0.0109(h_{RX} - h_{TX})/R_{mi} \text{ degrees} \quad (6-10)$$

where:

$\Phi$  = the total off-axis vertical entry or exit angle in degrees

$R_{mi}$  is the TX-RX distance (in statute miles)

$h_{RX}$  is the height (in feet) above MSL of the RX antenna

$h_{TX}$  is the height (in feet) above MSL of the TX antenna

Figure 6-19 depicts the details of the individual elevation angle corrections defined in equations 6-9 and 6-10. The third term of these equations is an approximation since the heights of the antennas are foreshortened by the cosine of the earth curvature (see figure 6-20). For distances corresponding to angles less than about ten degrees (TX-RX separation of 800 miles), the error is negligible.

The  $\alpha$  and the  $\gamma$  terms are the prime contributors to antenna off-axis entry or exit angles. The  $\alpha$  term must be determined at the site. The  $\gamma$  term becomes large if both the difference between the TX and RX antennas' height above MSL is large and the physical separation is small.

After computing the total off-axis vertical entry or exit angle in degrees, it remains to determine the resulting antenna gain correction. As used for horizontal gain correction, known vertical pattern data must be used. If this is not available, see figure 6-18 for high gain antennas. If the vertical pattern is of cosecant<sup>2</sup>  $\Theta$  type (e.g. many search radar antennas) figure 6-21 may be used. Where microwave relay links and high gain antennas other than those used for radar are involved, the vertical antenna gain corrections shown in table 6-6 may be used.

#### o LINE 1.3.2, LOSS DUE TO NEAR FIELD EFFECT

When either the transmitting or receiving antenna is in the Fresnel region of the other, an antenna gain correction factor must be applied to the far field in order to present a realistic situation. No correction is required, however, for low gain antennas (less than 10 dB). In order to determine the exact boundary between the Fresnel region and the far-field, equation 6-11 may be used. If it is necessary to determine whether a Fresnel situation exists, or not, figure 6-22 should be consulted.

$$d_{min} = \frac{L^2 f_{MHz}}{984} \quad (6-11)$$

Table 6-6. Typical Quantized Vertical Antenna Gain Used in Microwave Relay Links

VERTICAL OFF-AXIS ENTRY ANGLE	GAIN
$-B_v/2 \leq \phi_v \leq B_v/2$	$G_{RX}$
$-B_v/2 \leq \phi_v < -B_v/2$ $B_v/2 < \phi_v \leq B_v$	$G_{RX} - 10 \text{ dB}$
$-2B_v \leq \phi_v < -B_v$ $B_v < \phi_v \leq 2B_v$	$G_{RX} - 25 \text{ dB}$
Other entry angles	$G_{RX} - 60 \text{ dB}$
where: $\phi_v$ = interference signal entry angle $B_v$ = vertical 3 dB beamwidth $G_{RX}$ = receiver antenna gain in dB	

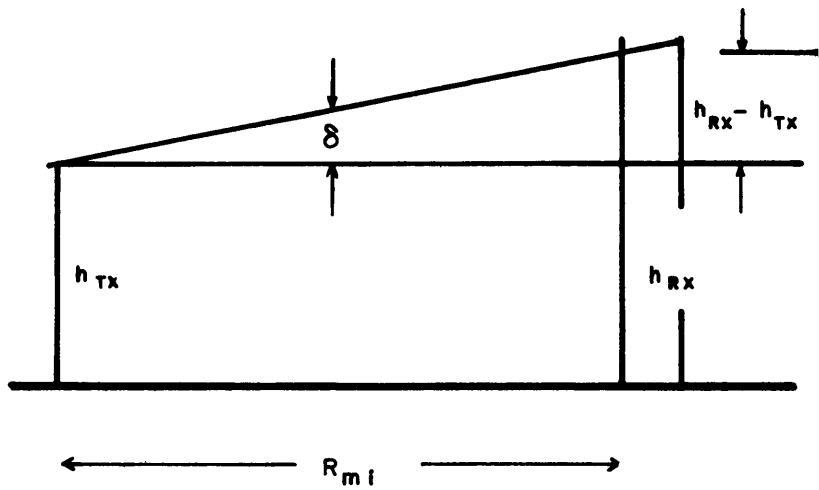

$$\begin{aligned} \tan \delta &= \frac{(h_{RX} - h_{TX})}{5280 R_{mi}} \\ \delta &= \frac{57.3 (h_{RX} - h_{TX})}{5280 R_{mi}} \\ &= 0.0109 (h_{RX} - h_{TX}) / R_{mi} \text{ DEGREES} \end{aligned}$$

AIAF 179

Figure 6 - 20. Correction per Difference in TX-RX Antenna Elevation Above MSL

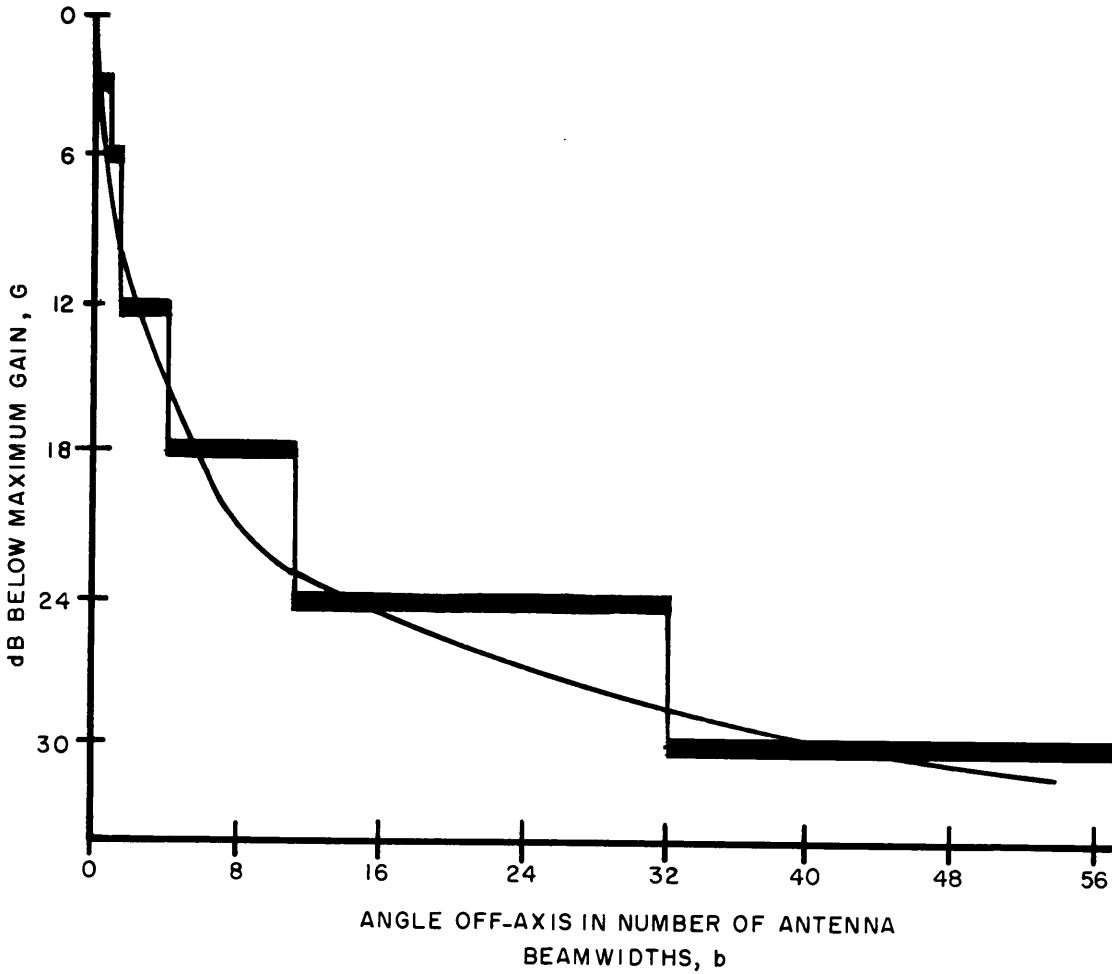

AIAF 180

Figure 6 - 21. Envelope and Quantization of Cosecant Squared Antenna Pattern

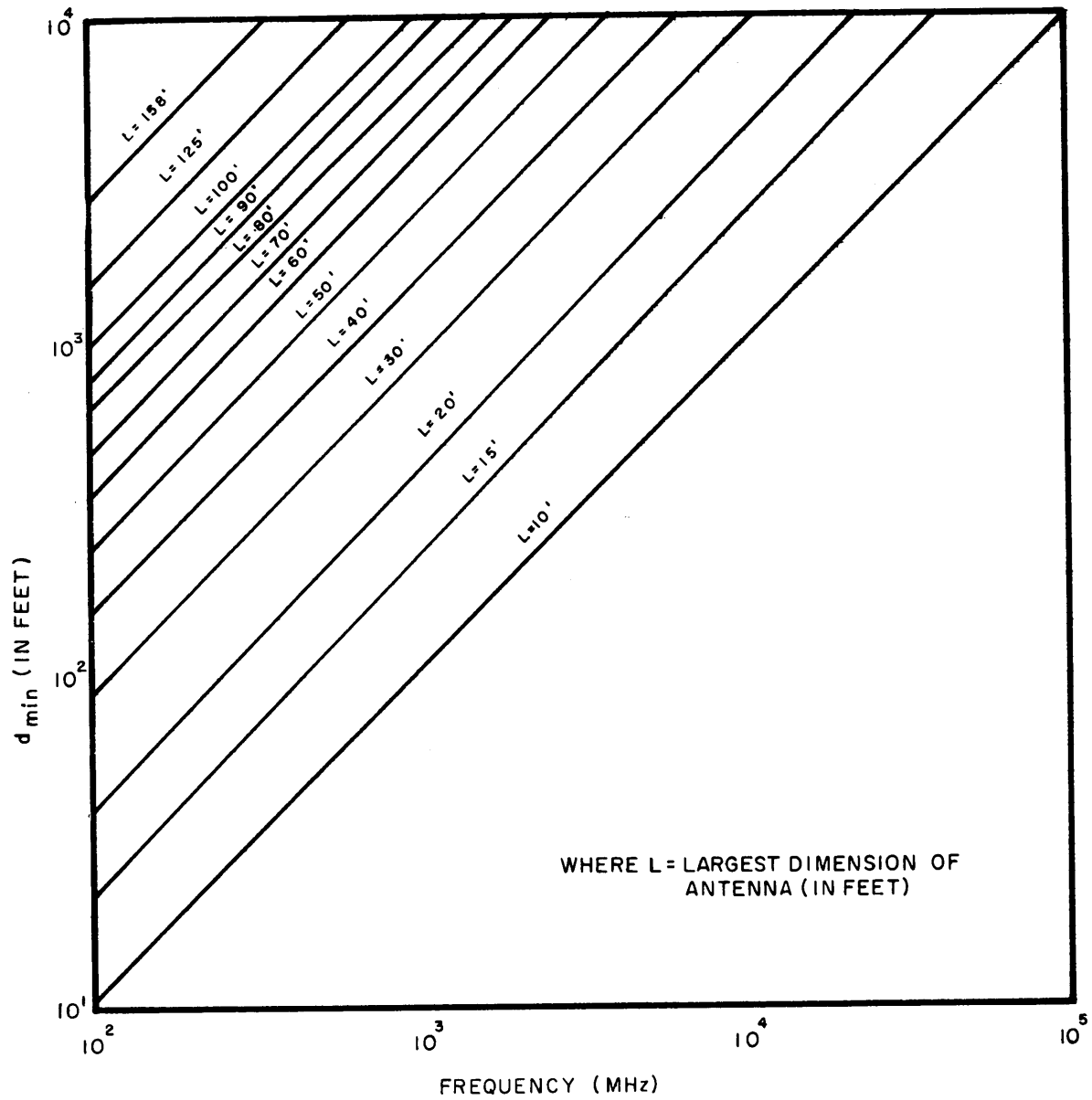

Figure 6 - 22. Minimum Distance Required for Fresnel Region Correction

where:

L is the largest dimension (diagonal) of the antenna in ft. and  $= \sqrt{h^2 + v^2}$

h = horizontal dimension of antenna aperture in ft.

v = vertical dimension of antenna aperture in ft.

f = operating frequency in MHz

If the actual TX-RX separation is greater than the value obtained from equation (6-11) or figure 6-22, then no correction is required. If, however, the TX-RX separation is less than the Fresnel Region boundary, a correction must be applied for either the transmitter, receiver, or both antenna gains. The first step in the evaluation of the correction factor ( $C_{FR}$ ) is to compute values of x and y in the following equation.

$$x = \frac{h(ft) \sqrt{f_{MHz}}}{44.4 \sqrt{d_{ft}}} \tag{6-12}$$

$$y = \frac{v(ft) \sqrt{f_{MHz}}}{44.4 \sqrt{d_{ft}}} \tag{6-13}$$

where:

d = distance between TX-RX (in feet)

After values of x and y are obtained, correction factors  $C_x$  and  $C_y$  are then determined from figure 6-23 if the antenna illumination is known. Unfortunately, the aperture illumination is unknown for many antennas, however, an estimate of the aperture illumination can be made by computing R in equation (6-14) or equation (6-15) and using this value with table 6-7.

Table 6-7. Estimate of Illumination

VALUE OF R	ESTIMATED ILLUMINATION
$0.88 \leq R < 1.2$	Uniform
$1.2 \leq R < 1.45$	Cosine
$1.45 \leq R < 1.66$	Cosine <sup>2</sup>
$1.66 \leq R < 1.93$	Cosine <sup>3</sup>
$1.93 \leq R < 2.03$	Cosine <sup>4</sup>

$$R = \frac{\pi}{180} \frac{\Theta_H H}{\lambda} \quad (6-14)$$

where:

$\Theta_H$  = horizontal antenna beamwidth at the half power point (in degrees)

$\lambda$  = wavelength (feet)

H = antenna horizontal dimension (feet)

or

$$R = \frac{\pi}{180} \frac{\Theta_V V}{\lambda} \quad (6-15)$$

where:

$\Theta_V$  = vertical antenna beamwidth at the half power points (in degrees)

V = antenna vertical dimension (feet)

Using the estimated illumination and previously computed values of x or y, Figure 6-23 may now be used to obtain  $C_x$  or  $C_y$ . The Fresnel region correction factor ( $C_{FR}$ ) is simply the sum  $C_x$  and  $C_y$  and is entered in line 1.3.2.

o LINE 1.4, SUBTOTAL LINE 1.1.1 THROUGH 1.3.2, COLUMN A

This entry is the sum of entries 1.1.1 through 1.3.2 existing in Column A

o LINE 1.5, SUBTOTAL LINE 1.1.1 THROUGH 1.3.2 COLUMN B

This entry is the sum of entries 1.1.1 through 1.3.2 existing in Column B

o LINE 1.6, TOTAL LINE 1.4 - LINE 1.5 - EFFECTIVE RADIATED POWER (ERP)

This entry represents the effective radiated power of the TX (in dBm) and is obtained by subtracting the absolute value of line 1.5 from line 1.4. If possible, the quantity should be measured at the TX and inserted in Line 1.6.

### 6.5.2 Propagation

The space surrounding a transmitting antenna may be divided into several regions whose boundaries cannot be clearly defined. The Fresnel region lies adjacent to the antenna and extends to a distance of  $2L^2/\lambda$  where L is the largest linear dimension of the antenna (or the diameter, D, for a round antenna) and is measured in the same units as  $\lambda$ .

The far field begins at the boundary of the Fresnel region. The first field to be encountered is the reflection field, so named because part of the energy existing at a receiver in this region is reflected from the earth. The geometry is shown in figure 6-24. This field extends to a distance equal to the sum of the transmitting antenna radio horizon and receiving antenna radio horizon, i.e., to a distance d, in miles given by:

$$d \approx \sqrt{2h_1} + \sqrt{2h_2} \quad (6-16)$$

where:

$h_1$  and  $h_2$  are measured in feet.

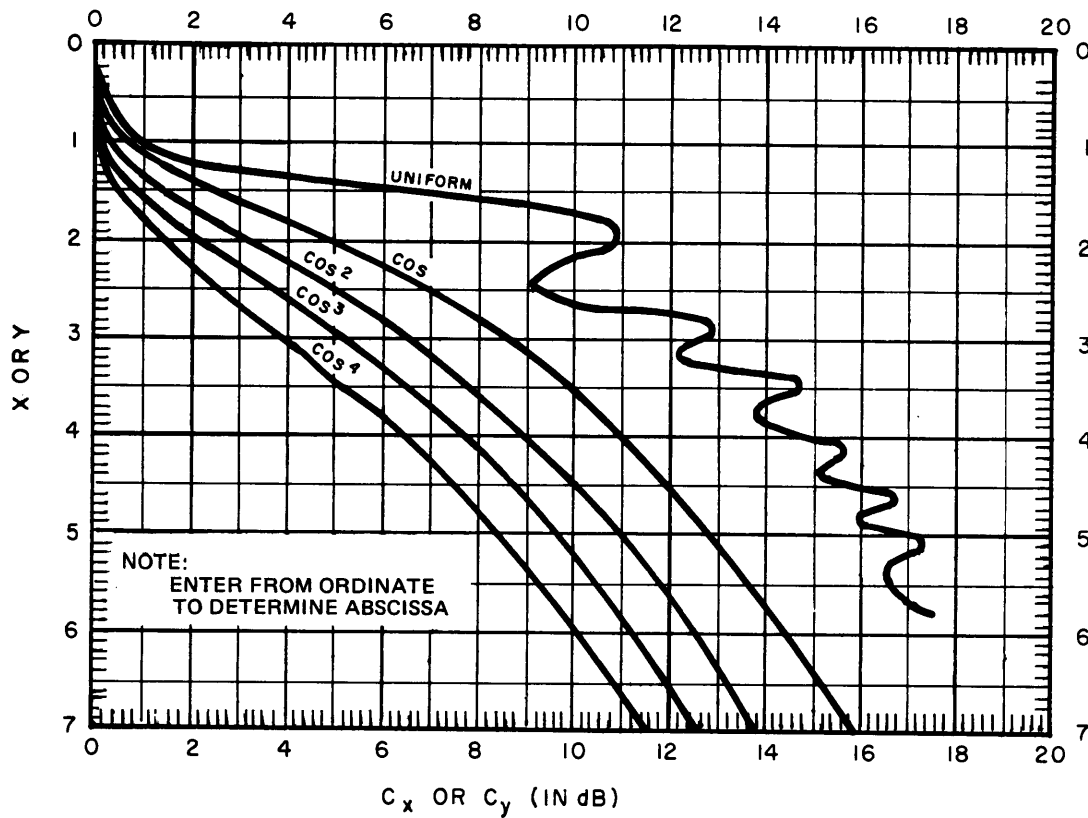

AIAF 182

Figure 6 - 23. Fresnel Region Antenna Gain Correction Curves for Various Illuminations

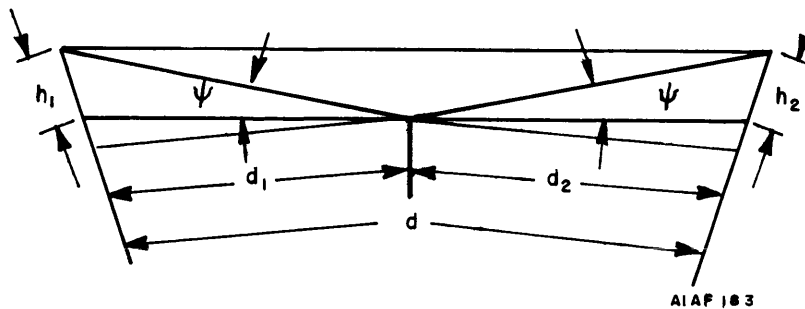

AIAF 183

Figure 6 - 24. Geometry of Reflection Field (Line-of-Sight Propagation)

In the region immediately beyond the boundary of the reflection region the propagation effects change, but in view of the small area of a shore station it is very doubtful that any of the transmitter-receiver paths will extend beyond the reflection field. In the few cases where they do, the calculations for the reflection region will give a good approximation provided the range is not more than 5 or 10 percent greater than that calculated in the above equation.

o LINE 2.1, CONSTANT

This is a dimensional constant which must be included when totaling the entries of Section 2, Propagation.

o LINE 2.2, WAVE SPREADING TX-RX DISTANCE:  $- 20 \log R_{mi}$

The basic prediction equation includes the well known free space loss calculation between two isotropic gain antennas. The expression for this calculation is generally given in handbooks in the following form:

$$L_{fs} = 37 \text{ dB} + 20 \log d_{mi} + 20 \log f_{\text{MHz}} \quad (6-17)$$

where:

- $L_{fs}$  = the free space loss in decibels.
- $f_{\text{MHz}}$  = the transmitted frequency in megahertz.
- $d_{mi}$  = the transmitter-receiver separation distance in statute miles.

o Entry 2.2 WAVE SPREADING -  $20 \log R_{mi}$  is equivalent to the  $20 \log d_{mi}$  expression in the above equation. The expression,  $20 \log f_{\text{MHz}}$  in the above equation is included in the ENTRY 3.2.2, RX FREQUENCY  $-20 \log f_{\text{MHz}}$ , of the EMI PREDICTION CALCULATION form. The 37 dB constant is distributed between ENTRY 2.1 and the ENTRY 3.2.1 constant.

To perform a prediction using free space propagation losses, it is only necessary to enter figure 6-25 at the distance corresponding to the transmitter-receiver separation and read the numerical value on the ordinate, which is the value in dB corresponding to  $20 \log R_{mi}$ . This value is then entered in the prediction calculation form (in ENTRY 2.2). If only the effects of free space loss were to be considered, then ENTRIES 2.1 and 2.2 would be subtotaled in ENTRIES 2.6 and 2.7 and then totaled in ENTRY 2.8. The value of ENTRY 2.8 represents the propagation loss for the initial conditions specified at the top of the prediction form. When the value in ENTRY 2.8 is added to the value in ENTRY 1.6 (as is indicated in ENTRY 2.9), the total represents the power density existing at the RX antenna in  $\text{dBm/m}^2/\text{MHz}$ .

It can be seen from the foregoing discussion, and the development of the prediction equations given earlier that a complete prediction can be made using only entries 2.1, 2.2, 2.6, 2.7, 2.8 and 2.9, of the EMI PREDICTION FORM. However, this free space loss more often represents a minimum loss value and, consequently, higher interference levels will be predicted than will actually exist. Therefore, it is necessary to consider the additional effects which are associated with reflected, diffracted, and scatter modes of propagation. The more detailed analyses are especially important when a marginal case of interference is predicted using the free space loss effects only.

o LINE 2.3, REFLECTION FIELD

Whenever an electromagnetic wave is propagated through space and strikes a reflecting surface, such as the surface of the earth, it is changed in both magnitude and phase. The form to be used for performing reflection field propagation calculations is shown on figure 6-26.

The reflection field propagation loss calculations are a function of the transmitter/receiver: antenna height; polarization; separation; and reflecting surfaces coefficient of reflection. Each of these parameters are functions of the other variables shown in figure 6-26. The value to be calculated and entered in the EMI prediction form is the reflection field propagation loss in excess of free space losses (i.e., propagation losses entry 2.1) will always



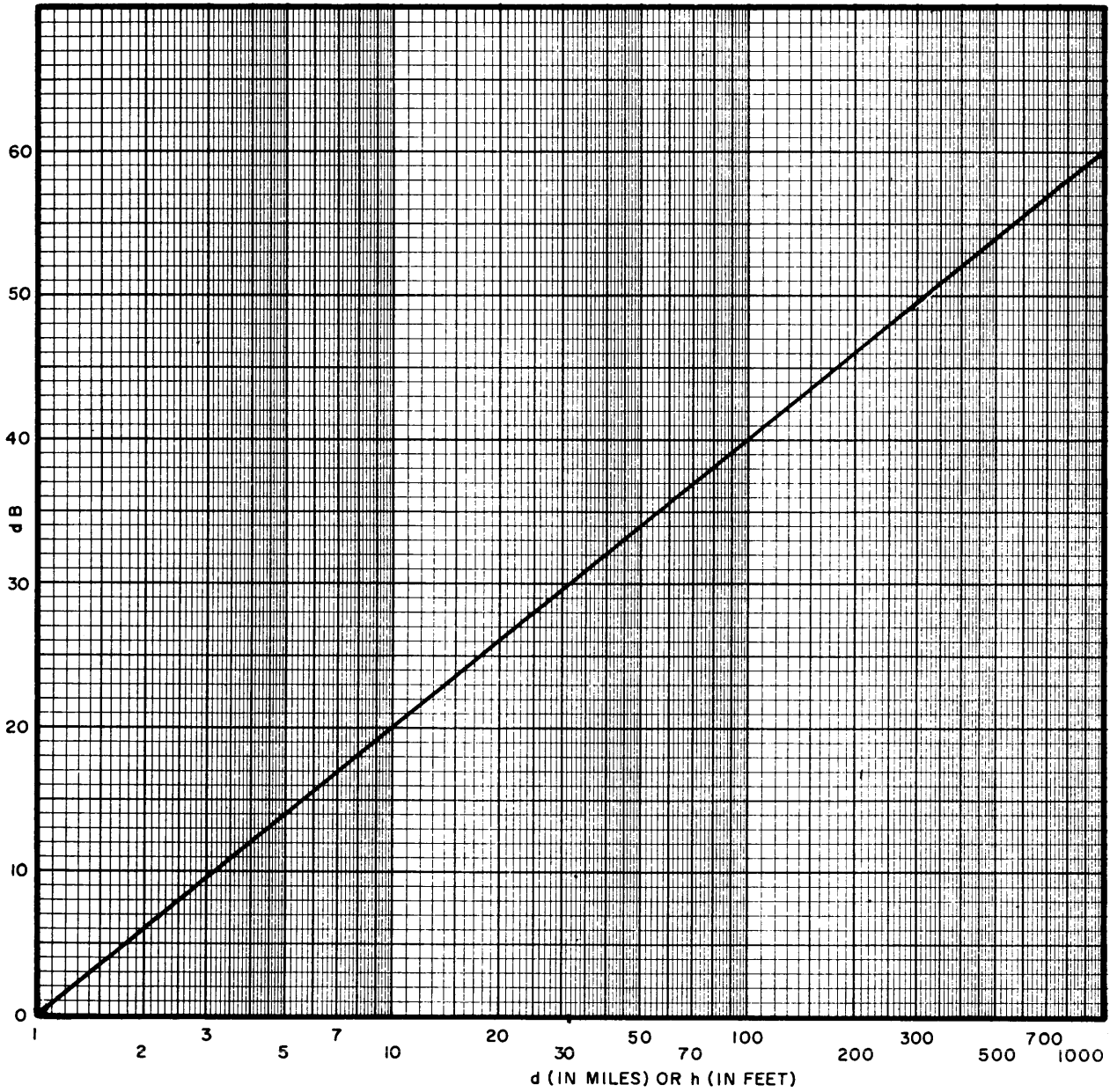

AIAF 184

Figure 6 - 25. Convenience Factor 20 Log N

**NAVELEX 0101,106**

Transmitter (TX) \_\_\_\_\_ Receiver (RX) \_\_\_\_\_  
 Transmitter Site \_\_\_\_\_ Receiver Site \_\_\_\_\_  
 TX Antenna Height (h) \_\_\_\_\_ RX Antenna Height (h) \_\_\_\_\_ ft.  
 TX Antenna Polarization \_\_\_\_\_ Separation Between TX & RX (d) \_\_\_\_\_ mi.  
 Frequency of Interference \_\_\_\_\_ MHz  $\sigma =$  \_\_\_\_\_  $\epsilon =$  \_\_\_\_\_

**1. CALCULATION OF DIVERGENCE FACTOR D**

**1.1 Calculate Distance to Reflecting Fresnel Area  $d_1$  (c, m, b)**

1.1.1 Calculate  $c = \frac{h_1 - h_2}{h_1 + h_2}$  c =

1.1.2 Calculate  $m = \frac{d^2 \text{ mi}}{4(h_1 + h_2)}$  m =

1.1.3 Obtain "b" from Figure 6-27 (Use values of lines 1.1.1 and 1.1.2) b =

1.1.4 Calculate  $d_1 = \frac{d}{2} (1+b)$  (Use line 1.1.3)  $d_1 =$

1.1.5 Calculate  $d_2 = d - d_1$  (Use line 1.1.4)  $d_2 =$

**1.2 Determine Tangent of Grazing Angle  $\psi$  (tan  $\psi$ )**

1.2.1 Enter  $h_1$  in Figure 6-28

1.2.2 Enter  $d_1$  (from line 1.1.4) in Figure 6-28

1.2.3 Read tan  $\psi$  from Figure 6-28 tan  $\psi =$

**1.3 Determine  $\delta = d_1 d_2 / d$  (Use lines 1.1.4, 1.1.5, and d in Figure 6-29)**  $\delta =$

**1.4 Divergence Factor D from Figure 6-30 (Use value of lines 1.2.3 and 1.3)** D =

**2. CALCULATION OF REFLECTION COEFFICIENT**

**2.1 Vertical Polarization Reflection Coefficient**

2.1.1 Calculate x term of  $\bar{n}^2 = \epsilon_r - jx$  where  $x = 18000 \sigma / f_{\text{MHz}}$  x =

2.1.2 Obtain  $R_{90}$  Figure 6-31 (Use line 2.1.1)  $R_{90} =$

2.1.3 Obtain Sin  $\psi_{90}$  Figure 6-31 (Use line 2.1.1) Sin  $\psi_{90} =$

2.1.4 Calculate  $\rho = \frac{\text{Sin } \psi}{\text{Sin } \psi_{90}}$   $\rho =$

2.1.5 Obtain R Figure 6-32 (Use line 2.1.4) R =

2.1.6 Obtain  $\varphi$  Figure 6-33 (Use line 2.1.4)  $\varphi =$

**3. CALCULATION OF REFLECTED FIELD LOSS**

3.1 Calculate (D) (R) product (lines 1.4 and 2.1.5) DR =

3.2 Calculate Path Length Difference  $\theta$

3.2.1 Using the data from Lines 1.2.3 and 1.3 and A. in Figure FO-1 read  $\theta / f_{\text{MHz}}$   $\theta / f_{\text{MHz}} =$

3.2.2 Calculate  $\theta = \theta / f_{\text{MHz}} (f_{\text{MHz}})$   $\theta =$

3.3 Calculate ( $\theta - \varphi$ ) total phase difference between reflected and direct difference (line 3.2.2 and line 2.1.6)  $\theta - \varphi =$

3.4 Obtain  $g(\theta)$  from B. in Figure FO-1 (Use lines 3.1 and 3.3)  $g(\theta) =$

3.5 Calculate Loss "A" in excess of Free Space Loss  $-20 \log g(\theta) + 2.15 \text{ dB}$  A =

AIAF246

Figure 6 - 26. Reflection Field Propagation Loss Calculation

be calculated. Losses calculated due to other propagation modes will include only those losses in excess of free space loss.

The first step to determine the reflected field strength at a point in space requires the solution of the reflection geometry involved. The geometrical considerations are shown in figure 6-24. The transmitter height,  $h_1$ , receiver location height,  $h_2$ , both above smooth earth, and great circle distance between the two locations are specified or obtained from a map or similar source.

The second step in determining the reflection field losses is the calculation of the reflection coefficient of the reflecting surface. The reflection coefficient  $\bar{R}$  provides a measure of the change of magnitude and phase of a reflected electromagnetic wave. The reflection coefficient  $\bar{R}$  is a function of the carrier frequency  $f_{\text{MHz}}$ , the relative permittivity of the reflecting surface [ $\epsilon_r$ ], the conductivity of the reflecting surface ( $\sigma$ ), the grazing angle of incident ray on the reflecting surface ( $\psi$ ) and polarization of carrier signal (h or v). The parametric relationships can be seen in the following equations:

$$\bar{R}_v = \frac{\bar{n}^2 \sin \psi - (\bar{n}^2 - \cos^2 \psi)^{1/2}}{\bar{n}^2 \sin \psi + (\bar{n}^2 - \cos^2 \psi)^{1/2}} \quad (6-18)$$

where:

$\bar{R}_v$  = Reflection coefficient for vertically polarized signal.

$$\bar{n}^2 = \epsilon_r - j 18000\sigma/f_{\text{MHz}} \quad (6-19)$$

$$\bar{R}_h = \frac{\sin \psi - (\bar{n}^2 - \cos^2 \psi)^{1/2}}{\sin \psi + (\bar{n}^2 - \cos^2 \psi)^{1/2}} \quad (6-20)$$

where:

$\bar{R}_h$  = Reflection coefficient for horizontally polarized signal.

The third step is to combine the effects of steps 1 and 2 to obtain a value which represents a loss in excess of free space losses due to reflection field propagation. The following illustrative example is presented to demonstrate the application of the reflection field computation technique and associated figures. Assume the following conditions exist:

- o TX antenna height - 580 feet
- o RX antenna height - 30 feet
- o TX antenna polarization - Vertical
- o TX-RX separation - 25 miles
- o Frequency of interference - 6000 MHz

The above data is entered at the top of the Reflection Field Propagation Loss Calculation shown in figure 6-26. Section 1 of this figure encompasses the calculation of the divergence factor D. The divergence factor is a function of the transmitter/receiver geometry shown in figure 6-24.

Section 1.1 is used to calculate the distance  $d_1$  (ref. figure 6-24) to the reflecting Fresnel Area. The determination of the distance  $d_1$  is made using the following relationships.

$$d_1 = \frac{d}{2}(1+b) \text{ where } b = \frac{d_1 - d_2}{d_1 + d_2} \quad (6-21)$$

$$h_1 = \frac{h_1 + h_2}{2}(1+c) \text{ where } c = \frac{h_1 - h_2}{h_1 + h_2} \quad (6-22)$$

$$c = b + \frac{bd^2(1-b^2)}{4(h_1 + h_2)} \text{ for } K = 4/3 \quad (6-23)$$

$$c = bm(1-b^2) \text{ where } m = \frac{d^2}{4(h_1 + h_2) \text{ ft}} \quad (6-24)$$

Lines 1.1.1 and 1.1.2 are straightforward arithmetic computations to be performed as indicated.

$$\text{o Line 1.1.1 } c = \frac{h_1 - h_2}{h_1 + h_2} = \frac{580 - 30}{580 + 30}$$

$$\text{o Line 1.1.2 } m = \frac{d_{\text{mi}}^2}{4(h_1 + h_2)} = \frac{(25)^2}{4(580 + 30)} = 0.256$$

Using the values obtained from lines 1.1.1 and 1.1.2, and figure 6-27 determine the value of  $b$  and record this in line 1.1.3. Using the value of “ $b$ ” perform the arithmetic operations indicated in lines 1.1.4 and 1.1.5 to obtain “ $d_1$ .”

The tangent of the grazing angle ( $\psi$ ) is obtained in line 1.2.3 using the values of  $h_1$  and  $d_1$  in figure 6-28.

Line 1.3 is solved, using figure 6-29 and the values of  $d_1$ , and  $d_2$  and “ $d$ ” previously specified or calculated.

Line 1.4 is solved using the values of 1.2.3 and 1.3 in figure 6-30.

o LINE 2.1, VERTICAL POLARIZATION

Determine  $R_{90}$  (Line 2.1.2) and  $\sin \psi_{90}$  (Line 2.1.3) from figure 6-31 corresponding to the values of  $\sigma$  and  $\epsilon_1$  obtained from Table 6-8.

$$\text{Calculate } \rho = \frac{\sin \psi}{\sin \psi_{90}} \text{ (Line 2.1.4) where } \psi \text{ is the grazing angle under consideration.}$$

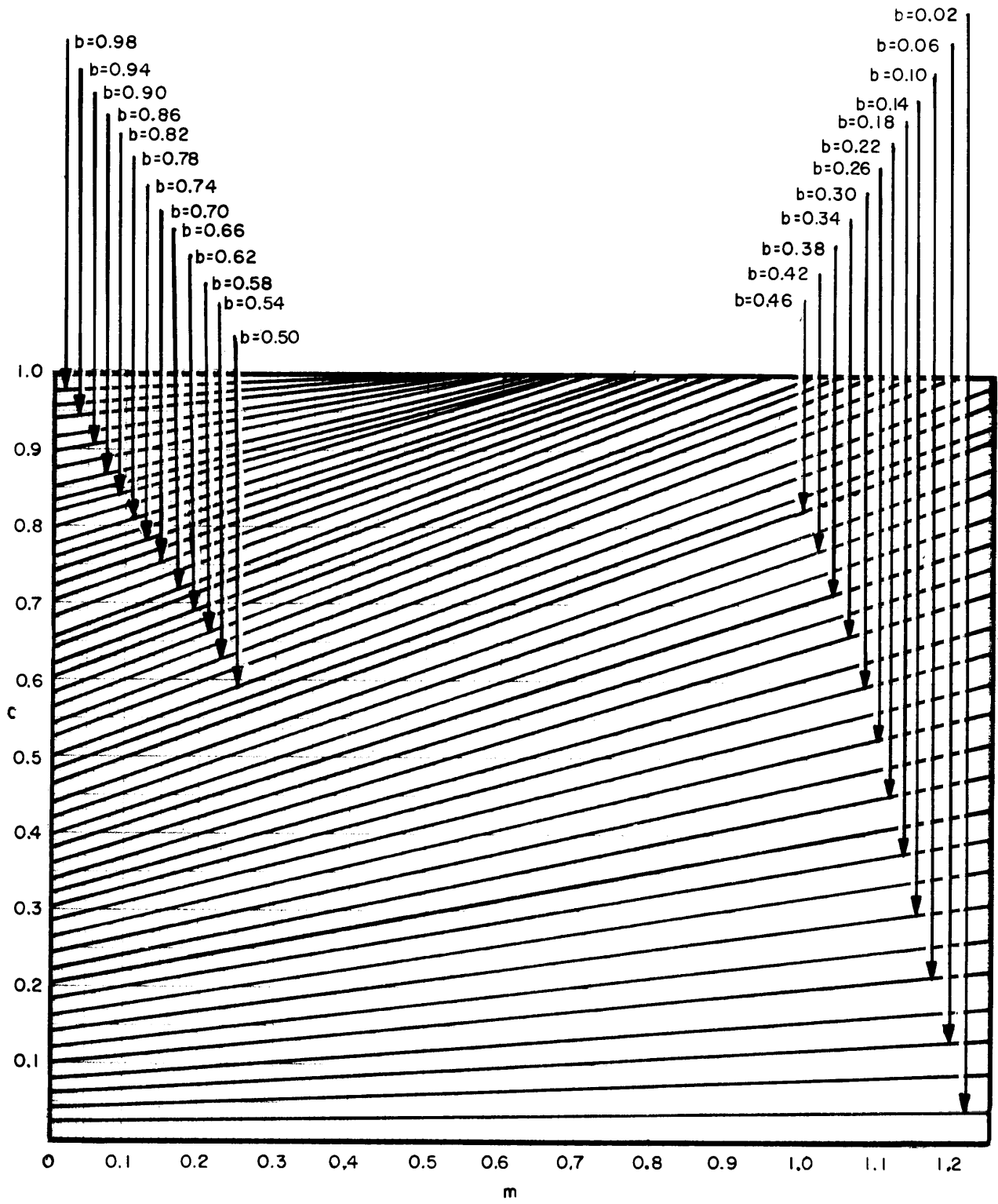

AIAF 185

Figure 6 - 27. Nomogram for Determining  $b$  From Cubic Equation ( 6-24 )

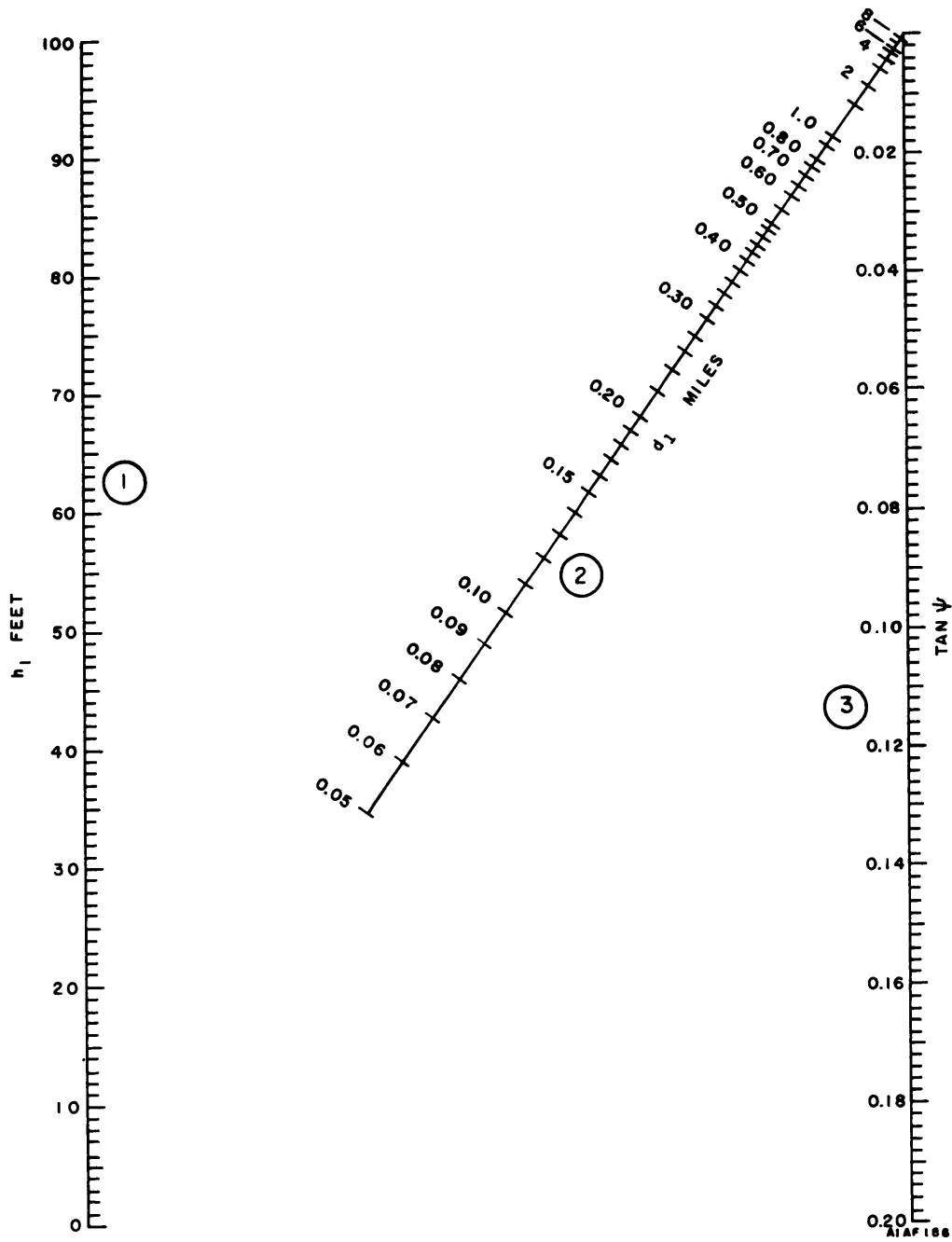

Figure 6 - 28. Nomogram for Determining Tan  $\psi$

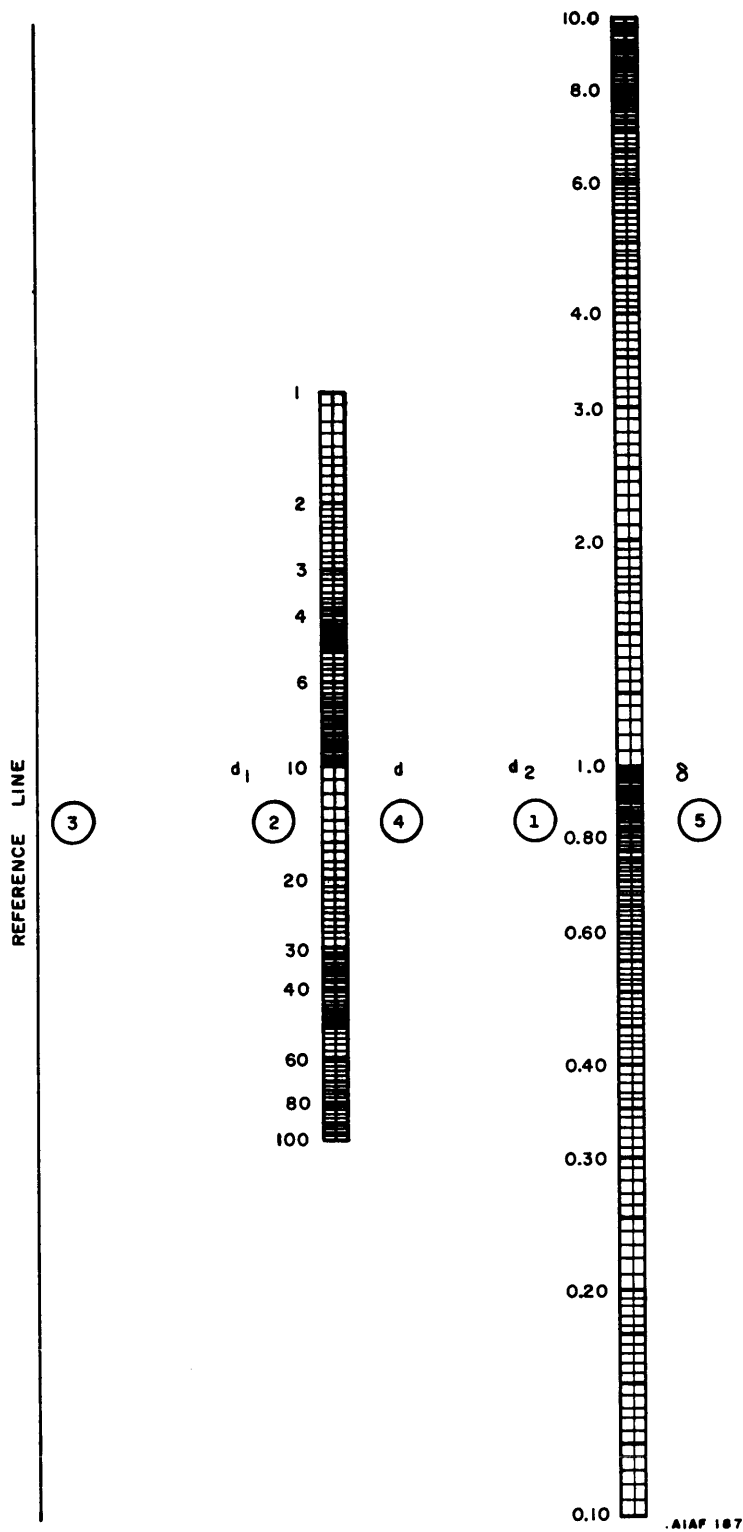

Figure 6 - 29. Nomogram for Determining  $\delta$

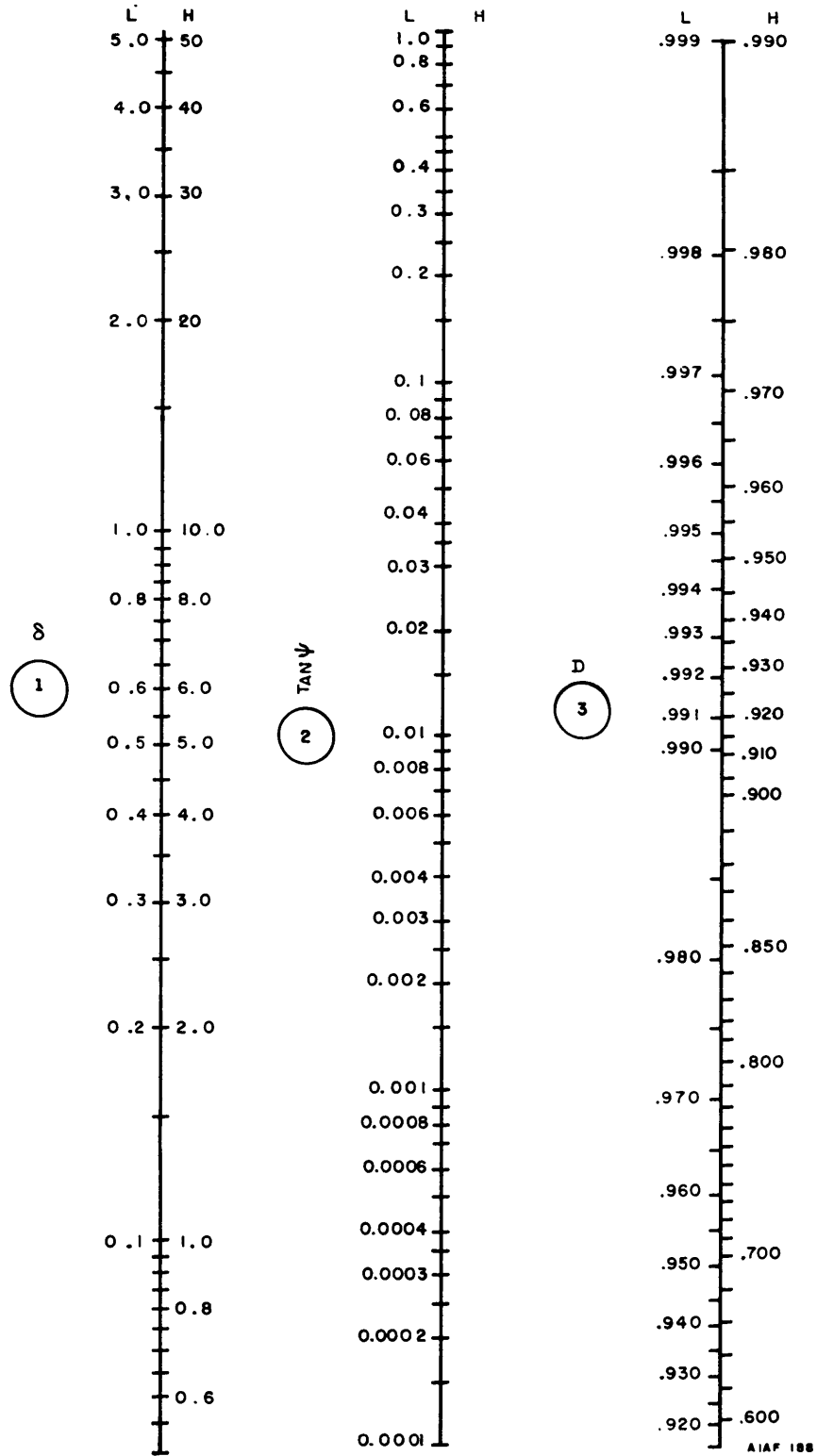

Figure 6 - 30. Nomogram for Determining D When K = 4/3



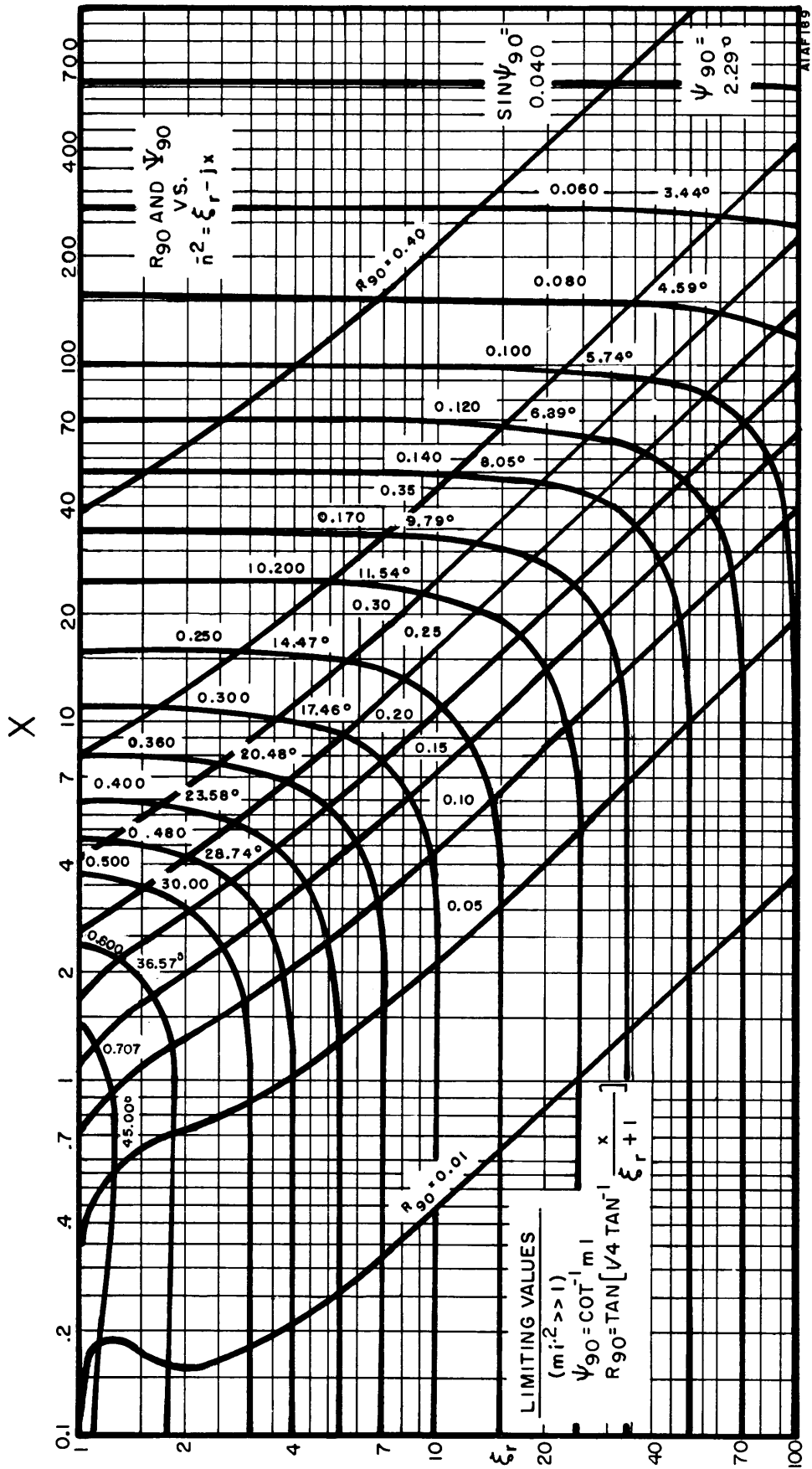

Figure 6 - 31. Limiting Values

Table 6-8. Representative Values of Permittivity and Conductivity for Various Reflecting Surfaces

TYPE OF SURFACE	PERMITTIVITY $\epsilon_r$	CONDUCTIVITY $\sigma$ mho-m/m <sup>2</sup>
Sea water	81	4.64 to 5.0
Fresh water	81	0.005
Tundra	5	0.0004
Glacial ice	3	0.000025
Arctic ice	3	0.0001 to 0.010
Marsh land	30	0.111
Average land	15	0.0278
Desert land	3	0.0111

From figure 6-32 corresponding to R and the calculated value of  $\rho$  determine the magnitude of the reflection coefficient. From figure 6-33 determine the phase of the reflection coefficient.

### 6.5.3 Receiver

The effects of the receiver upon the static EMI situation may be described by the following equation:

$$\text{Receiver contribution} = \frac{K G_r B_r}{L_p L_r f^2 N} \quad (6-25)$$

where:

K = the constant of proportionality

$G_r$  = the receiver antenna gain

$B_r$  = the receiver 3 dB bandwidth

$L_p$  = the polarization mismatch loss

$L_r$  = the receiver transmission line loss

f = the receiver frequency

N = the receiver internal noise power

The receiver portion of the prediction sheet presents the receiver parameters given above and the modifications for each of these contribution requisite to making a prediction (refer to figure 6-1).

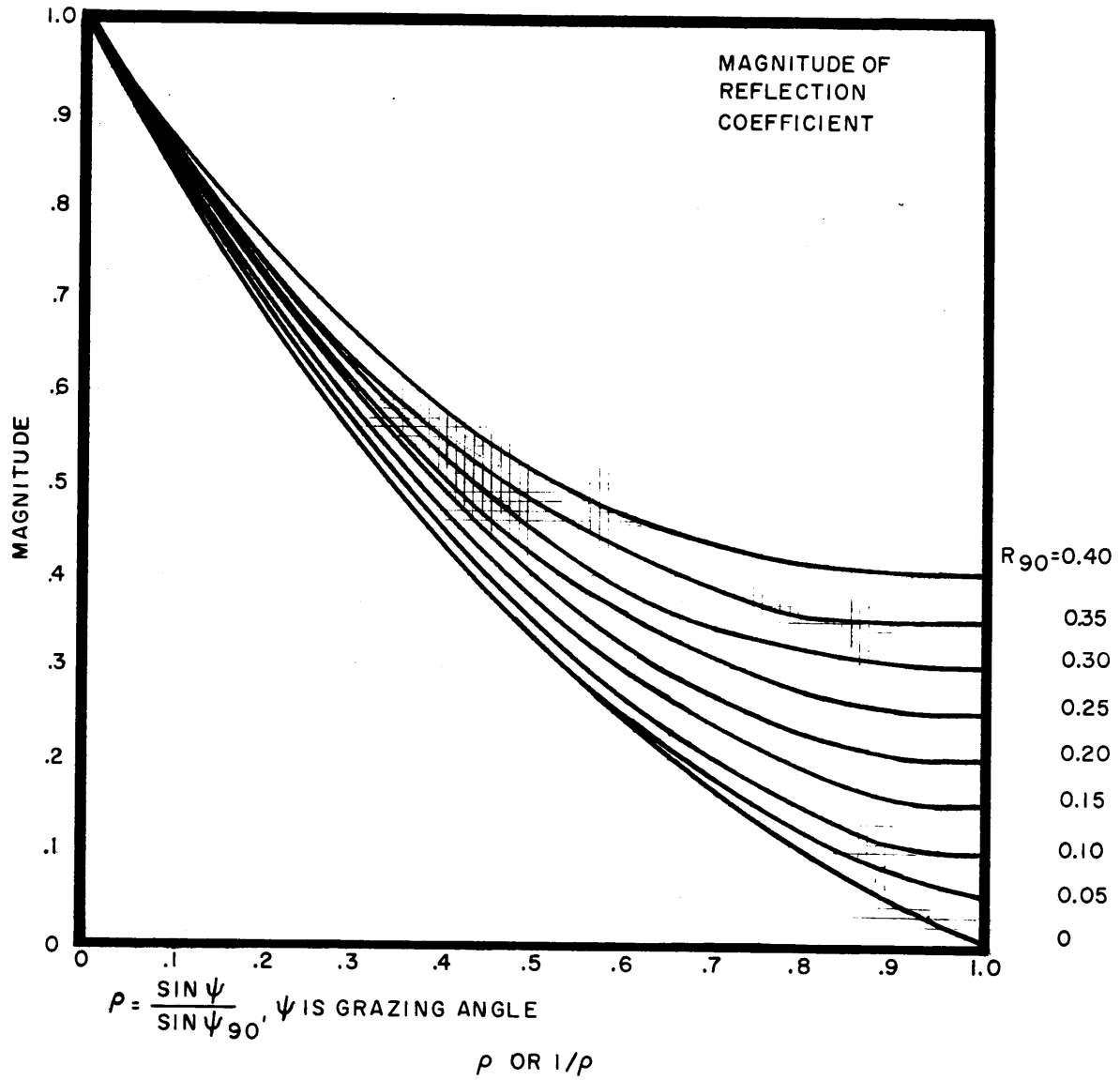
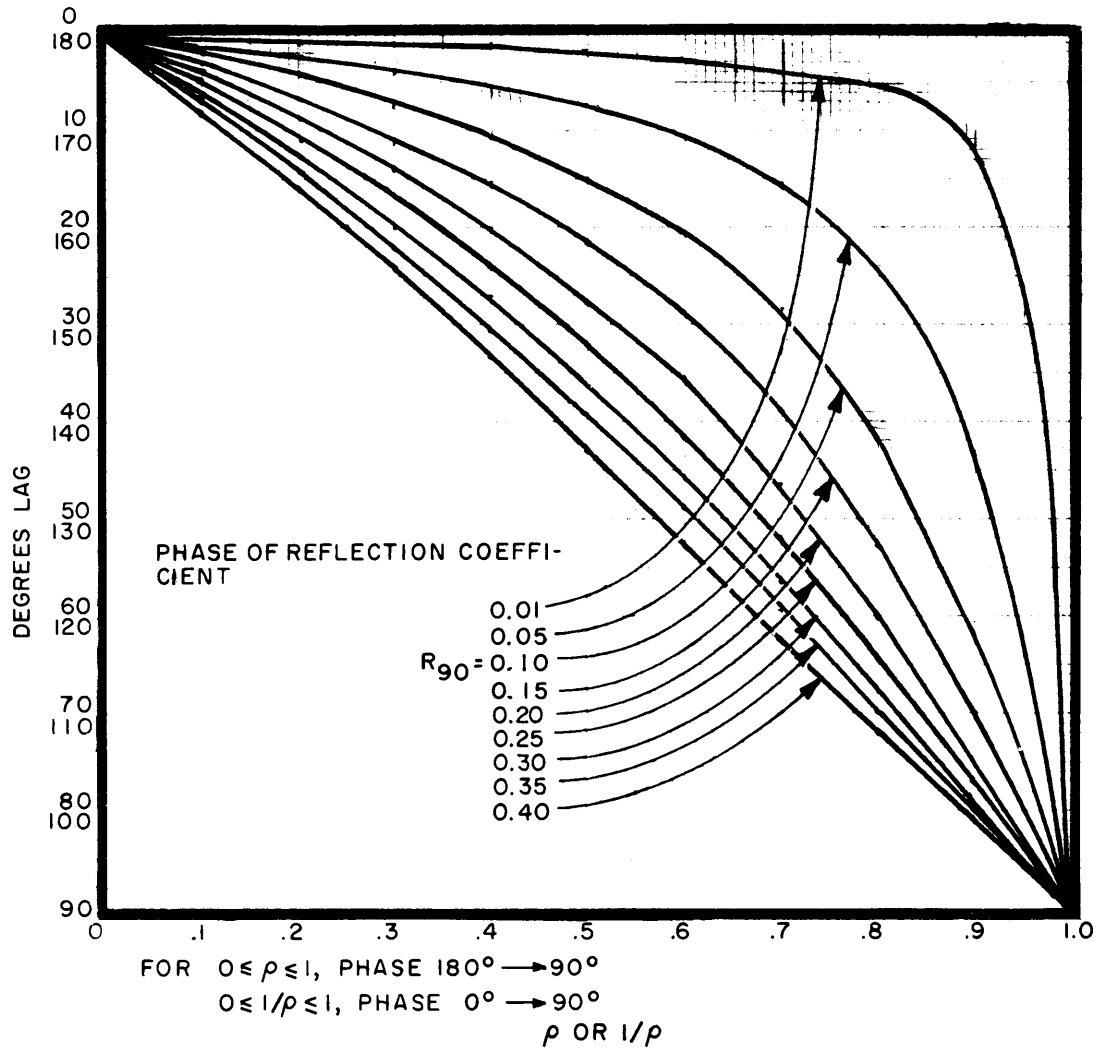

Figure 6 - 32. Magnitude of Reflection Coefficient



AIAF191

Figure 6 - 33. Phase of Reflection Coefficient

o EXPLANATION OF ENTRIES IN RECEIVER SECTION OF THE CALCULATION SHEET

This section discusses how each of the variables may be calculated or estimated to describe the dynamic situation for the principal types of receivers considered in this report, i.e., radar receivers, communications receivers, and microwave relay receivers.

o LINE 3.1, LOSS DUE TO POLARIZATION MISMATCH:  $P_{dB}$

This entry is the measured loss due to the difference in polarization between an arriving wave and the receiver antenna. If this loss is not known, it can be approximated by the use of Table 6-9. This table is based on a statistical compilation of measurements on the polarization loss in radar antennas.

Table 6-9. Transmitter - Receiver Polarization Alignment Factors  
(Expressed In Units Of dB Loss)

		ARRIVING OR TRANSMITTER POLARIZATION					
		Horizontal $L_p$	Vertical $L_p$	Diagonal $L_p$	Elliptical $L_p$	Circular RH $L_p$	Circular LH $L_p$
RECEIVER POLARIZATION	Horizontal	0	20	3	3	3	3
	Vertical	20	0	3	3	3	3
	Diagonal	3	3	0	3	3	3
	Elliptical	3	3	3	0	5	5
	Circular RH	3	3	3	5	0	25
	Circular LH	3	3	3	5	25	0

o LINE 3.2, RX EFFECTIVE ANTENNA AREA:  $10 \log A_r$

This entry pertains to the effective area of the receiver antenna. If this quantity is known, it should be entered in the equation in Line 3.2 in units of meters squared. If the effective area is less than 1 meter, this quantity will be negative and should be entered in Column "B" (-dB). If the area is greater than 1 square meter the quantity should be entered in Column "A" (+dB). If this quantity is not known, Lines 3.2.1 through 3.2.3 should be filled out.

o LINE 3.2.1, CONSTANT

This is a constant of proportionality which converts the RX Effective Antenna area into the antenna gain in dB above isotropic and frequency in MHz. It is always + 38.6 dB and is entered in Column "A".

o LINE 3.2.2, RECEIVER RADIO FREQUENCY:  $-20 \log f_{MHz}$

This term expressed in dB corresponds to the operational receiver radio frequency in MHz. For convenience, this term is plotted in figure 6-34.

## NAVELEX 0101,106

### o LINE 3.2.3, RX ANTENNA GAIN: $G_r$ (dB)

The explanation for Line 1.3 applies equally well here.

### o LINE 3.2.3.1, LOSS DUE TO OFF-AXIS POINTING AT TX:

The explanation for line 1.3.1 is the same as for line 3.2.3.1

### o LINE 3.2.3.2, LOSS DUE TO NEAR FIELD EFFECT:

The explanation of the near field effect in Line 1.3.2 applies here also.

### o LINE 3.3, RX TRANSMISSION LINE LOSS L (dB)

See discussion for line 1.2

### o LINE 3.4, SUBTOTAL COLUMN A

This entry is the sum of entries 3.2, 3.2.1, 3.2.2 and 3.2.3 shown in Column A.

### o LINE 3.5, SUBTOTAL COLUMN B

This entry is the sum of entries 3.1, 3.2, 3.2.2, 3.2.3.1, 3.2.3.2, and 3.3 shown in Column B.

### o LINE 3.6, TOTAL

Line 3.6 represents the factor which translates the interference power present at the receiver antenna to that present at the receiver input terminals. This quantity is determined by subtracting the absolute value of Line 3.5 from Line 3.4.

### o LINE 3.7, RECEIVED INTERFERENCE POWER (dBm)

This entry represents the interference power present at the receiver input terminals. It is obtained by adding algebraically Lines 2.9 and 3.6. The total of these two items is then entered in Column C or D, whichever is applicable.

### o LINE 3.8, RX BANDWIDTH

The following entries consider the effect of the RX bandwidth on the interference power. Fundamental cochannel  $BW_{RX} > 2/\tau$  is not included on the calculation sheet because the receiver will accept all of the transmitter power.

Figures 6-35 and 6-36 illustrate the bandwidths of certain AM and FM receivers which operate in various portions of the frequency spectrum. These entries are all calculated with respect to a megahertz, therefore, when the bandwidth is less than a megacycle the quantity goes in Column "B" (-dB). If the bandwidth is greater than a megahertz the value goes in Column "A".

### o LINE 3.8.1, FUNDAMENTAL COCHANNEL INTERFERENCE WHERE $BW_{RX} < 2/\tau$ (RADAR TX)

This line represents the interference case for which the receiver 3 dB bandwidth is less than the theoretical transmitter 3 dB bandwidth. The amount of power entering the cochannelly located receiver becomes a function of both the transmit and receive bandwidths.

#### o LINE 3.8.1.1, $\log 0.5\tau BW_{RX}$

This equation determines the amount of power admitted by the bandwidth of the receiver discussed in Line 3.8.1.

### o LINE 3.8.2, FUNDAMENTAL ADJACENT CHANNEL INTERFERENCE (RADAR TX)

This line represents the case of the above interference for which the receiver will accept an amount of transmitted power whose bandwidth is equal to the receiver's bandwidth.

#### o LINE 3.8.2.1, $\log (BW_{RX})$ MHz

This equation determines the amount of power admitted by the bandwidth of the receiver as discussed in Line 3.8.2.

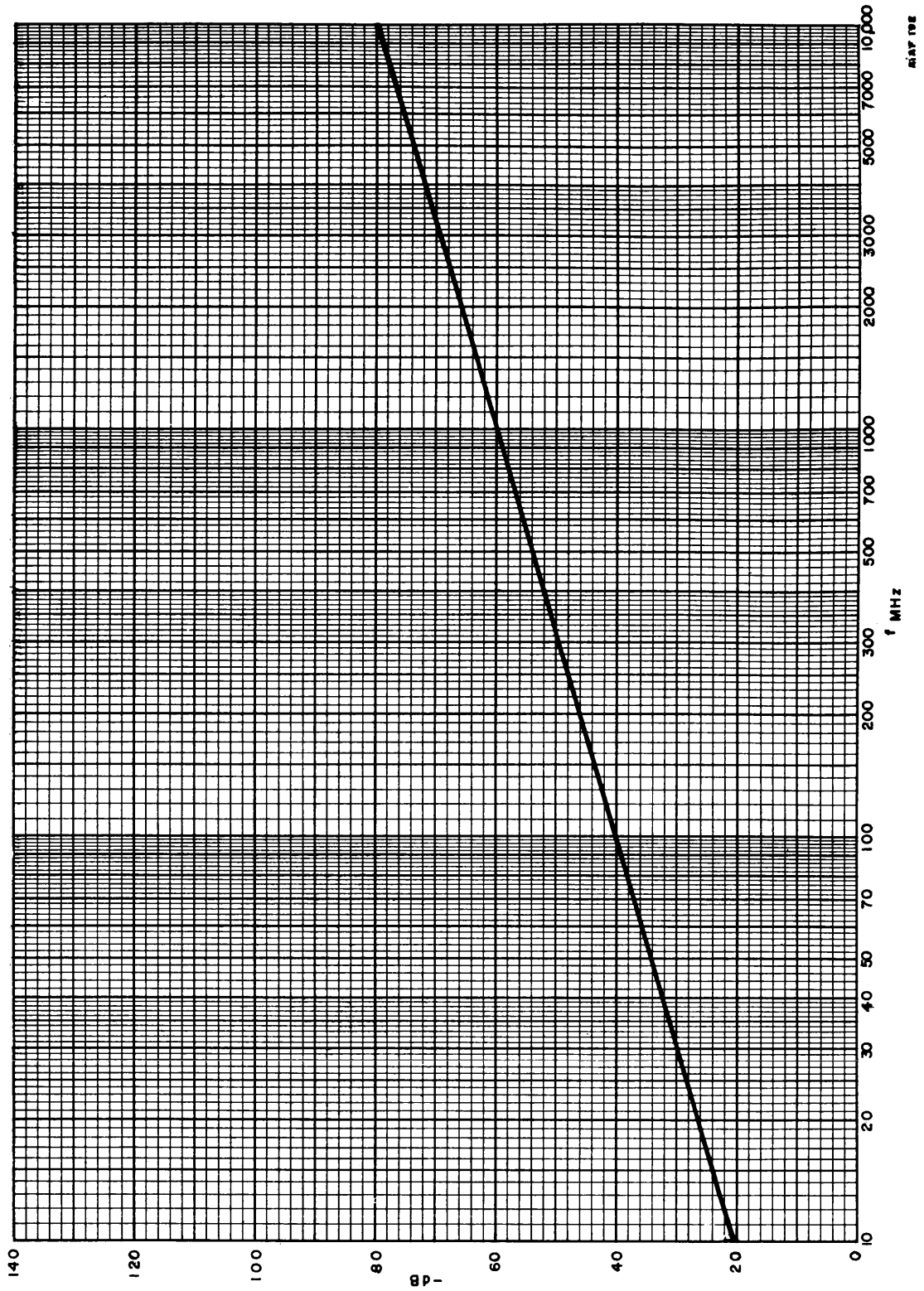

Figure 6 - 34. Graph of 20 Log f MHz

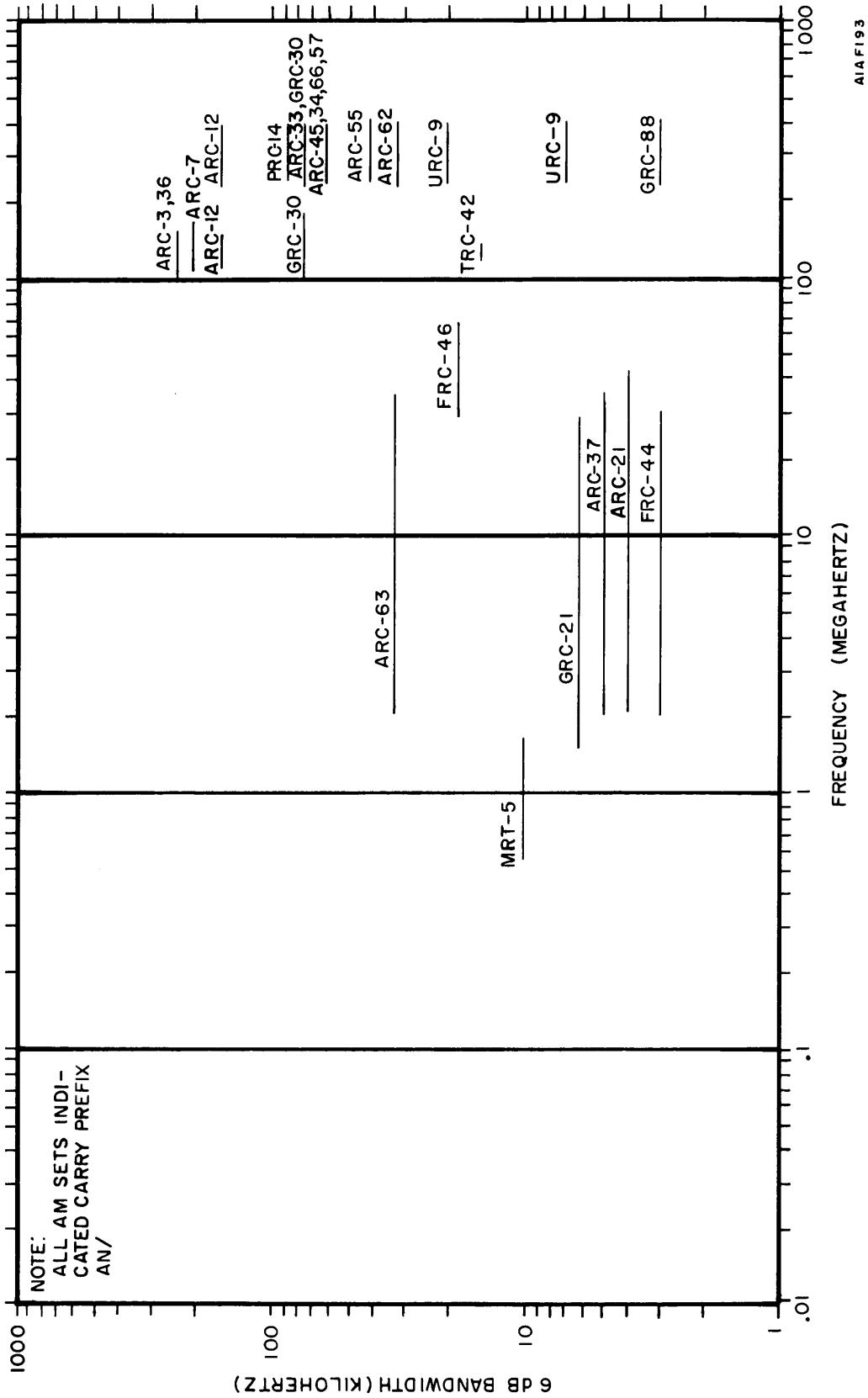
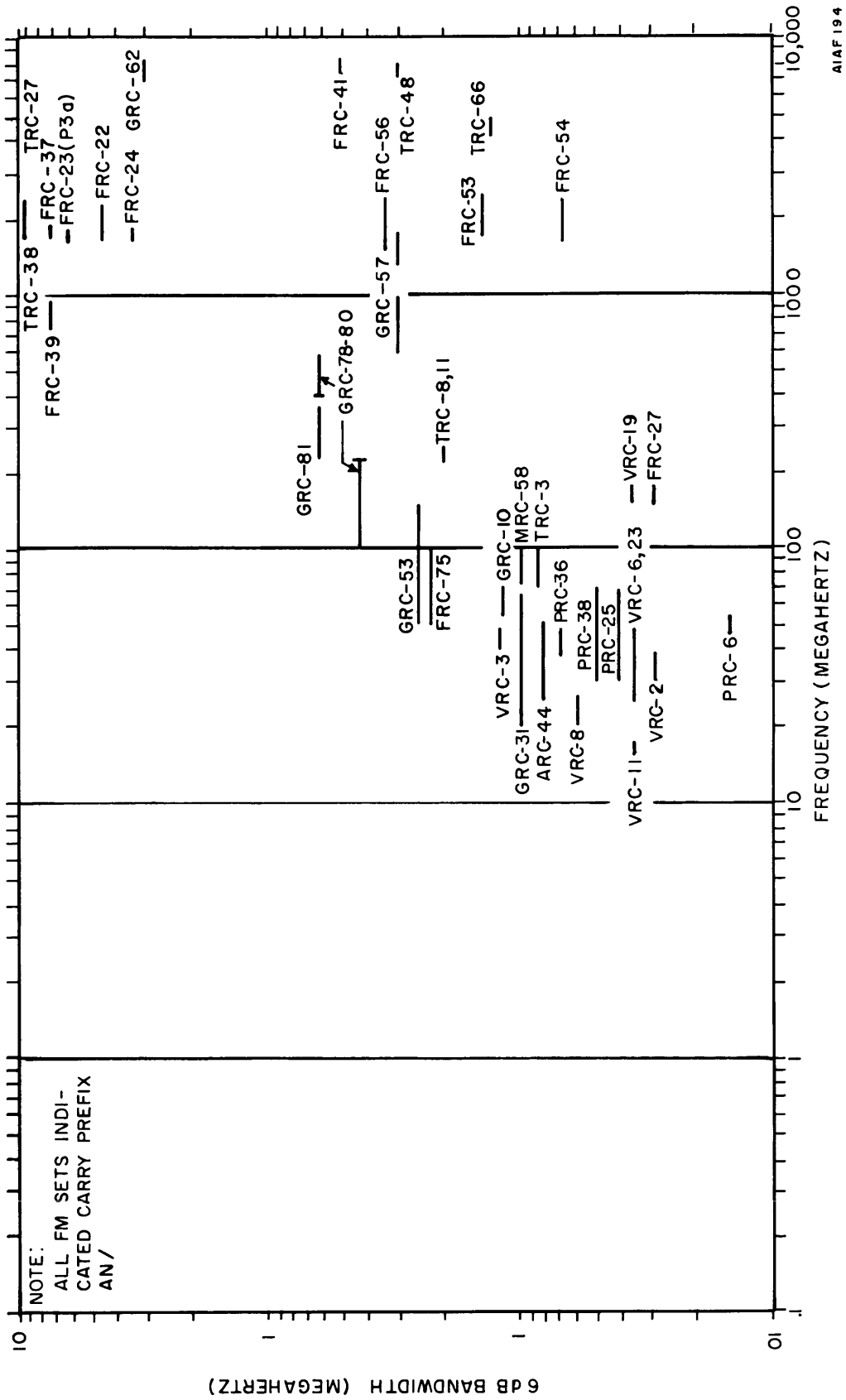

Figure 6 - 35. Bandwidth vs. Frequency, AM Sets





AIAF 19 4

Figure 6 - 36. Bandwidth vs. Frequency, FM Sets

o LINE 3.8.3, HARMONIC COCHANNEL INTERFERENCE WHERE  $BW_{RX} \ll \tau$  (RADAR TX)

The discussion for Line 3.8.1 and Line 3.8.3 is that the transmitted power level be correctly adjusted and this was accounted for Line 1.1.3.

o LINE 3.8.4, HARMONIC ADJACENT CHANNEL INTERFERENCE WHERE  $BW_{RX} \ll \tau$  (RADAR TX)

The discussion presented in Line 3.8.2 is valid for this line also, since the only difference between the case of EMI for Line 3.8.2 and Line 3.8.4 is that the transmitted power level must be adjusted accordingly. This was done in Line 1.1.4.

o LINES 3.8.5 and 3.8.6, RX BANDWIDTH EFFECTS ON TRANSMITTED POWER BY COMMUNICATIONS TRANSMITTERS

These two lines represent the amount of transmitted power admitted to a receiver when the transmitter in question is a communications transmitter. Lines 3.8.5 and 3.8.6 evaluate the ratio of the receiver and the transmitter bandwidths.

o LINE 3.9, RX SENSITIVITY IN UNITS OF -dBm;  $N_{dBm}$

This is the threshold receiver sensitivity (expressed in -dBm) and is normally available from the manufacturer's specifications. If necessary, it may be estimated by the use of figure 6-37 and the following equation:

$$N = (\text{sensitivity from figure 6-37}) + Z + 10 \log BW_{RX} \tag{6-26}$$

Where:

Z = 0 for 100 percent AM

Z = 5 for FM of any deviation ratio

$BW_{RX}$  = the receiver 3 dB bandwidth in kHz

The previous equation does not apply, however, to microwave relay receivers. A sensitivity of -55 dBm should be assumed for microwave relay receivers, unless design or measured data are available.

o LINE 3.10, SUBTOTAL, LINE 3.8 THROUGH 3.9 EXISTING IN COLUMN "A"

Line 3.10 is the sum of all entries from Line 3.5 through 3.9 in Column A.

o LINE 3.11, SUBTOTAL, LINE 3.8 THROUGH 3.9, COLUMN "B"

This entry is the sum of all entries in Column "B" from Line 3.8 through 3.2.

o LINE 3.12, TOTAL, LINE 3.10 - Line 3.11 = ADJUSTED RX THRESHOLD

By subtracting the absolute value of Line 3.11 from 3.10, a value is obtained for the receiver threshold which has been adjusted to the particular type of interference being received.

o LINE 4.1, I/N RATIO, TOTAL OF LINE 3.7 + LINE 3.12

This entry represents the interference power existing at the receiver input terminals referenced to the adjusted receiver threshold. The I/N ratio is obtained by algebraically adding the received interference power (Line 3.7), Column C or D, to the adjust RX threshold (Line 3.12), Column C or D.

o LINE 4.2, ASSUMED OR KNOWN (S/N)<sub>dB</sub> RATIO

To predict S/I, it is necessary to know the operational signal-to-internal-noise ratio of the potentially interfered receiver. This may be measured, calculated, or obtained from user or manufacturer's application data and is entered in Column C. The following discussion will assist in estimating the operational S/N ratio.

o RADAR OPERATIONAL S/N RATIOS

The classical radar equation can be used to calculate the ratio of received signal power to radar receiver noise when the radar is echo tracking.

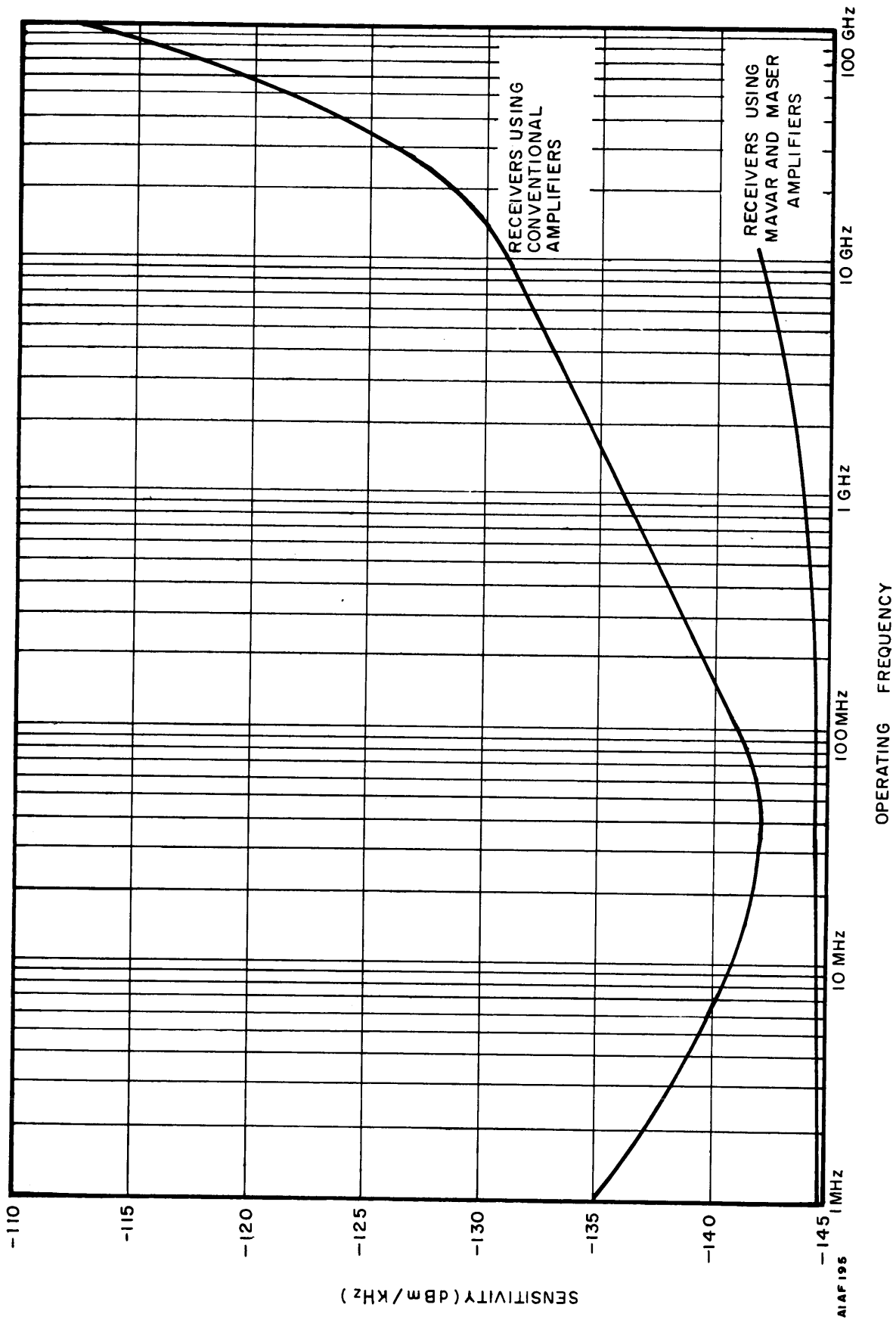

Figure 6 - 37. Typical Receiver Sensitivity (dBm)

$$S/N = 10 \log \frac{P_t G^2 \lambda^2 A}{(4\pi)^3 R^4 KTB NFL} \quad (\text{dB}) \quad (6-27)$$

where:

- $P_t$  is the transmitted peak power in watts
- $G$  is the main lobe antenna gain (dimensionless)
- $\lambda$  is the wavelength (meters)
- $A$  is the cross section area of the target (meters)<sup>2</sup>
- $R$  is the range to the target (meters)
- $K$  is Boltzmann's Constant =  $1.38 \times 10^{-23}$  joules/deg.
- $T$  is the temperature at the receiver in degrees Kelvin
- $B$  is the bandwidth in hertz
- $NF$  is the receiver noise figure (dimensionless)
- $L$  represents the various losses encountered in the entire system (dimensionless).
- $S/N$  is the IF signal-to-noise ratio during reception of the pulse.

Equation 6-27 represents the S/N ratio for any specific situation.

The operational signal-to-noise ratio of the FPS-16 is 16 (12 dB) and is typical for tracking radars in this class. The operational S/N ratio for most radars falls in the area of + 10 dB and this quantity may be used if no other estimates are available.

o COMMUNICATIONS OPERATIONAL S/N RATIOS

As in the case of radars, the operational S/N ratio can only be determined by the individual user. However, table 6-10 can be used to estimate S/N ratios for various types of communications systems.

o MICROWAVE RELAY RECEIVERS

The S/N ratio of microwave relay links is typically about 20 dB and is generally maintained through a 30 dB signal fade.

o LINE 4.3, FIGURE PREDICTED (S/I) RATIO

Since it is ultimately the S/I ratio that is used as an operational measure of the potential EMI due to radiations from transmitters, this ratio is determined by subtracting I/N ratio (Line 4.1) from the S/N ratio (Line 4.2).

Table 6-10. Signal - to - Noise Ratio

TYPE OF RADIO SERVICE	APPROXIMATE MINIMUM S/N (DECIBELS)
1. Double-sideband radiotelephony (3 kilohertz bandwidth)	20
2. Single-sideband radiotelephony (3-kilohertz bandwidth)	20
3. Broadcasting (5-kilohertz bandwidth)	20
4. Manual morse radiotelegraphy (for average operators)	0
5. Frequency-shift radiotelegraphy (60-word teleprinter speed)	10
6. Single-sideband two-tone radiotelegraphy, one tone marking and one tone spacing, 60-word speed	8
7. Single-sideband four-tone radiotelegraphy, two tones marking and two tones spacing, 60-word speed	6
8. Radio facsimile with 8-decibel contrast ratio using double-sideband amplitude modulation	18
9. Radio facsimile with 8-decibel contrast ratio using carrier-shift	12

- o LINE 4.3.1, FOR  $I/N > 0$  dB;  $(S/I)_{dB} = (S/N)_{dB}$  LINE 4.2 - LINE 4.1

Should the I/N ratio be greater than zero (LINE 4.1 is positive) the calculation of S/I is made here. This quantity will be negative unless the I/N (Line 4.1) ratio has a value which lies between 0 dB and  $-(S/N)$  ratio, in which case Line 4.3.1 will have a small positive value.

- o LINE 4.3.2, For  $I/N \leq 0$  dB;  $(S/I)_{dB} = (S/N)_{dB}$  NO INTERFERENCE EXISTS

Should the I/N be less than or equal to zero, (Line 4.1 is negative) the S/I ratio will be due to the inherent noise characteristics of the receiver alone and not due to the selected transmitter. Hence, EMI is said not to exist.

## 6.6 INTERPRETATION OF RESULTS

Once the S/I ratio existing at the subject receiver input has been determined (Line 4.3.1) it is necessary to translate these S/I ratios to the presentation device, which may be visual, voice or in terms of intelligibility content. These ratios can then be used as a basis for either making recommendations, or taking corrective action. A nominal criteria for the static scoring of the calculated S/I ratios is given in Table 6-11. In those situations where one or both of the antennas are scanning, it is necessary to modify the static criteria to include the time variant effects.

Table 6-11. Scores and Interpretations of S/I Ratios

SCORE	INTERPRETATION	DIGITAL DATA OR RADAR*	VOICE	TV AND FAX
A	Highly improbable	$S/I \geq 25$	$S/I \geq 10$	$S/I \geq 35$
B	Unlikely	$15 \leq S/I < 25$	$0 \leq S/I < 10$	$25 \leq S/I < 35$
C	Marginal	$5 \leq S/I < 15$	$-10 \leq S/I < 0$	$15 \leq S/I < 25$
D	Likely	$-5 \leq S/I < 5$	$-20 \leq S/I < 10$	$5 \leq S/I < 15$
E	Highly probable	$S/I \leq -5$	$S/I < -20$	$-5 \leq S/I < 5$

\* Based on isotropic illumination.

### 6.6.1 Static Scoring Criteria

Nominal user value judgements versus the mean S/I are given in figure 6-38 for voice, digital data, radar return, television or fax. The nominal voice scores are based on studies of military field test data made by the U.S. Army Electronics Command (USAECOM) at Ft. Monmouth; the digital data scores are based on an averaging of many data links for the TD-2 microwave relay; and the TV scores are based on an averaging of the acceptability criteria developed by the Television Allocation Study Organization. A further statistical ordinate for scanning radars is presented on the right margin.

These values are subjective and wherever specific scoring, or decision criteria are available to those making predictions, these criteria should replace the nominal subjective judgements suggested in figure 6-38.

The process of EMI prediction has many uncertainties giving rise to the question of what confidence value to be placed on the results obtained. The user scores depicted in figure 6-38 have a probable variation (uncertainty) of  $\pm A_{\mu}$  corresponding to an error interpreted to be "Good" when it should have been "Poor" or vice versa. The  $A_{\mu}$  is smaller for digital data and larger for TV as evidenced in Table 6-11. The predicted S/I has an attendant uncertainty,  $A_{\rho}$ , due to the statistical combination of the variations in transmitter power, propagation loss, receiver properties, etc. The total probable variation,  $A$ , is the statistical sum of each variation.

$$A = \sqrt{A_{\mu}^2 + A_{\rho}^2} \quad (6-28)$$

The interpretation now to be put on  $A$  is that any score (good, poor, etc.) will likely be in error by  $\pm A$ . Empirically,  $A$  is believed to be at least as great as 5 dB when uncertainties due to many situations are averaged. Toward this end, Table 6-11 is obtained from figure 6-38 but each score grade now has a  $\pm A$  or 10 dB range to allow for the uncertainty in the prediction and scoring processes. The exception, of course, is for the "A" and "F" scores since a S/I ratio which is arbitrarily large (A score) can score no better than "no interference" and conversely. In estimating the likelihood that interference both exists and is damaging to the "ability-to-communicate," Table 6-11 should be used, unless better, or more specific data are otherwise available.

### 6.6.2 Dynamic EMI Scoring

The word, dynamic, as used here, means a time-changing S/I ratio produced by a scanning antenna system of either the interference source, the offended receiver, or both. The most common case is when either, or both, are radars of the search/surveillance or height finding type.

Dynamic EMI scoring is important in predicting the interference to or from radars since the most pessimistic case (when two radars are momentarily looking at each other) generally exists on the order of only 0.01 percent of the time. When this occurs (generally for a duration on the order of 50 milliseconds), the S/I level may increase by about 60 dB or more. Yet, this "flash-in-the-pan" interference may often be of little or no significance. Therefore, a dynamic (statistical) look at the resulting S/I is necessary if any significant meaning of EMI is to be concluded.

### 6.6.3 EMI Analysis Sheet

Figure 6-39 depicts the EMI Analysis sheet employed for dynamic EMI scoring. In practice, the procedure for computation is quite straight-forward. Using the EMI Prediction Form, compute the S/I ratio corresponding to the worst possible situation of mutual antenna alignment. This will probably correspond to Condition No. 1 of figure 6-40.

If only one equipment is scanning, then some other condition applies as clarified in Cases B and C of figure 6-40.

The predicted maximum S/I ratios corresponding to one of the three cases depicted in figure 6-40 is entered in Column 3 for the associated condition in figure 6-39. If this worst case should correspond to a S/I ratio of greater than about 0 dB, there is no need to make any further computations since EMI can be assumed to be nonexistent. The percent of time that this S/I exists is then entered under Column 4 and is computed by using the  $G_0$  curve in figure 6-41. The actual entry in Column 4 depends upon which of the three cases in figure 6-40 exists. For Case A, multiply the "percent time" factors corresponding to both transmitter and receiver antennas  $G_0$ 's, and then multiply the result by 0.01. For either Case B or C enter the percentage directly.

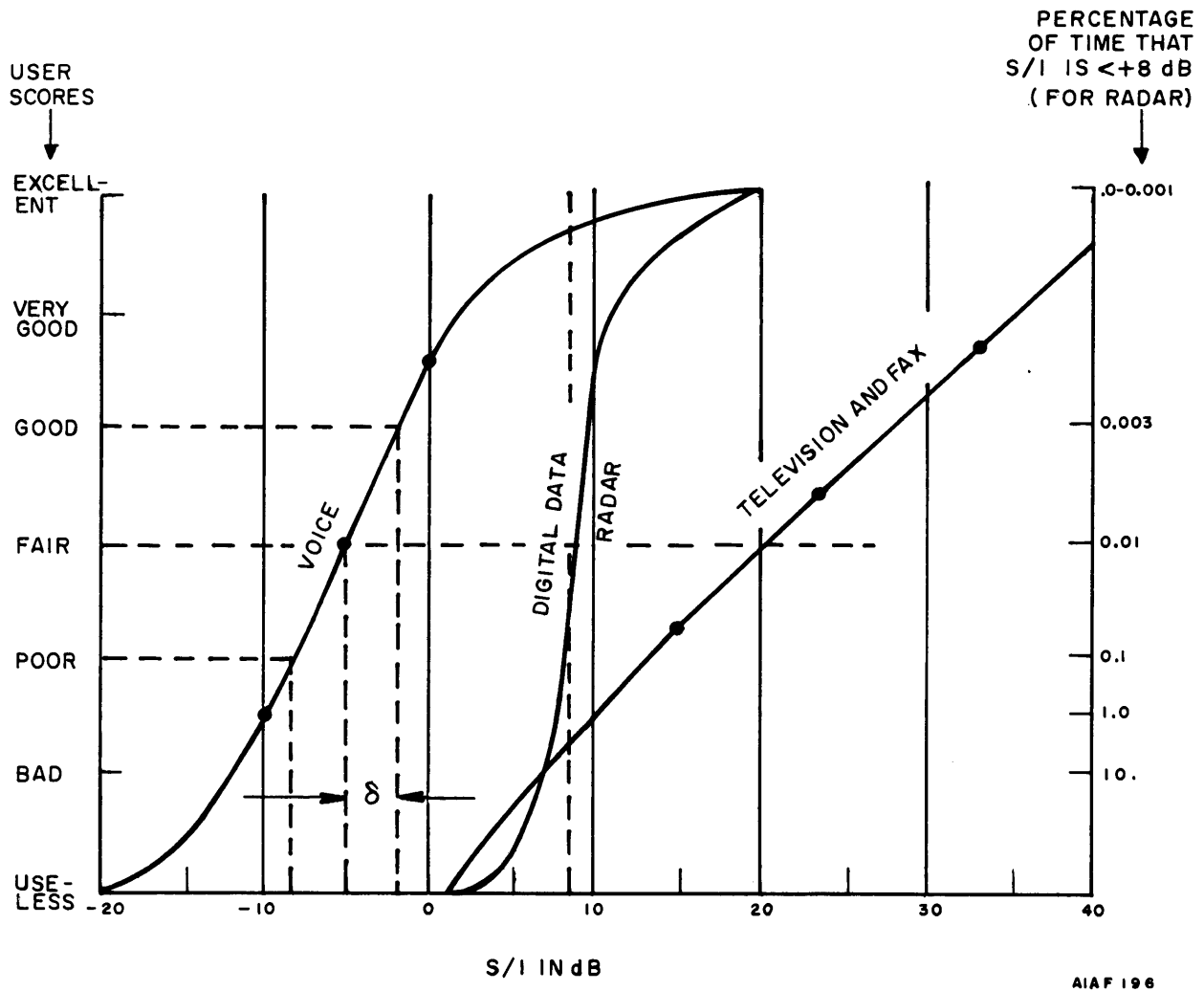
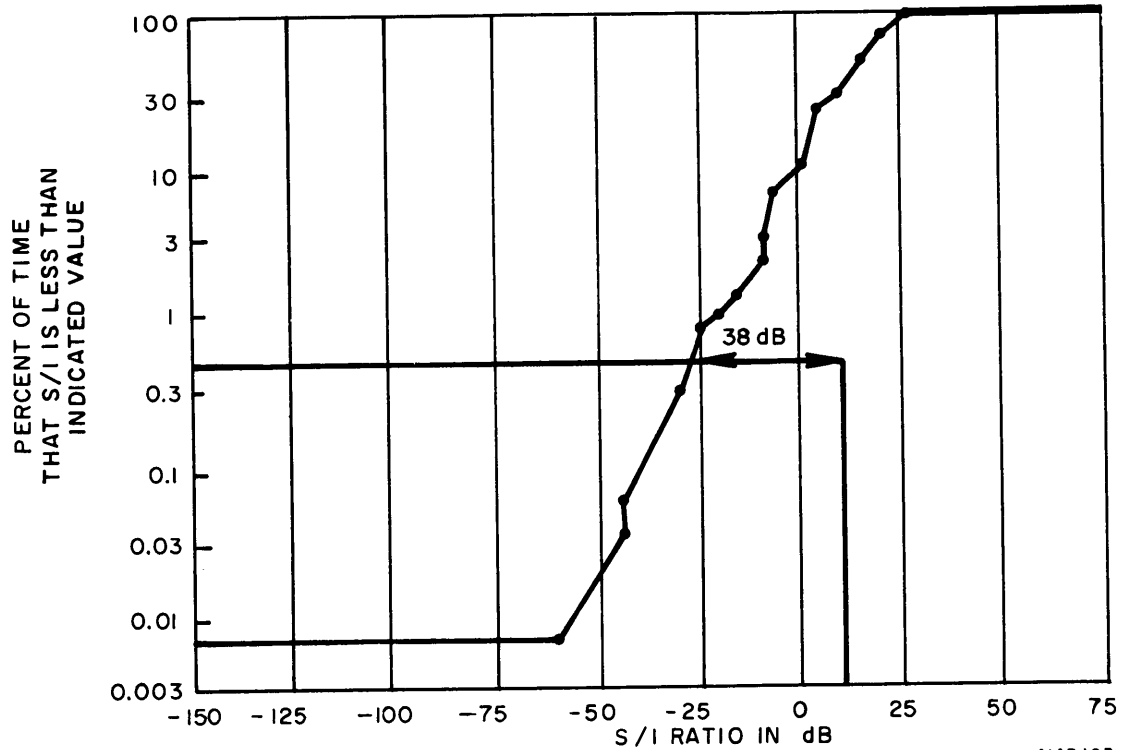

Figure 6 - 38. Nominal User Value Judgments of S/I Situations

1 NO. TX LOBE	2 RX LOBE	3 S/I(dB)	4 % TIME	5 ASCENDING S/I (dB)	6 % TIME	7 RUN TOTAL % TIME	
1	MAIN(G <sub>0</sub> )	MAIN(G <sub>0</sub> )	-60	0.007	-60	0.007	0.007
2	MAIN(G <sub>0</sub> )	MAJOR(G <sub>1</sub> )	-40	0.03	-40	0.03	0.037
3	MAIN(G <sub>0</sub> )	MINOR(G <sub>2</sub> )	-28	0.21	-40	0.03	0.067
4	MAIN(G <sub>0</sub> )	BACK(G <sub>3</sub> )	-18	0.24	-28	0.21	0.277
5	MAJOR	MAIN	-40	0.03	-23	0.70	0.977
6	MAJOR	MAJOR	-20	0.05	-20	0.05	1.03
7	MAJOR	MINOR	-8	0.60	-18	0.24	1.27
8	MAJOR	BACK	+2	0.70	-8	0.60	1.87
9	MINOR	MAIN	-23	0.70	-8	0.70	2.57
10	MINOR	MAJOR	-3	2.00	-3	2.00	4.57
11	MINOR	MINOR	+9	21.40	+2	0.70	5.3
12	MINOR	BACK	+19	24.10	+9	21.40	26.7
13	BACK	MAIN	-8	0.70	+12	2.10	28.7
14	BACK	MAJOR	+12	2.10	+19	24.10	52.8
15	BACK	MINOR	+30	25.00	+30	25.00	77.8
16	BACK	BACK	+30	25.00	+30	25.00	100.0

$G_1 = G_0 - 20 \text{ dB}$



AIAF 197

Figure 6 - 39. Dynamic EMI Analysis Sheet



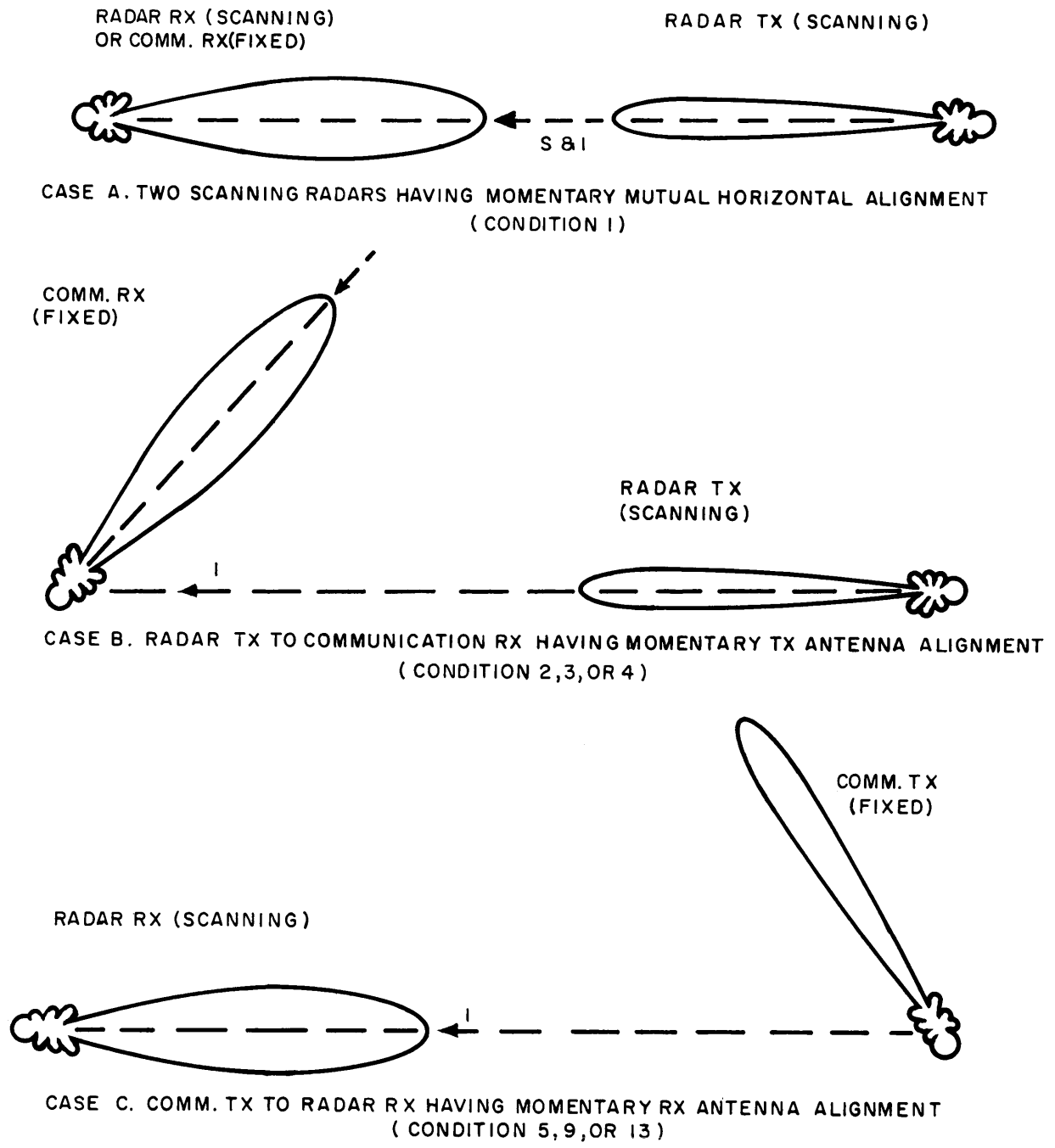

AIAF198

Figure 6 - 40. Illustrating Three Cases of Worst Antenna Illumination for Computing Maximum S/I Ratio

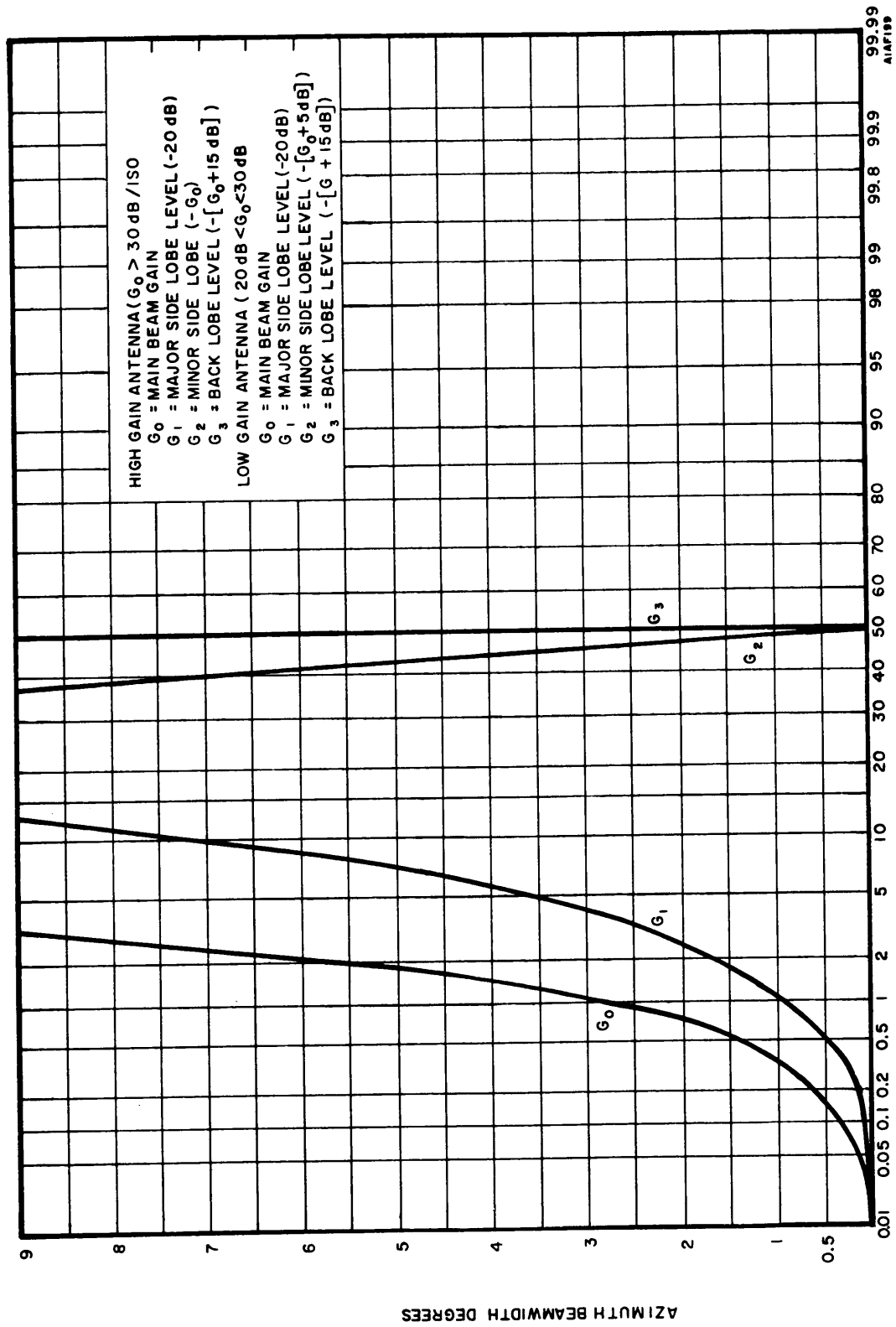

Figure 6 - 41. Percent of Time Gain Obtains

When the worst case is computed and entered in figure 6-39, the entries corresponding to all other antenna orientations can be linearly projected. This is achieved by reducing the original S/I values as indicated in both figures 6-39 and 6-41. Finally, the corresponding percent time that the different gain combinations exist are picked off figure 6-41, their products formed as before, and the entries made in Column 4 of figure 6-39.

Figure 6-39 has been set up on the basis that each successive S/I value will usually be ascending (values become more positive or less negative). If this is not the case, then Column 5 should be used to transfer Column 3 entries such that every successive S/I entry is ascending. If Column 5 is used, then the associated percent of time entry should be carried over into Column 6. Whether or not Columns 5 and 6 must be used, Column 7 is the running total of Column 4 entries (or Column 6 if this had to be used). The running total is computed by transferring the first entry in Column 4 (or Column 6) into the first entry of Column 7. The second entry in Column 7 is obtained by adding the second entry in Column 4 (or Column 6) to the first entry in Column 7. The third entry in Column 7 is obtained by adding the second entry in Column 4 (or Column 6) to the second entry in Column 7. The process is repeated until the last (16th) entry in Column 7 is obtained. This entry should total  $100.0\% \pm 1.0\%$ . If it does not, then the computation should be rechecked for errors.

The graph on the lower half of figure 6-39 for plotting the cumulative percent of time (Column 7) that any S/I level (Column 4 or 6) has been exceeded. From this plot, and from both the system performance requirements and scoring criteria discussed previously it is then possible to determine how much the offending interference must be reduced to make the C-E system meet satisfactory performance. The following example will help to clarify some of these points.

This is an example utilizing the dynamic analysis sheet. Assume a two L-Band scanning radar situation in which the horizontal antenna beamwidths are  $1.3^{\circ}$  and  $4.0^{\circ}$  and the relative gains are 37 dB and 27 dB, respectively. Further, assume that the predicted S/I level corresponding to the antennas illuminating each other is -60 dB.

To determine the total percentage of the time a specified S/I level is exceeded, the following computations are made:

a. For transmitter main lobe to receiver main lobe

(1) Enter preceding figure 6-41 at the  $1.3^{\circ}$  ordinate and read the abscissa (0.5 percent) from the  $G_0$  plot.

(2) Repeat for the  $4^{\circ}$  beamwidth which yields a value of 1.4 percent.

(3) Multiply  $(0.5)(1.4) \times 10^{-2} = 0.007$  percent and enter this value in Column 4, Condition 1.

b. For transmitter main lobe to receiver major lobe

(1) Enter preceding figure 6-41 at the  $1.3^{\circ}$  ordinate and read the abscissa (0.5 percent) from the  $G_0$  plot as before)

(2) Enter the  $4^{\circ}$  ordinate and read the abscissa (5.8 percent from the  $G_1$  plot )

(3) Multiply  $(0.5)(5.8) \times 10^{-2} = 0.029$  percent and enter this value in Column 4, Condition 2.

(4) Reduce predicted S/I level by side lobe level (20 dB) and enter this value of -40 dB (-60 + 20) into Column 4.

The process is repeated as shown in figure 6-39. Column 5 is plotted as the abscissa vs Column 7 as the ordinate. All end points are connected by a straight line. The graph in figure 6-39 is extremely useful in determining performance. For example, suppose that the offended radar is reading out blocks of digital words representing target coordinates, velocities, etc. Let it be supposed that the maximum allowable target word error rate for the system redundancy involved is one-half percent. This may also correspond to a S/N ratio of about 12 dB in which an error in any character is scored as a word error. Figure 6-39 shows the point location of this required performance.

Figure 6-39 indicates that the required 12 dB S/I ratio is about 38 dB greater than the -26 dB S/I ratio due to the dynamic nature of the scanning process. Therefore, it can be concluded that at least 40 dB of interference rejection must be provided to the culprit source if the offended radar is to be made compatible. The flexibility of using the plot in figure 6-39 is apparent since the required S/I improvement can be readily determined for any system performance specifications.

## 6.7 APPLICATION OF RESULTS

There are two basic types of EMI problems associated with a Naval Shore Station. The first is the problem of predicting the interference that will result from the installation of new or additional equipment. A different aspect of this EMI problem is the selection of sites on the station which will result in the minimum amount of interference. By applying the EMI prediction technique presented in this report, it is possible to predict the EMI problems that will occur when the equipment is installed. This technique can be used to determine the desirability of the installation, and if the installation is to be made (despite EMI problems) to minimize preparation time for eliminating the problem after the equipment has been put in operation.

The second type of problem is the elimination of EMI situations which currently exist. In problems of this type, the technique will determine the extent of the interference, as well as the source, if it is unknown. By comparing the interference-to-noise ratio that exists at the receiver input terminals with the acceptable signal-to-noise level for the receiver, it is possible to determine the improvement required to eliminate the problem.

This required improvement can then serve as a basis for the selection of the simplest suppression technique that will provide desired improvement. For example, if an improvement of only a few dB is required, the problem may be eliminated by slightly off-tuning the receiver; whereas, if 20 or 30 dB improvement is required it may be necessary to install filters on the transmitter to eliminate the problem.

The following sections provide information to facilitate the application of the prediction technique to the various types of problems.

### 6.7.1 Siting Considerations

A Naval Shore Station offers relatively little flexibility in the selection of C-E equipment sites; the area is normally small, and the terrain generally level. These factors make it difficult to select sites which will provide interference-free operation of equipment. At most stations installations are already in existence and therefore offer little or no flexibility in determining new sites. For example, VHF/UHF transmitters are housed and located in a specified area and receivers in another. Relocating these sites or a distribution of these sites may prove uneconomical. As a general rule, siting criteria for C-E equipments includes only general references to possible interference from the electromagnetic environment in which the equipment is to be installed, and practically never considers the effect of new installation on existing equipments. The primary stress in the development of the siting criteria should be to obtain the spectrum signature. The lack of electromagnetic environmental considerations is due to the complexity, as well as the spectrum signature variations, existing between equipments of the same class. A lack of electromagnetic environmental considerations is much more serious in the case of installations at Naval Shore Stations, since generally there is a large number of different types of equipment.

The application of the techniques presented in this report to a proposed installation will determine the degree of EMI to be expected. In those cases where several sites are available, this technique can be used to select a site which will minimize the EMI problems. The results of the technique will also provide a measure of the interference which will be experienced by the additional equipment.

In considering the installation of new or additional equipment to a station, the decision is normally based on the assumption that the new equipment will operate near its maximum capability and that the present system will not be affected. The results of the EMI prediction technique will provide those entrusted with making decisions with additional information to make their decision more realistic. For example, it may be desired to install a radar, which will provide longer range and improved coverage capability for the station. By applying the prediction technique it may be determined that, no matter where the radar is installed, it will experience almost continuous interference from a present radar as well as degrade the performance of a large number of communication equipments. This information can then be used to accurately assess the actual advantage that will be gained from the installation of this radar.

It is important to note that the prediction calculations will indicate the level of the interference likely to result. As will be discussed in the next section, it is possible that the potential EMI problems can be eliminated by appropriate suppression techniques. The use of these techniques should be included in evaluating proposed installations.

The advantage of having the knowledge gained by applying the prediction technique before an installation is made should be obvious. In certain cases the installation of the required suppression may be so extensive or costly that an equipment with different characteristics might actually be more desirable. If this is not determined prior to the installation, the suppression will have to be used or the reduced capability of the equipments accepted. Another important aspect is the fact that although there are numerous suppression techniques, many of them require modifications to the equipments or additional hardware be installed. If this is known prior to the installation, a program and schedule for modification may be drawn up so that installation down-time may be kept to a minimum and thus reduce the cost of implementing the technique.

The use of this technique in siting additional equipment at a Naval Shore Station is demonstrated in detail in the examples of EMI discrete prediction techniques.

#### 6.7.2 Recommendations For EMI Reduction

The suppression or reduction of EMI is an extremely complex subject. Techniques to eliminate interference can vary from simply turning off the interfering transmitter to redesigning the receiver. In many cases, particularly in high density electromagnetic environments, such as a Naval Shore Station, the interaction of various equipments requires a decision, whether to reduce or eliminate the interference situations. As mentioned previously, turning off the interfering transmitter will eliminate an EMI situation, but the question arises as to the value of the function provided by interfering equipments when compared with the value of the information lost because of the interference situation.

Another important criterion is the cost of the improvement. Many EMI situations can be eliminated by modifying the equipments involved. In these situations, the decision must be made as to whether the advantages gained by elimination of the situation warrant the cost required to obtain the improvement.

The most efficient method for eliminating interference will depend upon the nature of the situation. In order to select the best technique for a given case, it is necessary to determine the signal-to-interference ratio existing at the receiver input terminals. In those situations where the EMI prediction technique has been utilized the amount of improvement necessary to eliminate the subject EMI can be obtained as follows.

The signal-to-interference ratio will be shown in Line 4.3.1 of the EMI Prediction Calculation Sheet. The value of the signal-to-interference ratio which will give the desired performance, (EMI Highly Improbable) is found in the scoring table in Table 6-11. The improvement necessary, then, is simply the difference between the required signal-to-interference ratio and the calculated signal-to-interference ratio.

In those cases where the presence of EMI is actually determined by the operation of the equipments, it will still be necessary to apply the EMI prediction technique to determine the amount of improvement necessary to eliminate the subject EMI.

The flow diagram shown in figure 6-42 is provided to facilitate the selection of the simplest, most economical means of obtaining the necessary improvement once the necessary amount of improvement has been determined.

As shown on the diagram, the most desirable means of eliminating interference are changes to the receiver which do not involve hardware modifications (block 1). The various possible suppression techniques will be discussed following the explanation of the flow diagram. The next step is to compute  $\Delta_r$  S/I, the maximum improvement resulting from these changes. The predetermined S/I improvement is compared with the computed  $\Delta_r$  S/I value (diamond 3) to determine if sufficient improvement has been obtained. If improvement is sufficient ("yes" arm of diamond 3), a best or reasonable trial change is considered (block 4).

The trial change is next examined to see if a frequency change was involved (diamond 5). If no retuning is called for ("no" arm of diamond 5), then the trial change, or changes are offered as a recommended fix. If a change in frequency is indicated ("yes" arm of diamond 5), then, the S/I must be recomputed for other potential EMI sources (block 6), since it is possible to tune out of one EMI situation into another. If no other EMI situations developed ("no" arm of diamond 7) as a result of the recommended tuning, then, the trial change is offered as the recommended fix. If other EMI situations develop ("yes" arm of diamond 7), then new trial receiver changes are made until no new EMI situations develop.

If the "built-in" available  $\Delta_r$  S/I improvement involving the receiver only with no hardware changes should be inadequate ("no" arm of diamond 3), then quick-fix changes to the culprit transmitter not involving hardware (diamond 8) should be investigated. If simple transmitter changes can be made (block 9), then the new maximum available  $\Delta_r$  S/I (including effects due to simple receiver changes) should be computed. If the new value of  $\Delta_r$  S/I is adequate ("yes" arm of diamond 10), then trial changes (block 11), should be made and tested out. If recomputed values of  $\Delta_r$  S/I are still inadequate ("no" arm of diamond 10), then some fundamental alterations are probably required in the receiver hardware (block 12). These receiver changes are evaluated in terms of their maximum  $\Delta_r$  S/I as well as their cost and the lead time required. Again the improvement is tested (diamond 3), and the remainder of the program reiterated.

The identification of possible changes in the receiver and/or transmitter is the most critical portion of this method. Changes in the receiver are the most desirable in that they will not affect operation of the other equipments at the station. The simplest receiver change is to detune the receiver slightly off channel away from the interfering signal but still remaining within the transmitters bandwidth. Of course, this being a frequency change, it will require consideration of the possibility that a new EMI situation has been created. The receiver may also be tuned to another channel, but this would require changing the operating frequency of the transmitter radiating the desired signal. This changing of operating frequencies will be covered in more detail at the end of this section.

Another simple change which can provide as much as 4 or 5 dB improvement in some communication cases is to change the receiver antenna height, simply by patching in a similar antenna located higher or lower on the antenna site. The reflected interfering signal, in some cases, may reinforce the direct interfering signal. Thus, by changing the antenna height the geometry of the situation can be changed so that the reflected interfering signal will subtract from the direct interfering signal thereby reducing its strength at the receiver. In this process the desired signal may also be reduced, so the effects of this change should be carefully analyzed before it is applied.

AIAF 200

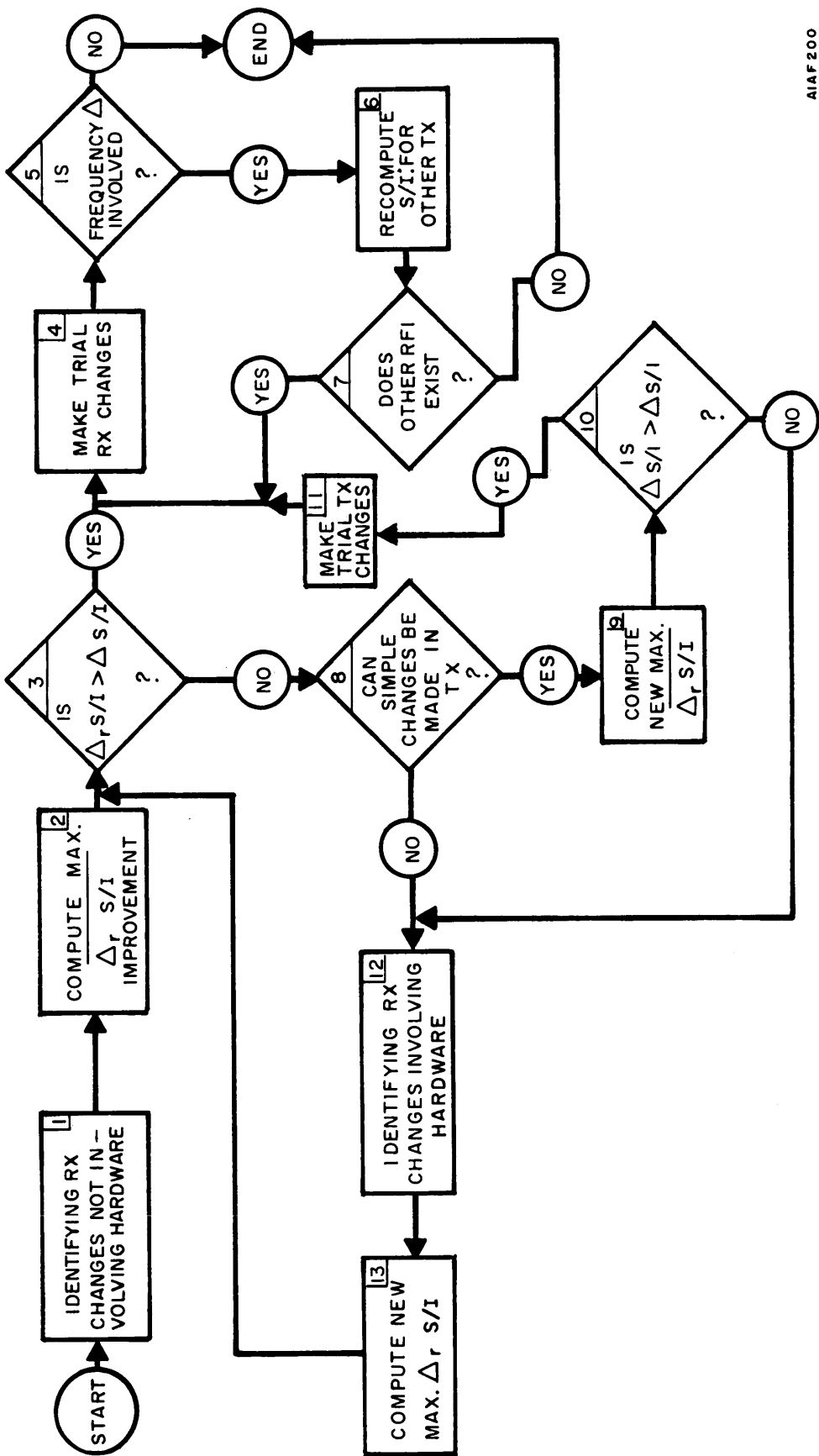

Figure 6 - 42. General Flow Diagram for Making EMI Correction Recommendations

The use of additional hardware or receiver modifications provide far more flexibility, but these changes must be examined in light of increased costs, and in some cases substantial lead time is required to implement the changes.

Fortunately, in recent years considerable effort has been expended in reducing the susceptibility of both communications and radar receivers to Electronic Counter-measures. Many of the techniques developed are equally applicable to problems of EMI. A radar fix, such as side-lobe suppression, where signals entering the sidelobes are canceled out, would be particularly desirable at a station where the radar is operating among other transmitters.

Other techniques that can be used effectively in certain situations are:

- o False alarm rate detection
- o Pulse width discrimination
- o PRR discrimination
- o Range gating
- o Image frequency preselection
- o Front-end filters

Some interference situations can be eliminated by the use of different antennas. Almost all of the communication antennas in use at Naval Shore Stations are omnidirectional. These antennas have a relatively low gain and allow undesirable signals to enter the receiver from any azimuth. In some EMI situations, it might be possible to employ directional antennas. It would be particularly advantageous for those cases where the source of the desired signal consistently remains in a relatively small azimuth sector. Take, for example, a case where communication is required with aircraft flying a direct route to or from another air station. A directional antenna may be used at long distances until the aircraft is close enough for ground control approach (GCA). The pilot then must change frequency, and the ground receiver operating on the GCA frequency would be patched on an omnidirectional antenna.

Another method of eliminating interference is to utilize cardioid antennas which are omnidirectional except for a null over a small horizontal sector. By aligning this null with the azimuth of the undesired signal the interference may be significantly reduced. In a similar manner to the cardioid, many other shaped beam antennas offer similar solutions.

In considering simple changes there is considerably more flexibility for transmitters than for receivers. The most obvious means of eliminating interference is to turn off the interfering transmitter. In those cases where no feasible means of eliminating the interference exists, the on-the-air time must be shared with other radiating equipment. A decision must be made as to which of the equipments is performing the most important function at the time. If the equipment experiencing the interference is considered to be performing a higher priority function, then the interfering transmitter should go off the air. In those cases where the equipment causing the interference is performing the more important function, then the reverse situation is true. In this case the victim may possibly switch to another channel, or use some emergency means of maintaining communications until the culprit has ceased operating. This would, of course, assume the interference to be of short duration.

In some situations, particularly adjacent channel or harmonic adjacent channel interference, where the interference level is marginal, the problem may be eliminated by reducing the power of the interfering signal. This will, of course, reduce the signal between the interfering transmitter and its receiver, but in some cases the reduction in range will be insignificant compared with the advantage gained by freeing another equipment from interference. In addition to reducing power of the culprit transmitter, the reduction may be accomplished by change of transmitter frequency within the pass-band of the receiver, or by a change of antenna polarization.

The addition of hardware and modifications to the transmitters also can significantly reduce the problem of interference. The main emphasis in this area is the reduction of spurious signals. The use of bandpass filters and low pass filters at the transmitter output will reduce spurious and harmonic radiation to a level which eliminate the effects of interference. In some pulse type equipment it is also possible to round off the pulses and thus decrease the bandwidth of the radiated signal, especially well out into the modulation sidebands.



In the case of radar, or other equipment which employ scanning antennas, cut-outs can be installed which prevent radiation in selected sectors and eliminate some interference situations. This may be done if some loss in coverage can be tolerated. The use of directional antennas can significantly improve the EMI situation.

Figure 6-43 is a form prepared for use with the flow diagram for making EMI correction recommendations. The form contains a summary of the recommendations and a block to enter the results of the improvement from each change made. In most situations the improvement can be obtained from the EMI calculation sheet for a particular situation. It can be seen that any change which decreases a value in the "A" Column (+dB) on the EMI calculation sheet (figure 6-1) or increases a value in the "B" Column (-dB) will decrease the interference to noise ratio (line 4.1, figure 6-1.) The decrease in the interference to noise ratio will be equal to the absolute value of the decrease in "A" or increase in "B". For example, decreasing the radiated power of a transmitter (Line 1.1.5) of figure 6-1 from 100 watts to 50 watts will decrease the transmitter power 3 dB. This is a decrease in the "A" Column (+dB) so the I/N ratio is decreased 3 dB. The size of most Naval Shore Stations is such that the distances between the equipments is in the order of 1 to 3 miles. In these short distances the signal attenuations are usually negligible so that cochannel operation will almost always cause an EMI situation. Interference will usually result when an equipment operates on an adjacent channel or on a harmonic frequency of another equipment. Therefore, the most effective and simplest means of reducing EMI problems is through the careful assignment of frequencies.

The development of frequency assignment plans is beyond the scope of this handbook, but the flow diagram presented for use in the rapid frequency sorting process shows the relationship of frequencies that will probably cause interference.

## 6.8 HAZARDS EVALUATION TECHNIQUES

### 6.8.1 The Basic Problem

In paragraph 6.2 a basic interference prediction model was presented as one method of determining the effects of adding equipment to an electromagnetic environment, both upon the equipment itself and upon other equipments existing within the environment. The previous discussion centered upon the interaction between equipments/systems from an interference viewpoint. Some additional questions of equal importance which must be asked during the equipment planning and installation stages are:

- o What potentially hazardous situations are created by adding new sources of electromagnetic radiation to an existing site?
- o Are any hazardous situations created by changing frequencies or operating schedules of existing equipment?
- o What are the potential hazards when adding fuels, ordnance, electronic equipment, and personnel to the vicinity of existing sources of electromagnetic radiation?
- o What protective measures are possible, and what is their effectiveness?

The first question contains an important implication, i.e., can the addition of electromagnetic energy by new equipments re-enforce existing radiation levels to create a hazardous situation, where non-hazardous levels existed previously? The answers to these questions may be found by establishment of a hazards analysis or prediction process.

The basic goal of a hazards analysis is to define those areas within a site that may be considered potentially hazardous to both personnel and materiel by presently accepted safe radiation limits. The practical accomplishment of this goal may be realized by a combination of theoretical, "worst case" calculations and on site measurements of EMR power densities at a given site. For the purposes of analysis, the major source of hazardous electromagnetic energy is emitted from the antennas associated with radar and communications equipment of both low and high power emissions.

Min. S/I Improvement Required for Marginal (Score C) performance: \_\_\_\_\_ dB  
 Preferred S/I Improvement  $\geq \Delta_r S/I$ : \_\_\_\_\_ dB  
 Allowable Methods to Improve (S/I): (check appropriate boxes)

1.  Receiver Fixes Not Involving Hardware Additions

- Increase Frequency Separation from  $\Delta f =$  \_\_\_\_\_ MHz to \_\_\_\_\_ MHz  
 (Present RX \_\_\_\_\_ MHz; New RF \_\_\_\_\_ MHz). Improvement \_\_\_\_\_ dB
- Rotate/change RX Polarization Improvement \_\_\_\_\_ dB
- Antenna Scan Synchronization (TX: \_\_\_\_\_ RPM) (RX: \_\_\_\_\_ RPM)
- Sector Blanking (From \_\_\_\_\_ ° AZ to \_\_\_\_\_ ° AZ) Improvement \_\_\_\_\_ dB
- Pulse Synchronize (From \_\_\_\_\_ PRR to \_\_\_\_\_ PRR) Improvement \_\_\_\_\_ dB
- Other: \_\_\_\_\_ Improvement \_\_\_\_\_ dB
- Time Share "On-the-Air": \_\_\_\_\_

Total Improvement in S/I:  $\Delta_1 S/I =$  \_\_\_\_\_ dB  
 Is  $\Delta_1 S/I \geq \Delta_r S/I$  ? Yes: No-Go on To No. 2.

2.  Transmitter Fixes Not Involving Hardware Additions

- Increase Frequency Separation from  $\Delta f =$  \_\_\_\_\_ MHz to \_\_\_\_\_ MHz  
 (Present TX \_\_\_\_\_ MHz; New Frequency \_\_\_\_\_ MHz). Improvement \_\_\_\_\_ dB
- Sector Blanking (From \_\_\_\_\_ ° AZ to \_\_\_\_\_ ° AZ). Improvement \_\_\_\_\_ dB
- Rotate/change Polarization Improvement \_\_\_\_\_ dB
- Time Share "On-the-Air": \_\_\_\_\_ Improvement \_\_\_\_\_ dB
- Other: \_\_\_\_\_ Improvement \_\_\_\_\_ dB

Total Improvement in S/I:  $\Delta_2 S/I =$  \_\_\_\_\_ dB  
 Accumulative Improvement:  $\Delta S/I = \Delta_1 S/I + \Delta_2 S/I =$  \_\_\_\_\_ dB  
 Is  $\Delta S/I \geq \Delta_r S/I$  ? Yes: No - Go on to No. 3.

3.  Receiver Fixes Involving Hardware Additions

- Pulse Width Discrimination ( \_\_\_\_\_  $\mu$  sec.) Improvement \_\_\_\_\_ dB
- PRR Discrimination ( \_\_\_\_\_ PPS) Improvement \_\_\_\_\_ dB
- Band Pass Filter / Preselector Improvement \_\_\_\_\_ dB
- Low Pass Filter Improvement \_\_\_\_\_ dB
- Other: \_\_\_\_\_ Improvement \_\_\_\_\_ dB

Total Improvement in S/I:  $\Delta_3 S/I =$  \_\_\_\_\_ dB  
 Accumulative Improvement:  $\Delta S/I = \sum_n \Delta_n S/I$  \_\_\_\_\_ dB  
 Is  $\Delta S/I \geq \Delta_r S/I$  ? Yes: No - Go on to No. 4.

4.  Transmitter Fixes Involving Hardware Additions

- Harmonic Suppression (Low Pass Filter) Improvement \_\_\_\_\_ dB
- Modulation Sideband Reduction  
 Band Pass Filter Improvement \_\_\_\_\_ dB  
 Pulse Rounding Improvement \_\_\_\_\_ dB
- Other: \_\_\_\_\_ Improvement \_\_\_\_\_ dB

Total Improvement in S/I:  $\Delta_4 S/I$  \_\_\_\_\_ dB  
 Accumulative Improvement:  $\Delta S/I = \sum_n \Delta_n S/I$  \_\_\_\_\_ dB

AIAF 248

Figure 6 - 43. Recommendation(s) for EMI Suppression

### 6.8.2 On-Axis Power Densities

It was previously stated that a large aperture antenna can be characterized by two major regions of radiation called the Fresnel region, or near field, and the Fraunhofer region, or far field. The Fresnel region was defined as that portion of the emitted field lying between a wavelength ( $\lambda$ ) from the antenna and a distance given by  $2D^2/\lambda$ , where D equals the antenna diameter or, in the case of rectangular antennas, the largest linear dimension. The far field region was stated to be that portion of the field extending from the end of the Fresnel region to infinity. The evaluation of on-axis power densities in the far zone is relatively simple since both gain and antenna radiation pattern (or beamwidth in degrees at the half-power points) are independent of the distance from the antenna. Thus, the far field on-axis power density is given by the Friis free-space transmission formula:

$$W_d = \frac{P_t G_o}{4\pi (d)^2} \quad (6-29)$$

where:

- $W_d$  = power density at a given on-axis point in  $\text{mW}/\text{cm}^2$
- $G_o$  = Transmitting antenna maximum far-field gain
- $P_t$  = Average power transmitted in mW.
- $d$  = Distance from antenna to the point in question in cm.

If the gain is not known it may be calculated from:

$$G_t = \frac{4\pi A_e}{\lambda^2} \quad (6-30)$$

where:

- $A_e$  = the effective aperture of the antenna and is defined as:

$$A_e = \frac{P_L}{W} \quad \text{meter}^2 \quad (6-31)$$

where:

- $P_L$  = Power into the load (watts) W
- $W$  = Power density of the incident wave ( $\text{watts}/\text{m}^2$ )

Equation 6-29 does not include the effects of ground reflection which, if present, could cause a value of power density that is four times the free-space value. For reflection from smooth earth, as illustrated in figure 6-44, equation 6-29 may be modified by the following expression:

$$W'_d = 4W_d \sin^2 \left( \frac{h_t h_p}{14.67\lambda Z} \right) \quad (6-32)$$

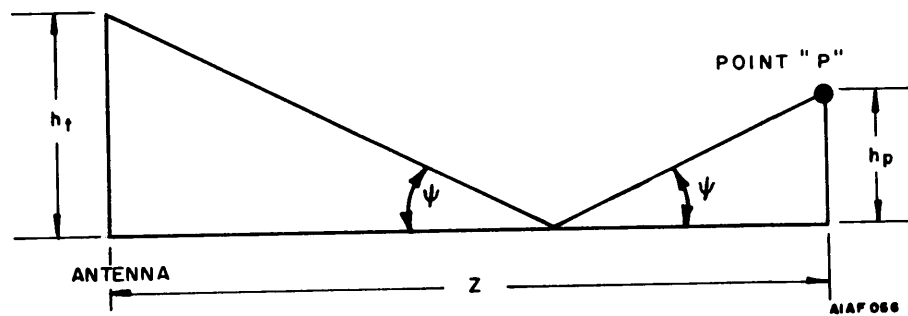

Figure 6 - 44. Smooth-Earth Reflection

where:

- $W'_d$  = power density at point p in  $\text{mW}/\text{cm}^2$
- $W_d$  = power density as given by equation 6-29
- $h_t$  = antenna height above ground in feet
- $h_p$  = height of point p from ground in feet
- $\lambda$  = wavelength in centimeters
- $Z$  = distance of point p from antenna in statute miles

Equation 6-32 should not be used for distances beyond the radio horizon and frequencies below 30 MHz. For vertical polarization the grazing angle  $\psi$ , as shown in figure 6-44 is limited as follows:

$$\begin{aligned} \text{at } 100 \text{ MHz } \psi &\leq 1^\circ \\ \text{at } 5000 \text{ MHz } \psi &\leq 5^\circ \end{aligned}$$

$$\psi = \tan^{-1} \frac{h_t + h_p}{Z}$$

$h_t$ ,  $h_p$  and  $Z$  are in same units

As frequency increases, the allowable grazing angle goes up. For horizontal polarization the grazing angle does not restrict the use of equation 6-32.

By substituting  $W_d = 10 \text{ mW/cm}^2$  in equation 6-29, and solving for  $d_{\min}$ , the minimum safe-on-axis distance for personnel in the far zone may be found. Thus:

$$d_{\min} = \sqrt{\frac{P_t G_o}{40\pi}} \quad (\text{cm}) \quad (6-33)$$

$$\text{or } d_{\min} = 0.00292 \sqrt{P_t G_o} \quad \text{feet.} \quad (6-34)$$

where:

$$P_t = \text{Average power output in mW.}$$

If the peak power output is known, as for radar sets, average power can be determined by multiplying the peak power by the radar duty cycle:

$$P_t (\text{Average}) = P_t (\text{peak} \times \text{d.c.}) \quad (6-35)$$

where :

$$\begin{aligned} \text{d.c.} = \text{duty cycle} &= \frac{\text{Pulse Width (msec)}}{\text{Pulse Train Period (msec)}} \\ &= \text{Pulse width} \times \text{pulse repetition frequency.} \end{aligned}$$

In the Fresnel region, antenna gain and pattern are no longer constant, with both parameters being functions of the distance from the antenna. On-axis power densities may be calculated as follows:

a. Large Aperture Rectangular Antennas. For this type of antenna, a gain correction factor may be found which depends on the distance from the antenna and the type of illumination, or energy distribution across the antenna aperture. Curves of such correction factors are given for common illuminations in figures 6-45 through 6-49, with the antenna maximum linear dimension plotted as a parameter. If the type of illumination is not known, it may be estimated by the following process:

Calculate a constant R defined by:

$$R = \frac{\pi \theta_H H}{180 \lambda} \quad \text{or} \quad \frac{\pi \theta_V V}{180 \lambda} \quad (6-36)$$

where:

$\theta_H$  = Beamwidth at half power points in H direction in degrees

$\theta_V$  = Beamwidth at half power points in V direction in degrees

H, V correspond to horizontal and vertical antenna dimensions

$\lambda$  = Wavelength in same units as H and V

Once R has been calculated, table 6-12 may be used to estimate the illumination. Note that the table is based on the assumption that the H and V illuminations are separable.

Table 6-12. Rectangular Apertures

LIMITS OF R	ESTIMATED ILLUMINATION
$0.88 \leq R < 1.2$	Uniform
$1.2 \leq R < 1.45$	Cosine
$1.45 \leq R < 1.66$	Cosine <sup>2</sup>
$1.66 \leq R < 1.93$	Cosine <sup>3</sup>
$1.93 \leq R < 2.03$	Cosine <sup>4</sup>
ILLUMINATION	F <sub>H</sub> OR F <sub>V</sub>
Uniform	1,000
Cosine	0.810
Cosine <sup>2</sup>	0.667
Cosine <sup>3</sup>	0.575
Cosine <sup>4</sup>	0.515

A check on the validity of the estimated aperture illumination can be made by computing the antenna efficiency from its illumination constants. This is done by making use of the fact that the far field gain of a rectangular aperture antenna with separable distributions is given by

$$G_o = \frac{4\pi A F_H F_V K}{\lambda^2} \quad (6-37)$$

where:

- A = Physical area of aperture
- $\lambda$  = Wavelength in same linear units as A
- F<sub>H</sub> = Correction factor depending on H direction illumination
- F<sub>V</sub> = Correction factor depending on V direction illumination
- K = Efficiency

The correction factors, F<sub>H</sub> and F<sub>V</sub>, depending on illumination, are given in table 6-12.

Rearranging equation 6-37 we have, for the antenna efficiency:

$$K = \frac{G_o \lambda^2}{4\pi A F_H F_V} \quad (6-38)$$

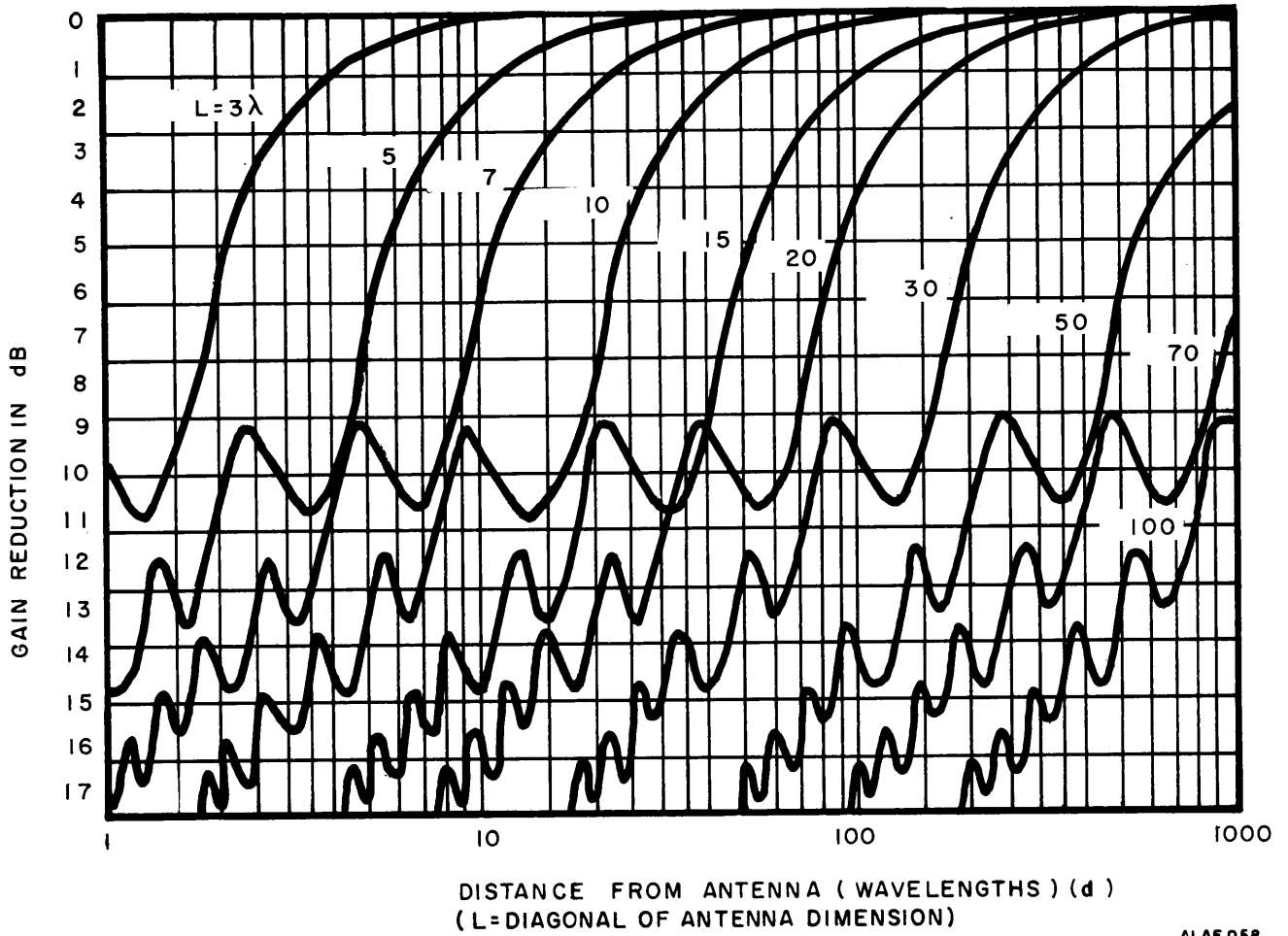

AI AF 058

Figure 6 - 45. Fresnel-Region Gain - Correction for Uniform Illumination

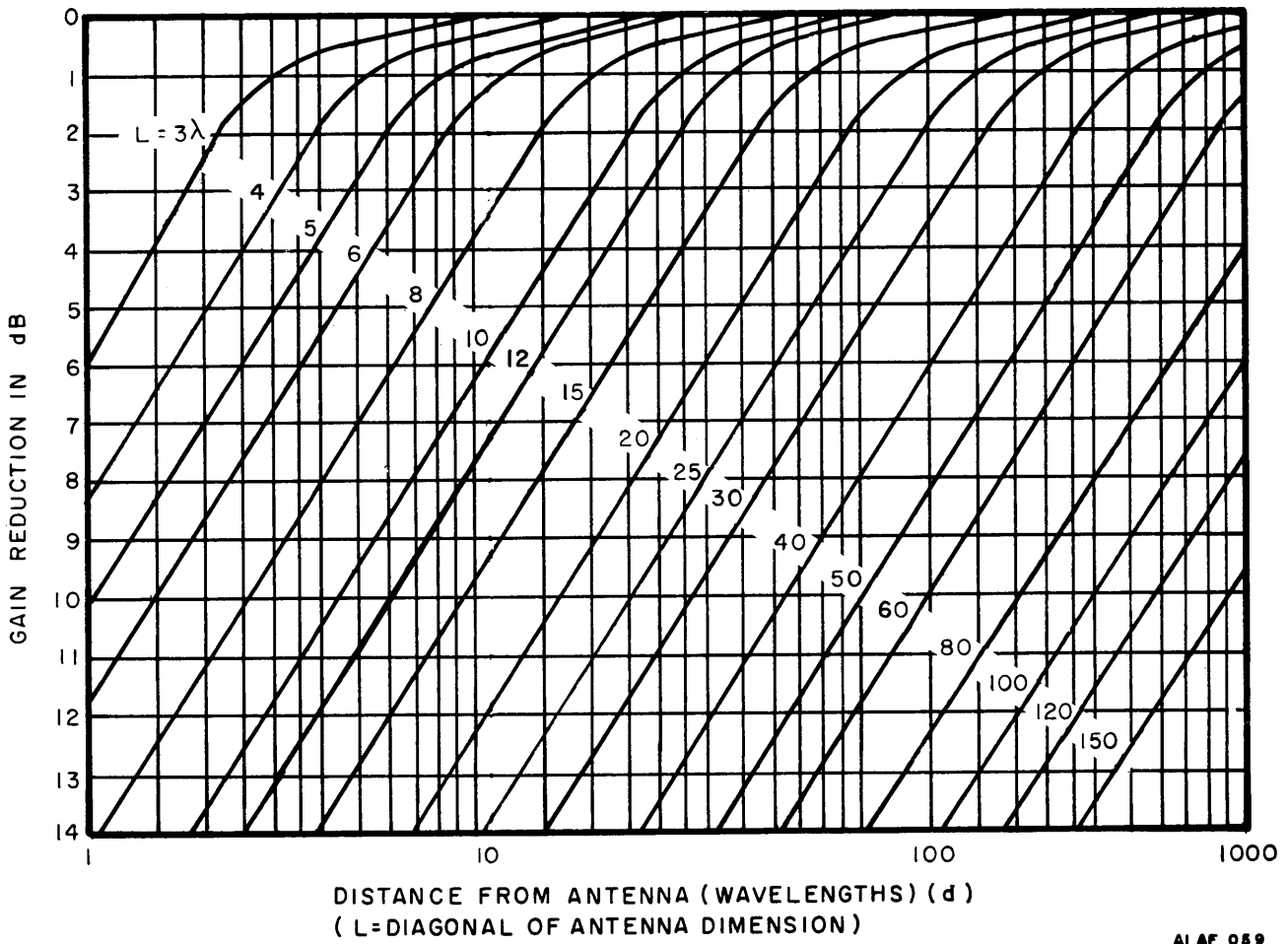

AI AF 059

Figure 6 - 46. Fresnel-Region Gain - Correction for Cos Illumination



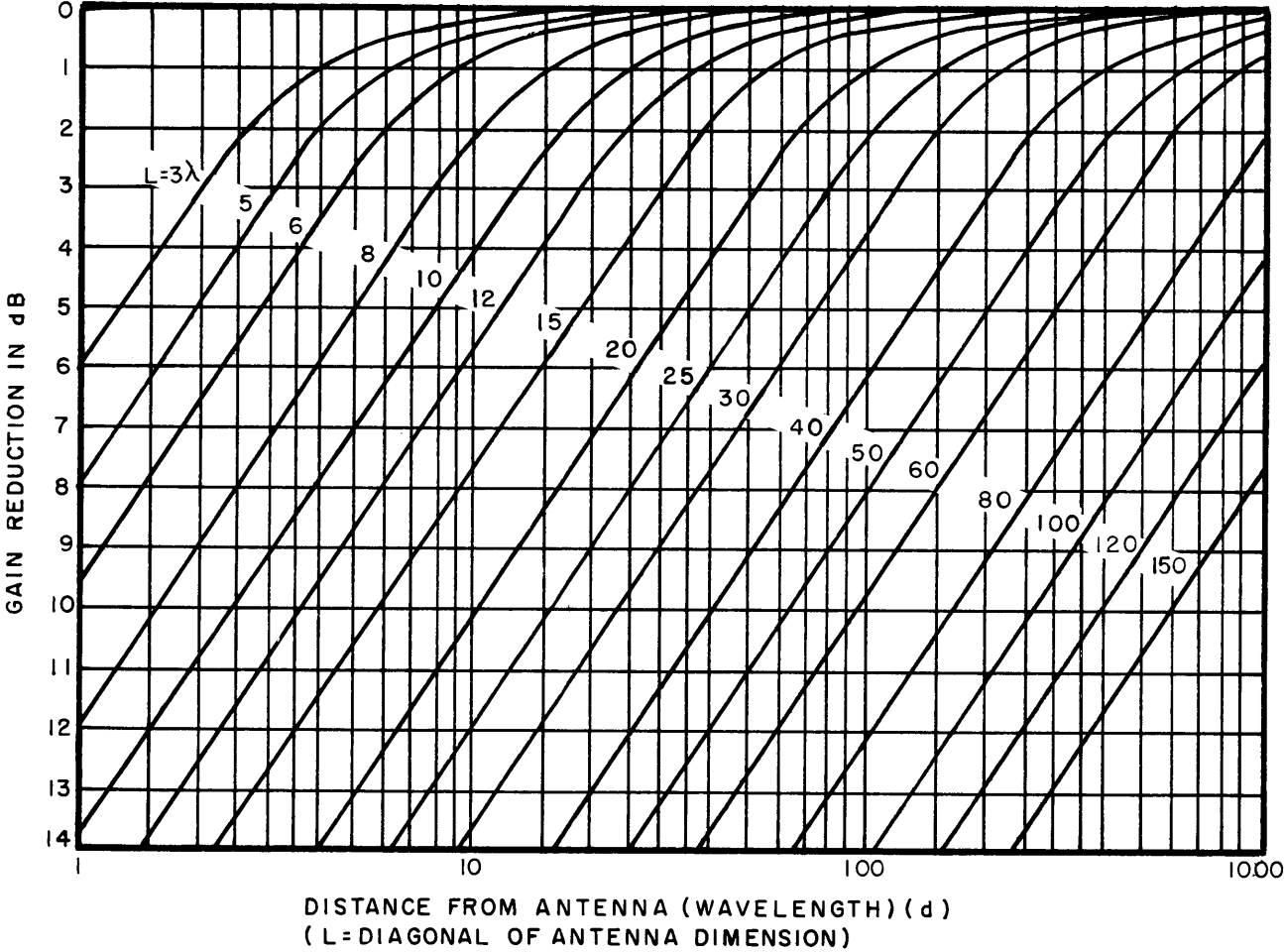

AI AF 060

Figure 6 - 47. Fresnel-Region Gain - Correction for  $\text{Cos}^2$  Illumination

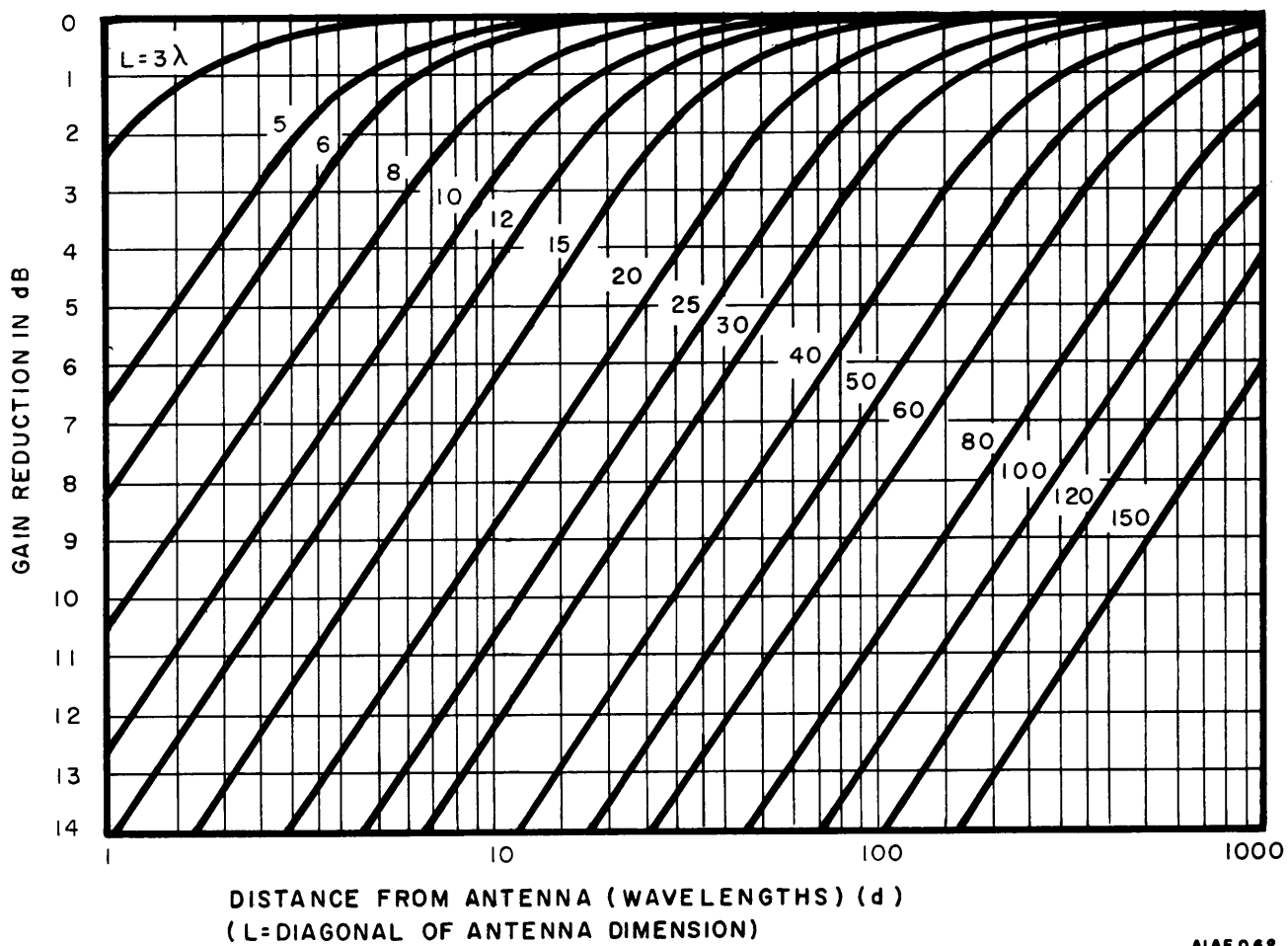

AIAF 062

Figure 6 - 48. Fresnel-Region Gain - Correction for  $\cos^3$  Illumination

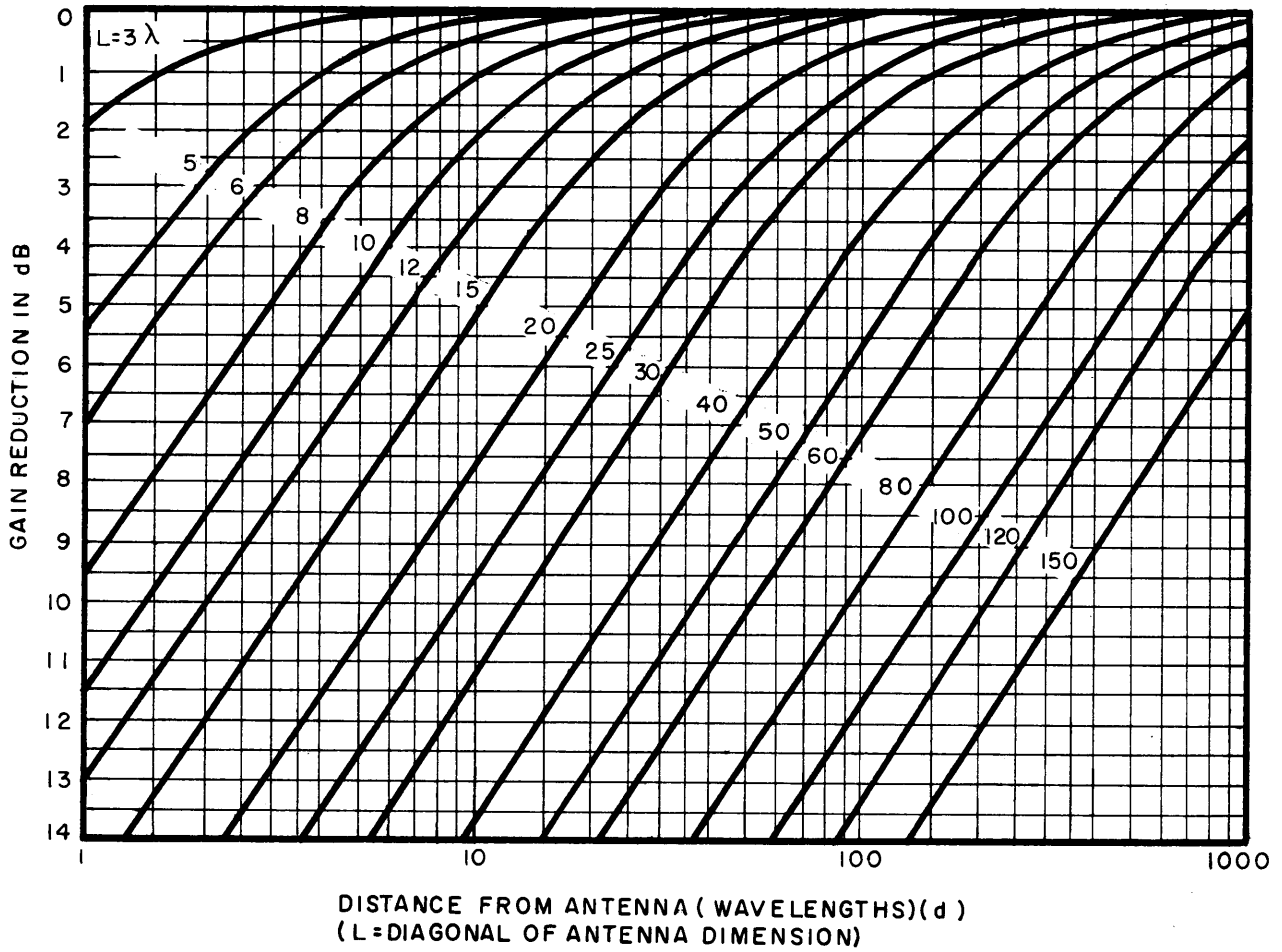

AI AF 061

Figure 6 - 49. Fresnel-Region Gain - Correction for  $\text{Cos}^4$  Illumination

If the computed efficiency is reasonable, then it is safe to assume that the aperture illuminations determined as above are satisfactory. A reasonable criterion for efficiency can be given as  $0.5 \leq K \leq 0.9$ .

When the constant R is found to be on the borderline between two orders of illumination, the higher order should be selected initially since this will give a higher (and more hazardous) power density. If this choice causes the efficiency to be too high, then the next lower order should be used.

Once the aperture illuminations have been estimated for both vertical and horizontal illuminations, and checked to be plausible, the Fresnel region gain corrections may be found from the appropriate figures 6-45 through 6-50. The two correction factors are then subtracted from  $G_o$ , the far field gain to give the gain in the Fresnel region. Power density is then obtained from:

$$W_d = \frac{P_t G_f}{4\pi d^2} \quad (\text{mW/cm}^2) \quad (6-39)$$

where:

$G_f$  = Corrected far field gain

b. Large Aperture Circular Antennas. Calculation of power densities in the Fresnel region for this type of antenna follows the same general procedure as given for rectangular antennas. After R has been calculated, table 6-13 is used to estimate the illumination. The efficiency is then calculated as a check on the illumination using the appropriate value of F from the table in equation 6-38. Power density at a given on-axis point within the Fresnel region is given by the free-space, far field formula multiplied by an appropriate correction factor. The correction factor is found in the chart given in figure 6-50.

Table 6-13. Circular Apertures

LIMITS OF R	ESTIMATED ILLUMINATION
$1.02 \leq R < 1.27$	Uniform
$1.27 \leq R < 1.47$	$(1-r^2)$ taper
$1.47 \leq R < 1.65$	$(1-r^2)^2$ taper
$1.65 \leq R < 1.81$	$(1-r^2)^3$ taper
Greater than 1.81	$(1-r^2)^4$ taper
ILLUMINATION	F
Uniform	1.00
$(1-r^2)$ taper	0.75
$(1-r^2)^2$ taper	0.56
$(1-r^2)^3$ taper	0.44
$(1-r^2)^4$ taper	0.36

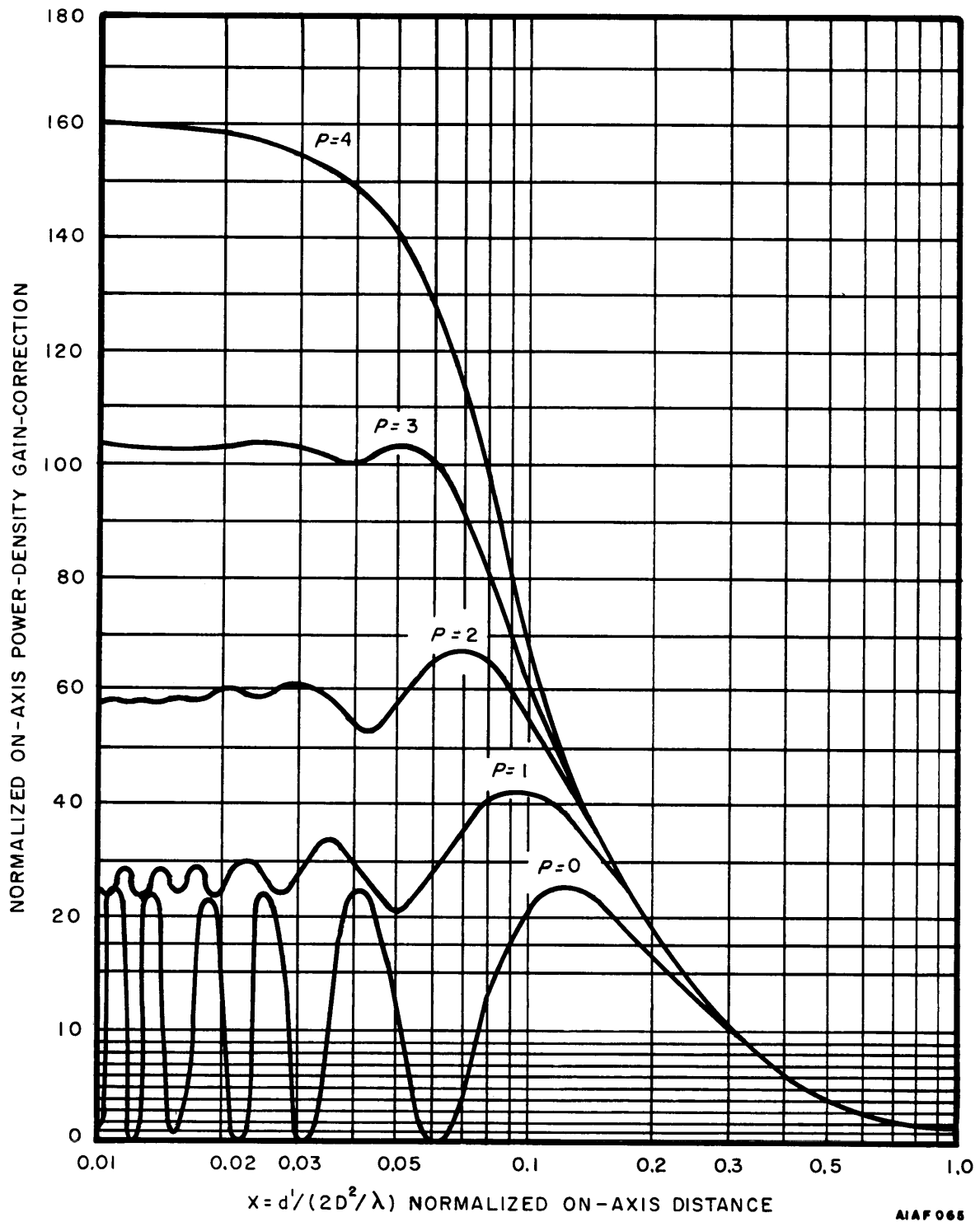

Figure 6 - 50. Normalized On-Axis Power-Density Curves for Circular Aperture  $(1-r^2)^p$  Tapers

Calculate the distance to the end of the Fresnel region by using  $2D^2/\lambda$ , where D equals the antenna diameter. Divide d, the distance from the antenna to the point of interest, by the value found for  $2D^2/\lambda$ , to give the normalized on-axis distance: this is the parameter plotted as the abscissa on the graph shown in figure 6-50. The correction factor is then obtained from the curve plotted for the previously estimated type of illumination.

### 6.8.3 Off-Axis Power Densities

The exact calculation of power densities off the main beam axis is a complex mathematical task, since such calculation must "predict" the exact three-dimensional nature of the radiation pattern, including significant side and rear-lobe structures whose shapes are dependent upon such parameters as antenna structural variations, type of construction, aperture feed phase errors, and the presence of obstacles near the antenna.

For circular aperture antennas having  $(1-r^2)$  taper, an approximate solution for the secondary pattern power-density contours is given by: (see figure 6-51).

$$W_r = W_d \cos^2 \left[ \frac{1.27 D}{\lambda \alpha} \tan^{-1} \frac{r}{d} \right] \quad (6-40)$$

where:

$W_r$  = Power density at a point off the main beam axis - (mW/cm<sup>2</sup>)

$W_d$  = Power density on the beam axis at the point of connection of the normal from the off-axis point (d).  
- (mW/cm<sup>2</sup>)

D = Antenna diameter (feet)

$\lambda$  = Wavelength (feet)

$\alpha$  = A Fresnel region connection factor (numerical)

r = Distance normal to antenna axis from off-axis point (feet)

d = Distance from antenna aperture along main axis (feet)

$W_d$  may be found from:

$$W_d = 26.1 \frac{P_t G_o}{4\pi d^2} \left[ 1 - \frac{16x}{\pi} \sin \frac{\pi}{8x} + \frac{128x^2}{\pi^2} \left( 1 - \cos \frac{\pi}{8x} \right) \right] \quad (6-41)$$

where:

$$x = \frac{\lambda d}{2D^2}$$

The beam broadening factor  $\alpha$  is given by:

$$\alpha = \pi / 16x \sqrt{1 - \frac{16x}{\pi} \sin \frac{\pi}{8x} + \frac{128x^2}{\pi^2} \left( 1 - \cos \frac{\pi}{8x} \right)} \quad (6-42)$$

By rearranging equation 6-40 and letting  $W_r = 10$  mW/cm<sup>2</sup>, the safe distance power density envelope is found:

$$r = d \tan \left[ \frac{\lambda \alpha}{1.27} D \cos^{-1} \sqrt{\frac{10}{W_d}} \right] \quad (6-43)$$

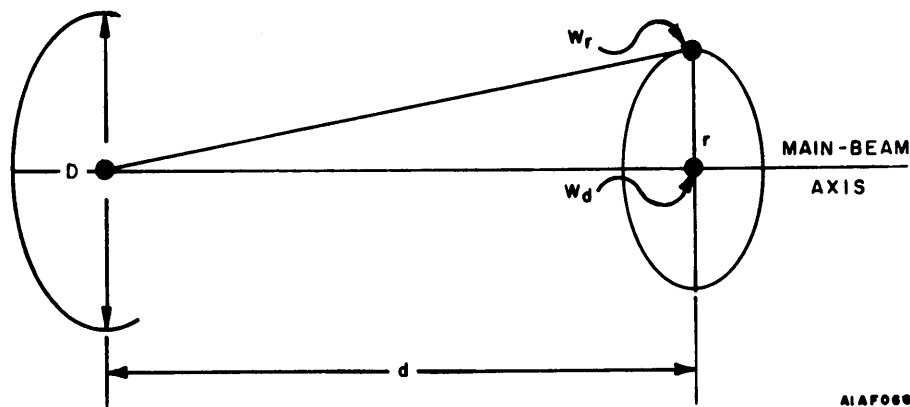

Figure 6 - 51. Calculation of Off-Axis Power Densities for Circular Aperture,  $1-r^2$  - Taper Antennas

Figure 6-52 is a nomogram which may be used for quick solutions of both on-axis and off-axis safe distances. Investigation of the preceding equations reveals that there is a direct relationship between off-axis safe distances and transmitted average power over a range of aperture diameter from about 10 to 150 wavelengths.

#### 6.8.4 Ordnance Power Transfer

A worst case analysis may be obtained for electroexplosive devices by treating the lead-in wiring to an EED bridge as a linear antenna and determining the induced current under ideal RF energy transfer conditions. Such an analysis necessarily omits those protective measures which are normally present in a weapons system, e.g., shielded wiring and shielded enclosures. For mathematical analysis of power transfer problems see NAVWEPS OD 30393 and NAVAIR 16-1-529. Blasting caps may be analyzed in a similar manner. See ANSI C-95.4.

#### 6.8.5 Equipment Power Transfer

The analysis of RF energy transfer to C-E equipments may be accomplished in a manner similar to that previously outlined for ordnance. Because of the multitude of equipment types with each having its own particular damage threshold, and because of the many modes of energy transfer, a general solution is not possible. Instead, a worst-case configuration may be assumed and the energy coupled to the equipment determined. For example, assume that a piece of transistorized equipment is connected to some other equipment by a poorly shielded cable two meters long. Under worst-case conditions the cable may be viewed as an antenna operating into a matched load, and having an effective aperture of about two square meters at the VHF/UHF bands. Assume that the cable is exposed to a radar RF field having a power density of 5 mW/cm<sup>2</sup> and a pulse repetition rate of 200 pulses per second. The energy collected per pulse is then given by:

$$E = \frac{A_e W_t}{f} \quad (\text{joules}) \quad (6-44)$$

**NAVELEX 0101,106**

where:

E = Energy per pulse

$W_t$  = Average field power density in watts/m<sup>2</sup>

f = Pulses per second

$A_e$  = Effective area in meter<sup>2</sup>

Therefore,

$$E = \frac{2 \times 50}{200} = 0.5 \text{ joules.}$$

Since typical burnout levels for semiconductors are of the order of  $10^{-6}$  to  $10^{-4}$  joules on a single pulse basis, the calculation reveals a potentially hazardous situation.



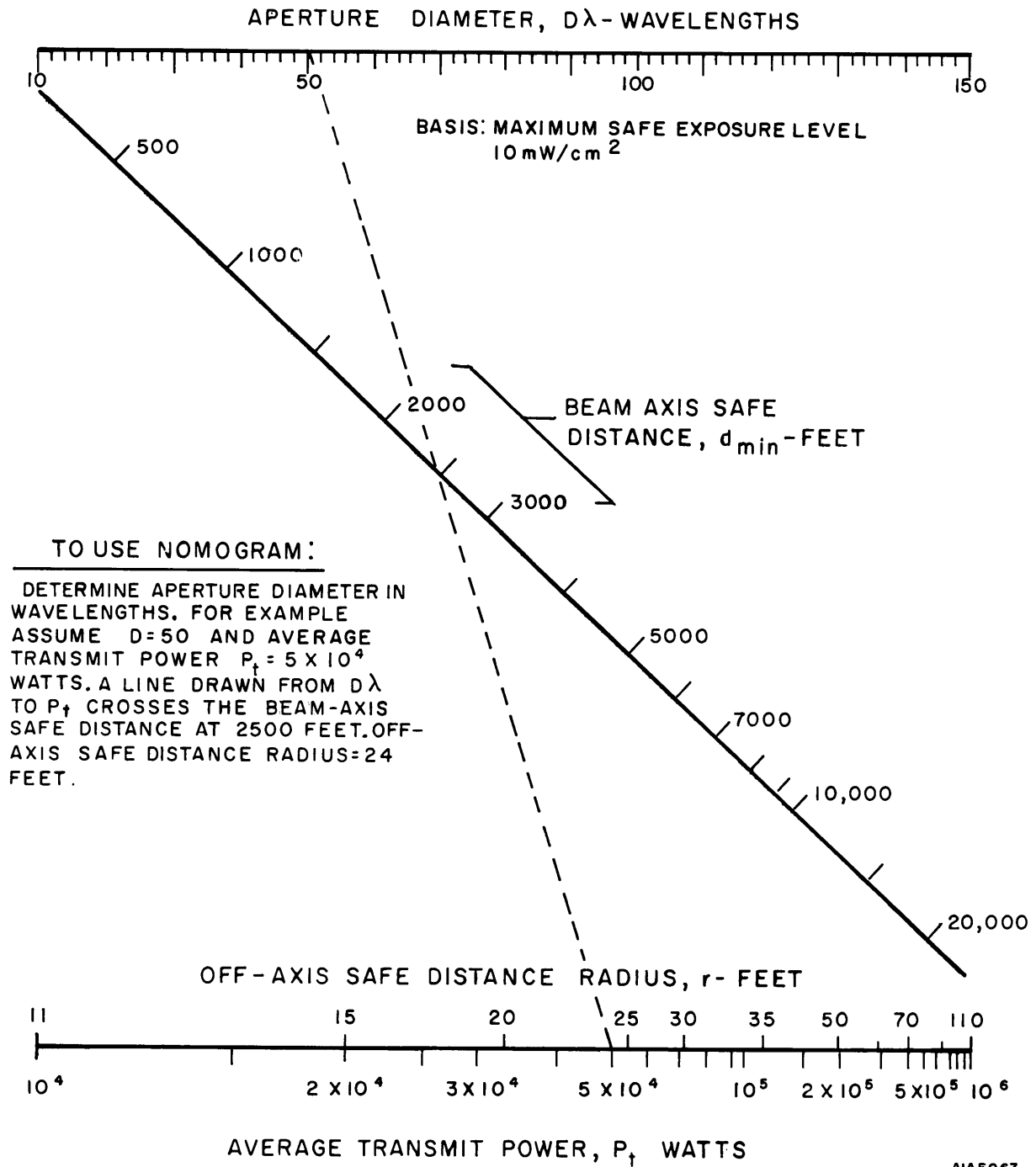

Figure 6 - 52. Microwave Radiation Safe-Distance Nomogram

